



Modicon X80 modules platform

The common platform of modules for
Modicon M580 and M340 PLCs/PACs



Modicon

Discover Modicon

Industrial Edge control for IIoT

Modicon IIoT-native edge controllers manage complex interfaces across assets and devices or directly into the cloud, with embedded safety and cybersecurity. Modicon provides performance and scalability for a wide range of industrial applications up to high-performance multi-axis machines and high-available redundant processes.

Explore our offer

- Modicon HVAC Controllers
- Modicon PLC
- Modicon Motion Controllers
- Modicon PAC
- Modicon I/O
- Modicon Networking
- Modicon Power Supply
- Modicon Wiring
- Modicon Safety

Life Is On

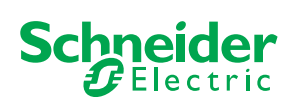

Quick access to product information

Get technical information about your product

References

Modicon TM3
I/O expansion modules for Modicon controllers
Analog I/O modules

Number and type of channels	Input range	Resolution	Aperture time (typical)	Reference	Weight (kg)
2 voltage/current inputs	-15...+10 VDC 0...20 mA r.t. 20 mA	16,000 or 10,000 r.s.g.	0.005 s 0.005 s	TM3AI2H TM3AI2HG	0.110 0.100
4 voltage/current inputs	-15...+10 VDC 0...20 mA r.t. 20 mA	12,000 or 10,000 r.s.g.	0.005 s 0.005 s	TM3AI4 TM3AI4G	0.100 0.090
4 voltage/current or temperature inputs (T)	-15...+10 VDC 0...20 mA r.t. 20 mA	16,000 or 10,000 r.s.g.	0.005 s 0.005 s	TM3AI4T TM3AI4TG	0.110 0.100
4 differential temperature inputs (T)	0...100 °C 0...100 °F	16,000 or 10,000 r.s.g.	0.005 s 0.005 s	TM3TI4 TM3TI4G	0.110 0.100
8 self-supply	-15...+10 VDC	12,000 or 10,000 r.s.g.	0.005 s 0.005 s	TM3I8 TM3I8G	0.110 0.100

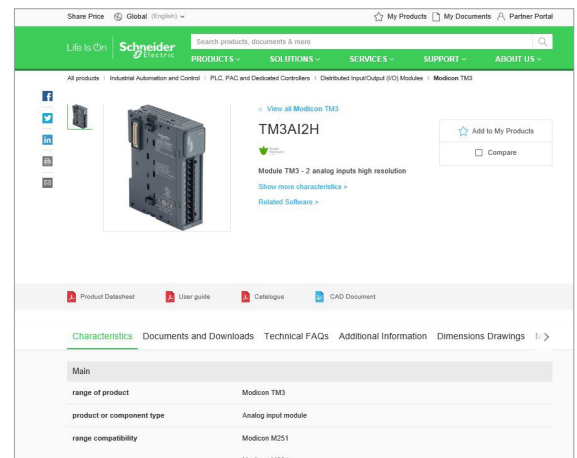

Each commercial reference presented in a catalog contains a hyperlink. Click on it to obtain the technical information of the product:

- Characteristics, Dimensions and drawings, Mounting and clearance, Connections and schemas, Performance curves
- Product image, Instruction sheet, User guide, Product certifications, End of life manual

Find your catalog



- > With just 3 clicks, you can access the Industrial Automation and Control catalogs, in both English and French
- > Consult digital automation catalogs at [Digi-Cat Online](#)

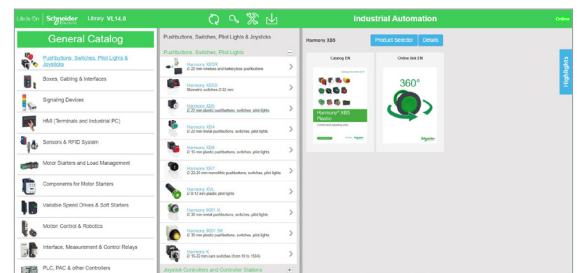

- Up-to-date catalogs
- Embedded product selectors, 360° pictures
- Optimized search by commercial references

Select your training



- > Find the right [Training](#) for your needs on our Global website
- > Locate the training center with the selector tool, using this [link](#)

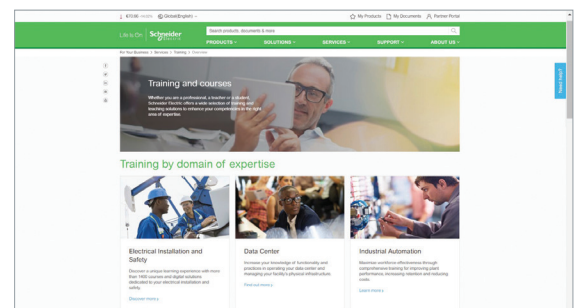

General contents

Presentation.....	1
Racks	2
Power supplies	3
I/O modules.....	4
Safety.....	5
Expert modules	6
I/O expansion modules	7
Communication modules	8
Dedicated parts for severe environments	9
Standards and certifications, index.....	10

In this catalog, all instances of words that refer to Safety without precision must be understood as referring to "Functional Safety" according to IEC 61508 and IEC 61511.

Schneider Electric's IoT-enabled, plug-and-play, open, secure, interoperable architecture and platform, in Industries, Infrastructures, Data Centers, and Buildings.

Innovation at every level

EcoStruxure is based on a three-tiered technology stack delivering innovation at every level, from connected products to edge control and apps, analytics, and services.

Together with our hybrid segments approach, this enhances your value around safety, reliability, operational efficiency, sustainability, and connectivity across 6 domains of expertise:

- Power
- IT
- Building
- Machine
- Plant
- Grid

Dedicated architectures and IoT

We tailor our solutions in the form of dedicated reference architectures for plants:

- Management systems
- Power systems
- Data center systems
- Industrial plant and machine systems
- Smart grid systems

The Industrial Internet of Things (IIoT) gives an additional boost to technologies. That's why we provide our customers with an IoT-enabled architecture and platform offering simple, reliable, productive, and cost-efficient solutions.

Cybersecurity solutions

Robust cybersecurity protection is a must, and Schneider Electric's solutions can deliver it, regardless of business type or industry.

The vendor-agnostic services provided by our skilled professionals help to protect your entire critical infrastructure. We help to assess your risk, implement cyber-specific solutions, and maintain your onsite defenses over time, while integrating appropriate IT policies and requirements.

This is our difference and your advantage.

Enhanced safety

With the release of M580 Safety, Schneider Electric further expands the EcoStruxure platform.

This consolidates our position as one of the most trusted industrial safety vendor, with thousands of Modicon and Triconex safety systems protecting the most critical industrial processes globally.

EcoStruxure™ for Plant
Innovation At Every Level



*The Schneider Electric industrial software business and AVEVA have merged to trade as AVEVA Group plc, a UK listed company. The Schneider Electric and Life is On trademarks are owned by Schneider Electric and are being licensed to AVEVA by Schneider Electric.

- Overview [page 1/2](#)
- Composition [page 1/6](#)
- Architectures, software configuration [page 1/7](#)
- Product compatibility according to network architecture [page 1/8](#)



Modicon X80 modules

The Modicon X80 modules platform serves as a common platform for Modicon M340, Modicon M580 PACs, and X80 RIO and DIO drops. This common platform means that a much smaller stock of spare parts needs to be held, and maintenance and training costs are significantly reduced. A common configuration tool is used for all PAC modules using EcoStruxure Control Expert (1) with a high level of services such as bit forcing and structured device DDT. This platform offers a wide choice of Schneider Electric modules (discrete, analog, expert, and communication).

Common modules platform for Modicon M340 and M580

Compact

- > The Modicon X80 modules platform features the latest I/O technology, making it extremely compact.
- > It has smaller cabinet dimensions, with up to 64 discrete I/O for some modules.
- > High density



Modicon X80 modules platform

Robust

- > Offering more than required by the standards

Characteristics	Modicon X80 modules platform	IEC standards Values required by
Mechanical constraints	Levels reached	IEC 60068-2
Shock	30 g	> 15 g
Vibrations	3 g	> 1 g
Electrical immunity	Levels reached	IEC 61131-2
Radiated field	15 V/m	> 10 V/m
Electrostatic discharges by contact	6 kV	> 4 kV
Environmental immunity	Working values	IEC 61131-2
Temperature	0...60 °C/32... 140 °F	> 5...55 °C/41... 131 °F
Modicon X80 ruggedized offer	-25...70 °C/32... 158 °F	> 5...55 °C/41... 131 °F
Corrosive environments (coated versions)		Class Gx, 3C4, Kb, 3S4, 3B2

Sustainable

- > Common X80 modules reduce training and maintenance costs
- > Hot swappable
- > Existing solutions for migrating from legacy I/O to the Modicon X80 modules platform
- > Green Premium Eco Label

(1) EcoStruxure Control Expert software continues the Unity Pro range of software and corresponds to versions ≥ 14 of Unity Pro.



M580 Safety

Regulatory requirements



Good practices dictate that control systems must be designed to keep process control functions separate and operationally independent from safety functions. This is usually achieved using a controller for the process and a separate system for safety.

Clear distinction between safety and process

Our solution to combine safety and process management in one application

- > Dual processing capability to control safety and process functions independently
- > Unifying independent plant safety and process control to help protect the entire operating environment
- > Minimized impact of standard process failure on plant safety, its people, and assets
- > No need to design, install, and maintain separate safety systems
- > Same tools, wiring methods, and I/O structures as Modicon M580 controller

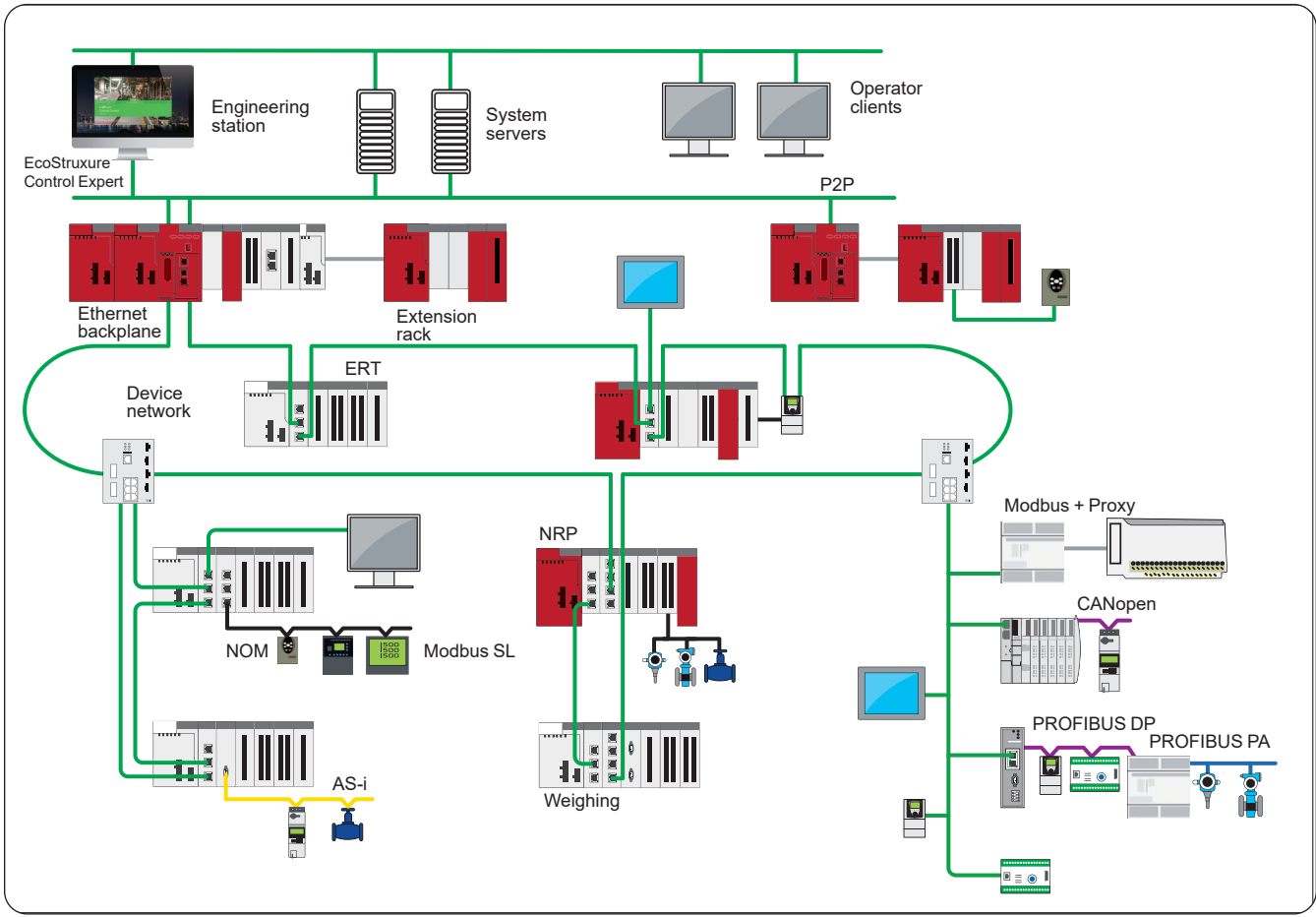

Typical common Safety architecture with Modicon M580 Safety

+ Combining standard process and safety in a single M580 project



Certifications and standards

Depending on the model, Modicon X80 modules comply with the following standards:

- > International certifications: CE, UL, CSA, RCM, EAC
- > Certified for Hazardous Location Class I Division 2 Groups ABCD and for ATEX/IECEx zone 2/22 (depending on the model, see pages [10/2](#) to [10/9](#))
- > Merchant navy: IACS E10 and agencies: ABS, BV, DNV, GL, LR, RINA, RMRS, and CCS
- > Power generation market: IEC 61000-6-5, IEC 61850-3
- > See pages [10/2](#) to [10/9](#) for more information.

International certifications



Merchant navy



Hazardous locations



Functional safety





Market segments

> The Modicon PAC platform (M340, M580, X80) applies to the following market segments:



1



Modicon X80 modules platform with Modicon M580 processor



Modicon X80 modules platform with Modicon M340 processor



Modicon X80 Fiber converter module with X80 Remote I/O drop adapter



Ethernet Modbus/TCP DIO drop with X80 Peripheral remote I/O adapter

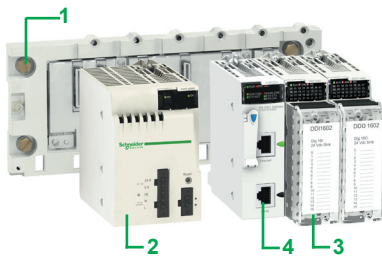

DIA6ED2151012EN



DIA6ED2110104EN

Presentation

The Modicon X80 modules platform serves as the common base for automation platforms by simply adding a dedicated M340 or M580 processor (1). It may also:

- form part of a Quantum and Modicon M580 Ethernet I/O architecture as an Ethernet RIO (EIO) drop with X80 Remote I/O drop adapter
- form an Ethernet Modbus/TCP DIO drop with X80 Peripheral remote I/O adapter

The Modicon X80 modules platform is available in single-rack or multi-rack configuration. One Modicon X80 drop may support two racks separated by a cumulative distance of up to 30 m/98 ft.

This platform, common to several automation platforms, can reduce maintenance and training costs as it comprises:

- a single range of spare parts in stock
- training common to several PLCs

Based on the latest I/O technology, the Modicon X80 modules platform offers:

- high-quality ruggedness and compactness
- compliance with international certifications (ATEX, IEC, etc.)
- a wide selection of modules: discrete or analog I/O modules, expert modules, communication modules, etc.

This platform is programmed and configured using EcoStruxure Control Expert (2) software.

Bit forcing simplifies simulation and structured data simplifies diagnostics.

Description

Modicon X80 modules platform

- 1 X-bus racks with 4, 6, 8, or 12 slots or Ethernet + X-bus racks with 4, 8, or 12 slots for single power supply, and Ethernet + X-bus racks with 6 or 10 slots for dual power supply
- 2 AC or DC power supply modules
- 3 Discrete and analog I/O modules

X80 offer extends to:

- **X80 Expert modules** such as counter, motion control, SSI encoder, time-stamping, frequency input modules, and additional TPP (3) module for weighing
- **X80 Communication modules** for AS-Interface, Modbus, CANopen, PROFIBUS DP communication, and additional devices such as fiber converter modules and Ethernet network switch module
- **X80 I/O expansion modules:** Remote I/O drop and Peripheral remote I/O drop adapters

Note: In this catalog, X80 Expert modules, X80 Communication modules (as listed above), and X80 I/O expansion modules are described, whereas M580 automation platform catalog presents the following additional communication modules:

- Modbus/TCP and EtherNet/IP network module (**BMENOC0301**)
- Ethernet FactoryCast module (**BMENOC0311**)
- Ethernet control router (**BMENOC0321**)
- IEC 61850 module (**BMENOP0300**)
- Ethernet Global Data module (**BMXNGD0100**)
- OPC UA module (**BMENUA0100**)
- RTU and Advanced RTU modules (**BMXNOR0200H** and **BMENOR2200H**) (4)

Treatment for severe environments

With “ruggedized” modules, the Modicon X80 modules platform may be used in harsh environments or within a range of operating temperatures from -25 to +70 °C / -13 to +158 °F (see page 9/2).

(1) See the compatibility guide on page 1/8.

(2) EcoStruxure Control Expert software continues the Unity Pro range of software and corresponds to versions ≥ 14 of Unity Pro.

(3) Technology Partner Program

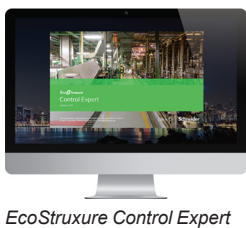
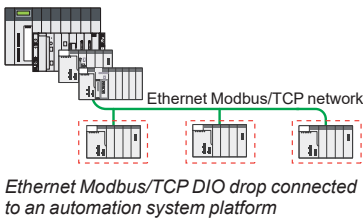
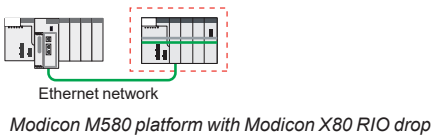
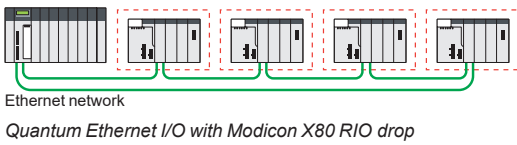

EcoStruxure Control Expert

Architectures based on the Modicon X80 modules platform

Single-rack or multi-rack local I/O configuration with Modicon M580 or M340 processor

This configuration comprises:

- a Modicon X80 primary rack with a Modicon M580 or M340 processor
- a Modicon X80 secondary rack

This configuration may comprise 4 racks with **BMXP342●●●** processors separated by a maximum cumulative distance of 30 m/98 ft. It can comprise up to 7 racks with M580 processors.

Quantum Ethernet I/O with Modicon X80 RIO Drop

This architecture comprises:

- a Quantum Ethernet I/O platform comprising a processor and a CRP Ethernet head adapter
- one or more Modicon X80 RIO drops with a standard or performance BMXCRA drop adapter

This configuration may include:

- 16 drops with **140CPU6●1●●** processors
- 31 drops with **140CPU6●2●●/140CPU6●8●●** processors

Modicon M580 platform with Modicon X80 RIO Drop

This architecture comprises:

- a Modicon M580 automation platform comprising a processor and dedicated modules
- one or more Modicon X80 RIO drops with a standard or performance BMXCRA drop adapter on an X-bus rack or
- one or more Modicon X80 RIO drops with a BMECRA drop adapter on an Ethernet + X-bus rack

Ethernet Modbus/TCP DIO drop connected to an automation system platform

This architecture comprises:

- a Quantum/Premium/M580/M340 automation platform
- one or more Ethernet Modbus/TCP DIO drops with a **BMXPRA0100** peripheral remote I/O adapter, a power supply, and I/O

Software configuration

EcoStruxure Control Expert (1) programming software is required to set up the Modicon X80 modules platform.

The EcoStruxure Control Expert (1) function block software libraries make it possible to meet the needs of specialist applications in various fields of application such as:

- Water and Waste Water (WWW)
- Consumer Packaged Goods (CPG)
- Mining, Minerals, Metals (MMM)
- Oil & Gas (O&G)

(1) Unity Pro software in earlier versions.

Single-rack configuration

- Presentation, description, references [page 2/2](#)
- Accessories for single-rack configuration [page 2/5](#)

Multi-rack configuration

- Presentation, description [page 2/6](#)
- Accessories, references [page 2/9](#)

Presentation

The Modicon X80 modules platform is compatible with two types of backplanes:

- Dual Ethernet and X-bus backplanes
- X-bus backplanes (1).

One Ethernet switch is embedded inside the backplane with connectivity to some slots on the backplane, and not all slots have Ethernet connectivity.

X-bus functionality is preserved and conforms to the legacy implementation and specification. The X-bus will be used in a subset of modules on the Ethernet backplane.

The backplanes provide the power supply for the modules in the rack.

BMXXBP●●00 racks are basic elements in Modicon X80 modules platform single-rack and multi-rack configurations. They assign a rack number to X-bus slots. They also perform the following functions:

- Mechanical function: They are used to install modules in a PLC station (power supply, processor, discrete, analog, and application-specific I/O). These racks can be mounted on a panel or a plate:
 - Inside enclosures
 - On machine frames, etc.
- Electrical function: The racks incorporate X-bus (proprietary bus). They are used to:
 - Distribute the power supplies required for each module in the same rack
 - Distribute data and service signals for the entire PLC station
 - Hot swap modules during operation

BMEXBP●●00 racks provide the following services to X-bus slots:

- Supply a rack number
- Supply the interconnection for the slots in the main and extended backplanes

BMEXBP●●02 are dual power supply racks with two CPS slots for two redundant power supplies. They feature:

- Compatibility only with redundant power supplies
- Security of power supply in high-availability applications

The Ethernet interface is the main communication medium in the Ethernet backplane. The Ethernet modules on the Ethernet backplane are attached to one of several ports. The modules connect to the Ethernet switch chip embedded in the Ethernet backplane.

The Ethernet backplane provides the following services to ETH slots:

- ETH connection to ETH slots
- Point-to-point connection

Description

X-bus backplanes

BMXXBP●●00 racks are available in 4, 6, 8, or 12-slot versions and comprise:

- 1 A metal frame with the following functions:
 - Holds the X-bus electronic card and helps it withstand EMI and ESD type interference
 - Holds the modules
 - Gives the rack mechanical rigidity
- 2 A ground terminal for grounding the rack
- 3 4 holes (big enough for M6 screws) for mounting the rack on a frame
- 4 2 fixing points for the shielding connection bar
- 5 Tapped holes to take the locking screw on each module
- 6 A connector for a rack expansion module, marked **XBE**
- 7 40-way female ½ DIN connectors forming the electrical connection between the rack and each module, marked **CPS, 00...11** (the rack is delivered with each connector protected by a cover, which needs to be removed before inserting the module)
- 8 Slots for anchoring the module pins

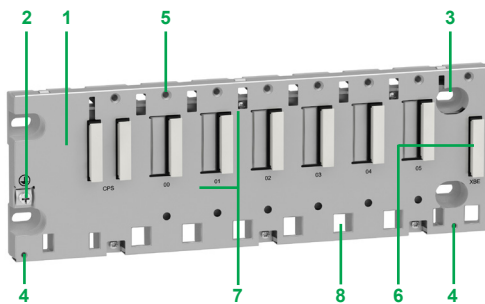

BMXXBP0600 rack with 6 slots

(1) Mandatory PV02 version or later.

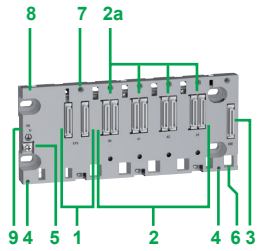

BMEXBP0400 backplane

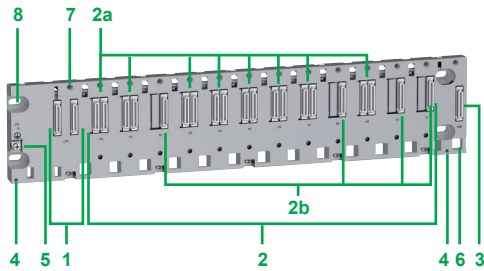

BMEXBP1200 backplane

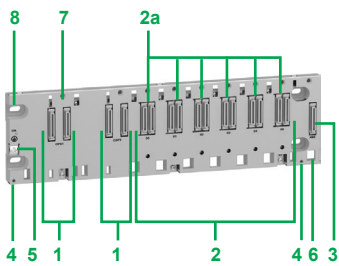

BMEXBP0602 backplane

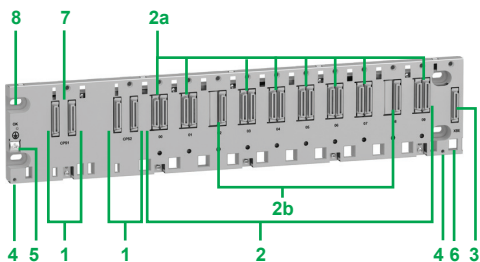

BMEXBP1002 backplane

Description (continued)

Dual Ethernet and X-bus backplanes

The number of X-bus and Ethernet slots found on a backplane depends on the backplane size.

BMEXBP0400/BMEXBP0800 are 4/8-slot dual Ethernet and X-bus backplanes with:

- 1 CPS slot for power supply
- 2 4 slots (**BMEXBP0400**)/8 slots (**BMEXBP0800**) with:
 - 2a 4/8 Ethernet and X-bus connectors for mixed modules
 - 2b Extension: 1 connector for a X-bus backplane expansion
- 3 2 fixing points for the shielding connection bar
- 4 Protective ground screw
- 5 Slots for anchoring the module pin
- 6 Tapped holes for the locking screw on each module
- 7 4 holes for M4, M5, M6, or UNC #6-32 screws (4.32 mm to 6.35 mm/0.17 to 0.25 in.)
- 8 Rack fastened to 35 mm/1.38 in. wide and 15 mm/0.59 in. deep DIN rails. Mounting on a 35 mm/1.38 in. wide and 7.5 mm/0.295 in. deep DIN rail is also possible (in this case, the product withstands less mechanical stress).

BMEXBP1200 is a 12-slot dual Ethernet and X-bus backplane with:

- 1 CPS slot for power supply
- 2 12 slots with:
 - 2a 8 Ethernet and X-bus connectors for mixed modules
 - 2b 4 X-bus connectors for X-bus modules
- 3 Extension: 1 connector for an X-bus backplane expansion
- 4 2 fixing points for the shielding connection bar
- 5 Protective ground screw
- 6 Slots for anchoring the module pin
- 7 Tapped holes for the locking screw on each module
- 8 4 holes for M4, M5, M6, or UNC #6-32 screws (4.32 mm to 6.35 mm/0.17 to 0.25 in.)

Dual power supply backplanes

BMEXBP0602 is a 6-slot dual Ethernet and X-bus backplane with:

- 1 2 CPS slots for **BMXCPS4002** redundant power supply only
- 2 6 slots with:
 - 2a 6 Ethernet and X-bus connectors for mixed modules
 - 2b Extension: 1 connector for an X-bus backplane expansion
- 3 2 fixing points for the shielding connection bar
- 4 Protective ground screw
- 5 Slots for anchoring the module pin
- 6 Tapped holes for the locking screw on each module
- 7 4 holes for M4, M5, M6, or UNC #6-32 screws (4.32 to 6.35 mm/0.17 to 0.25 in.)
- 8 Rack is fastened to 35 mm/1.38 in. wide and 15 mm/0.59 in. deep DIN rails. Mounting on a 35 mm/1.38 in. wide and 7.5 mm/0.295 in. deep DIN rail is also possible (in this case, the product withstands less mechanical stress).

BMEXBP1002 is a 10-slot dual Ethernet and X-bus backplane with:

- 1 2 CPS slots for **BMXCPS4002** redundant power supply only
- 2 10 slots with:
 - 2a 8 Ethernet and X-bus connectors for mixed modules
 - 2b 2 X-bus connectors for X-bus modules
- 3 Extension: 1 connector for an X-bus backplane expansion
- 4 2 fixing points for the shielding connection bar
- 5 Protective ground screw
- 6 Slots for anchoring the module pin
- 7 Tapped holes for the locking screw on each module
- 8 4 holes for M4, M5, M6, or UNC #6-32 screws (4.32 to 6.35 mm/0.17 to 0.25 in.)

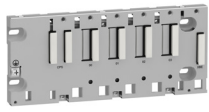

BMXXBP0400

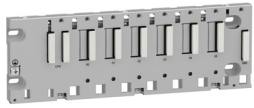

BMXXBP0600

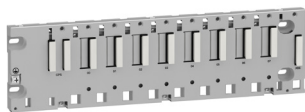

BMXXBP0800

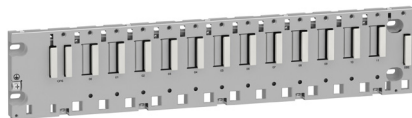

BMXXBP1200

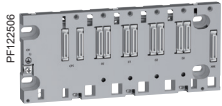

BMEXBP0400

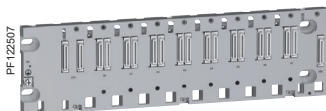

BMEXBP0800

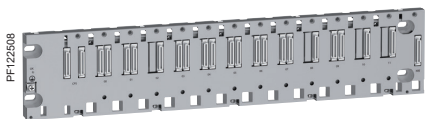

BMEXBP1200

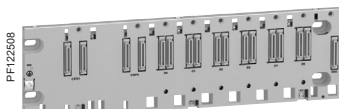

BMEXBP0602

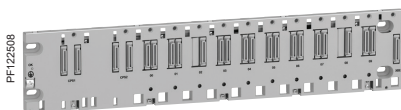

BMEXBP1002

X-bus racks

Description	Type of module to be inserted	No. of slots (1)	Power consumption (2)	Reference	Weight kg/lb
X-bus racks	BMXCPS power supply, BMXP34 or BMEP58 processor, I/O modules, communication modules and application-specific modules (counter, motion control, and serial)	4	1 W	BMXXBP0400	0.630/1.389
		6	1.5 W	BMXXBP0600	0.790/1.742
		8	2 W	BMXXBP0800	0.950/2.094
		12	–	BMXXBP1200	1.270/2.780

Ethernet + X-bus racks (3) (4)

Description (5)	Type of module to be inserted	Ethernet connectors	X-bus connectors	Power consumption (6)	Reference (3)	Weight kg/lb
4-slot Ethernet + X-bus backplane	BMXCPS power supply, BMEP58/BMEH58 processor, I/O modules, communication modules and application-specific modules (counter, motion control, and serial)	4	4	2.8 W	BMEXBP0400	0.719/1.500
8-slot Ethernet + X-bus backplane		8	8	3.9 W	BMEXBP0800	1.064/2.350
12-slot (8 Ethernet + X-bus/4 X-bus) backplane		8	12	3.9 W	BMEXBP1200	1.398/3.080
6-slot Ethernet + X-bus dual power supply backplane	BMXCPS4002 redundant power supply, BMEP58/BMEH58 processor, I/O modules, communication modules and application-specific modules (counter, motion control, and serial)	6	6	3.9 W	BMEXBP0602	1.377/3.036
10-slot (8 Ethernet + X-bus/2 X-bus) dual power supply backplane		8	10	3.9 W	BMEXBP1002	1.377/3.036

(1) Number of slots taking the processor module, I/O modules, communication modules, and application-specific modules (excluding power supply module).

(2) Power consumption of anti-condensation resistor(s).

(3) In an M580 architecture, Ethernet backplanes can be used for RIO drop Ethernet (EIO) but not as expansion racks anywhere. For expansion racks, it is necessary to use BMXXBP0400/0600/0800/1200 racks.

(4) For multi-rack configuration, see page 2/6.

(5) Number of slots for maximum number of modules excluding power supply rack expansion modules.

(6) Power consumption of anti-condensation resistor(s).

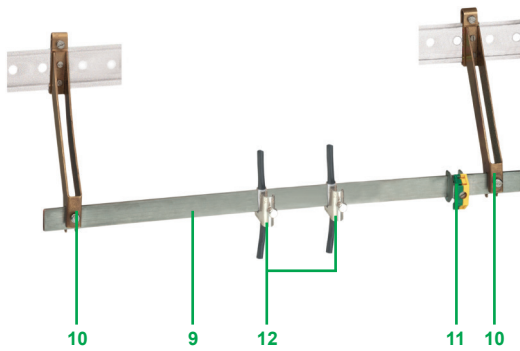

BMXXSP cable shielding connection kit

Description

Dual Ethernet and X-bus backplanes

To be ordered separately:

A **BMXXSP** cable shielding connection kit, used to help protect against electrostatic discharge when connecting the shielding on cordsets for connecting:

- Analog, counter, and motion control modules
- A Magelis XBT operator interface to the processor (via **BMXXCAUSBH** shielded USB cable)

The **BMXXSP** shielding system comprises:

- 9 A metal bar that takes the clamping rings and the grounding terminal
- 10 Two sub-bases to be mounted on the rack
- 11 A grounding terminal (not included)
- 12 Not included in the shielding connection kit, the **STBXSP30** clamping rings (sold in lots of 10, cross-section 1.5...6 mm²/16...10 AWG or 5...11 mm²/10...7 AWG)



Accessories

Description	For use with	Reference	Weight kg/lb
Shielding connection kits comprising: - 1 metal bar - 2 support sub-bases	BMXBP0400 rack	BMXXSP0400	0.280/ 0.617
	BMXXBP0600 rack BMEXBP0602 rack	BMXXSP0600	0.310/ 0.683
	BMXBP0800 rack	BMXXSP0800	0.340/ 0.750
	BMXBP1200 rack BMEXBP1002 rack	BMXXSP1200	0.400/ 0.882
Spring clamping rings Sold in lots of 10	Cables, cross-section 1.5...6 mm ² /16...10 AWG	STBXSP3010	0.050/ 0.110
	Cables, cross-section 5...11 mm ² /10...7 AWG	STBXSP3020	0.070/ 0.154
Protective covers (replacement parts) Sold in lots of 5	Unoccupied slots on BMXXBP rack	BMXXEM010	0.005/ 0.011



STBXSP3000 + STBXSP30

(1) The grounding terminal is not included in the shielding connection kits.

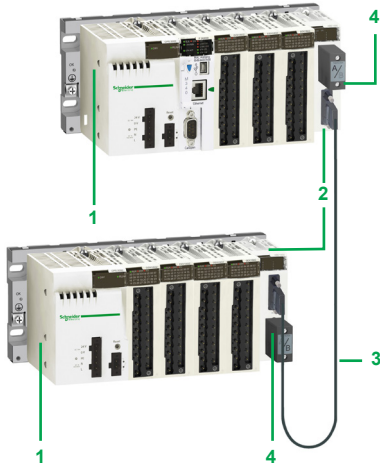

Modicon M340 + expansion rack



Modicon M580 + expansion rack

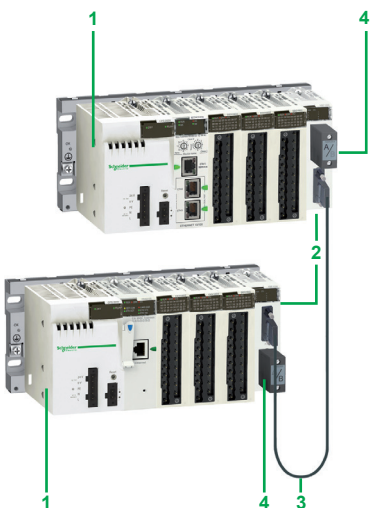

Modicon X80 drop + expansion rack

Composition of a multi-rack configuration

Multi-rack configurations are made up of **BM●XBP●●00** racks (1). They comprise:

- 2 racks maximum for a station with a **BMXP341000** processor
- 4 racks maximum for a station with a **BMXP3420●●●** or **BMXP3420●●●CL** processor
- 4 racks maximum for a station with a **BMEP581020** or **BMEP5820●0** processor
- 8 racks maximum for a station with a **BMEP5830●0**, **BMEP5840●0**, **BMEP585040**, or **BMEP586040** processor

Each rack is equipped with:

- 1 A **BMXCPS●●●●●** power supply or two **BMXCPS4002** redundant power supplies (2)
- 2 A **BMXXBE1000** rack expansion module. This module, inserted in the right-hand end of the rack (**XBE** slot, see page 2/2) does not occupy rack slots **00...11** (4, 6, 8, or 12 slots are still available).
- 3 The **BMXXBE1000** rack expansion modules, which are connected to each other by X-bus cordsets

X-bus

The racks, distributed on the X-bus, are connected to each other by X-bus extension cordsets **3** with a maximum total length of 30 m/98.42 ft.

The racks are connected in a daisy chain using **BMXXBC●●0K** (3) X-bus extension cordsets connected to the two 9-way SUB-D connectors **7** and **8** on the front panels of the **BMXXBE1000** rack expansion modules **2**.

Line terminators 4

Both expansion modules at the ends of the daisy chain must have a line terminator **4 TSXTLYEX** on the unused 9-way SUB-D connector.

Note: The processor module is always positioned in the rack at address 0. However, in an X-bus daisy chain, the order of the racks has no effect on operation. For example, the order of the daisy chain can be 0-1-2-3, 2-0-3-1, or 3-1-2-0, etc.

Composition of an expansion backplane configuration

The Modicon M580 standalone processor supports 4 to 8 local racks (depending on the CPU performance level), using existing X80 I/O modules and accessories. The Modicon M580 CPU can be installed in the first rack (0) and this can be a dual bus rack. The M580 PLC will support up to 7 **BMXXBP●●●●●** PV02 or later backplanes (racks) of 4, 6, 8, or 12 slots. The main backplane (rack 0) will support the CPU.

To extend the configuration using additional racks, users can use a bus extender module (**BMXXBE1000**) and X-bus cables. The backplane extender should be plugged into the dedicated connector on the right side of the backplane. It does not occupy any module slot. The XBE extender module is not hot-swappable, like the rest of the X80 modules platform. Each backplane has to include a power supply module and will support up to 12 modules.

An expansion rack can be connected to the main backplane and the X80 drop (EIO). The rack address is assigned as follows:

- Each rack will be assigned a physical address using 4 microswitches located in the bus extender module.
- The main rack containing the CPU will be assigned address 0.
- The other racks will be assigned addresses 1 to 7.

Each rack is equipped with:

- 1 A **BMXCPS●●●●●** power supply or two **BMXCPS4002** redundant power supplies (2)
- 2 A **BMXXBE1000** rack expansion module. This module, inserted in the right-hand end of the rack (**XBE** slot) does not occupy rack slots 00...11 (4, 6, 8, or 12 slots are still available).
- 3 The **BMXXBE1000** rack expansion modules, which are connected to each other by X-bus cordsets
- 4 Line terminators: Both expansion modules at the ends of the daisy chain must have a line terminator **4 TSXTLYEX** on the unused 9-way SUB-D connector.

(1) **BMEXBP●●●●●** is only supported on M580 processor based platforms.

(2) **BMXCPS4002** redundant power supply is only compatible only with the **BMEXBP0602** and **BMEXBP1002** dual power supply backplane.

(3) **BMXXBC●●0K** extension cordsets, length 0.8 m/2.62 ft, 1.5 m/4.92 ft, 3 m/9.84 ft, 5 m/16.4 ft, or 12 m/39.4 ft, with angled connectors or **TSXCBY●08K** extension cordsets, length 1 m/3.28 ft, 3 m/9.84 ft, 5 m/16.4 ft, 12 m/39.4 ft, 18 m/59 ft, or 28 m/92 ft, with straight connectors.

Ethernet racks

Modicon M580 CPUs support dual bus backplanes (Ethernet and X-bus), as well as Ethernet ring or star architectures on their Ethernet port.

BME●58●●2● CPUs support Ethernet star or ring architectures (RSTP loop is supported on ports 2 and 3). The embedded scanner allows scanning of distributed equipment. The CPU directly drives these devices ("NOC" embedded function).

BME●58●●4● CPUs support an embedded scanner that allows scanning of X80 drops on Ethernet RIO (EIO) and distributed equipment.

Modicon M580 CPUs have an additional third Ethernet port dedicated to the connection of a service tool such as a PC, HMI, or network analyzer. This port is labeled "ETH 1". It does not support RSTP.

Modicon M580 CPUs can communicate on the main Ethernet backplane. They cannot be installed in an expansion rack.

It is necessary to use an Ethernet backplane:

Reference	Description
BMEXBP0400	Standard 4-slot backplane
BMEXBP0800	Standard 8-slot backplane
BMEXBP1200	Standard 12-slot backplane
BMEXBP0602	Dual power supply 6-slot backplane
BMEXBP1002	Dual power supply 10-slot backplane
BMEXBP0400H	Ruggedized 4-slot backplane
BMEXBP0800H	Ruggedized 8-slot backplane
BMEXBP1200H	Ruggedized 12-slot backplane
BMEXBP0602H	Ruggedized dual power supply 6-slot backplane
BMEXBP1002H	Ruggedized dual power supply 10-slot backplane

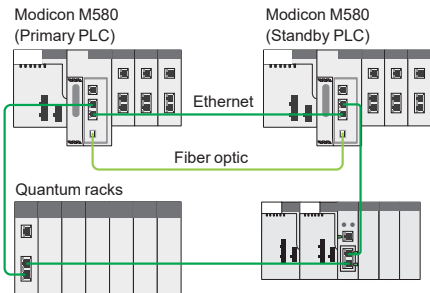

Quantum Ethernet I/O migration

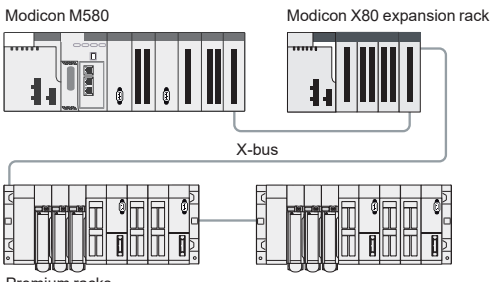

Premium X-bus expansion example



DIA6ED2151012EN

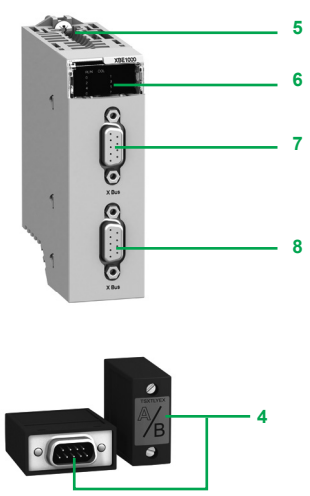

Quantum Ethernet I/O migration

Modicon M580 CPUs levels 4 and above (**BMEP584040**, **BMEP585040**, and **BMEP586040**) support Quantum I/O using the Quantum Ethernet remote drop adapter **140CRA31200**. The number of Remote I/O drops allowed (up to 31) depends on the M580 processor model.

The Quantum Ethernet drop is configured using EcoStruxure Control Expert (1) software. Each Quantum I/O can be configured with the X80 I/O model (Device DDT) or the Quantum model ("State ram" :%I, %IW, %M, %MW) to simplify the reuse of legacy applications.

The compatibilities of Quantum I/O in an Ethernet Quantum drop are identical in a Quantum processor based architecture. See page 1/8 for more information.

In addition, the Modicon LL984 legacy language is supported by some CPU models; please refer to the M580 product catalog for more information.

Premium X-bus extension

The Modicon M580 CPU supports revamping of an existing Premium installation by replacing the Premium rack 0 (CPU and communication modules) with an M580 rack. It is also possible to combine Premium racks **TSXRKY4EX/6EX/8EX/12EX** with X80 I/O based on an X-bus rack. The majority of existing configurations are supported. The number of expanded racks allowed depends on which CPU is being used:

- The **BMEP581020**, **BMEP582020**, and **BMEP582040** CPUs support a main local rack and up to 3 expansion racks. If you are using 4, 6, or 8-slot Premium expansion racks, you can install 2 physical racks at each assigned rack address, allowing up to 6 Premium expansion racks (up to 6 backplanes and 100 m/328 ft between 2 drops).
- The **BMEP583020**, **BMEP583040**, **BMEP584020**, and **BMEP584040** CPUs support a main local rack with up to 7 expansion racks. If you are using 4, 6, or 8-slot Premium expansion racks, you can install 2 physical racks at each assigned rack address, allowing up to 14 Premium expansion racks.

The maximum number of supported X-bus drops is as follows:

- 4 for **BMEP581000/2000**
- 8 for **BMEP583000/4000**

The maximum number of X-bus drops is calculated as follows:

- Max number = 1 for CPU rack (**BMXXBP000** or **BMEXP000**) + ½ the number of **TSXRKY4/6/8EX** racks + the number of **TSXRKY12EX** racks + the number of **BMXXBP000** racks

Description

The front panel of the **BMXXBE1000** rack expansion module comprises:

- 5 A screw for locking the module in its slot (at the far right-hand end of the rack)
- 6 A display block with 5 LEDs:
 - RUN LED (green): Module running
 - COL LED (red): Several racks have the same address, or rack address 0 does not contain the **BMXP34000** or **BMXP58000** processor module
 - LEDs 0, 1, 2, and 3 (green): rack address 0, 1, 2, or 3
- 7 A 9-way female SUB-D connector, marked X-bus, for the incoming X-bus cordset **3** connected to the upstream rack, or if it is the first rack, for the **A/** line terminator included in the **TSXTLYEX 4** pack
- 8 A 9-way female SUB-D connector, marked X-bus, for the outgoing X-bus cordset **3** to the downstream rack, or if it is the last rack, for the **B/** line terminator included in the **TSXTLYEX 4** pack

On the right-hand side panel

A flap for accessing the 3 rack addressing microswitches: 0...3

Installation rules for **BM0XBP000** racks

Rules for installing racks in enclosures (see our website www.se.com).

(1) EcoStruxure Control Expert software continues the Unity Pro range of software and corresponds to versions ≥ 14 of Unity Pro.



BMXXBE1000

Rack expansion			
Description	Use	Reference	Weight kg/lb
Modicon X80 I/O rack expansion module	Standard module for mounting in each rack (XBE slot) and used to interconnect: - Up to 2 racks with BMXP341000 processor module - Up to 4 racks with BMXP342000 processor module - Up to 3 racks with BMEP581020/20000 processor module - Up to 7 racks with BMEP583000/4000/5000/6000 processor module - 1 rack with X80 drop (EIO)	BMXXBE1000	0.178/ 0.392
Modicon X80 I/O rack expansion kit	Complete kit for 2-rack configuration comprising: - 2 BMXXBE1000 rack expansion modules - 1 BMXXBC008K extension cordset, length 0.8 m/2.62 ft - 1 TSXTLYEX line terminator (set of 2)	BMXXBE2005	0.700/ 1.543



BMXXBC008K

Cordsets and connection accessories										
Description	Use	Composition	Type of connector	Length m/ft	Reference	Weight kg/lb				
X-bus expansion cordsets total length 30 m/98 ft max (1).	Between 2 BMXXBE1000 rack expansion modules	2 x 9-way SUB-D connectors	Angled	0.8/	BMXXBC008K	0.165/				
				2.62		0.363				
				1.5/	BMXXBC015K	0.250/				
				4.92		0.551				
				3/	BMXXBC030K	0.420/				
				9.84		0.926				
				5/	BMXXBC050K	0.650/				
				16.4		1.433				
				12/	BMXXBC120K	1.440/				
				39.4		3.175				
				Straight				1/	TSXCBY010K	0.160/
								3.28		0.353
3/	TSXCBY030K	0.260/								
39.4		0.573								
5/	TSXCBY050K	0.360/								
16.4		0.794								
12/	TSXCBY120K	1.260/								
39.4		2.778								
18/	TSXCBY180K	1.860/								
59		4.101								
28/	TSXCBY280KT	2.860/								
92	(2)(3)	6.305								

Cable reel (1)	Length of cable to be equipped with TSXCBYK9 connectors	Cable with ends with flying leads, 2 line testers	–	100/ 328	TSXCBY1000	12.320/ 27.161
-----------------------	---	---	---	-------------	----------------------------	-------------------



TSXTLYEX

Description	Use	Composition	Sold in lots of	Reference	Weight kg/lb
Line terminators	Required on both BMXXBP0000 modules located at either end of the daisy chain	2 x 9-way SUB-D connectors marked A/ and /B	2	TSXTLYEX	0.050/ 0.110
X-bus straight connectors	For TSXCBY1000 cables	2 x 9-way SUB-D straight connectors	2	TSXCBYK9	0.080/ 0.176
Connector assembly kit	For fixing TSXCBYK9 connectors	2 crimping pliers, 1 pen (3)	–	TSXCBYACC10	–

(1) Module and cordsets do not operate properly at temperatures lower than -25 °C/-13 °F.
 (2) Cable supplied with a set of 2 TSXTVSY100 electrical transient suppressors.
 (3) To fix the connectors to the cable, you also need a wire stripper, a pair of scissors, and a digital ohmmeter.

X80 power supplies

- Presentation, description [page 3/2](#)
- Functions, references [page 3/3](#)

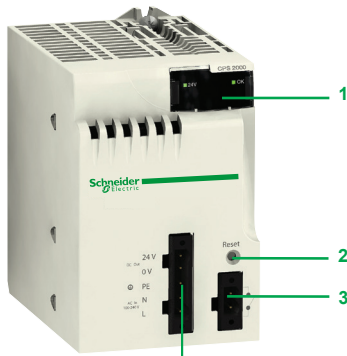

BMXCPS2000

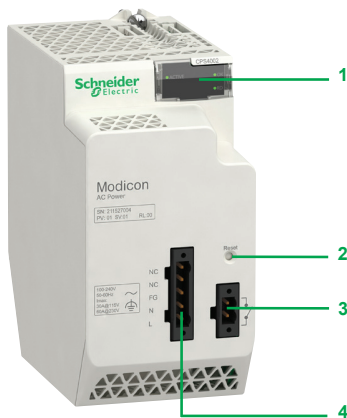

BMXCPS4002

Presentation

BMXCPS●●●● power supplies provide the power supply for each **BMEXBP●●00** or **BMXXBP●●00** Modicon X80 rack and the modules installed on it (**BMEXBP●●02** supports **BMXCPS●●●●2** modules only).

The Modicon X80 power supplies offer comprises:

- Five power supplies for DC line supplies:
 - 24 V $\overline{\text{---}}$, 17 W isolated power supply module, **BMXCPS2010**
 - 24...48 V $\overline{\text{---}}$, 32 W isolated power supply module, **BMXCPS3020**
 - 24...48 V $\overline{\text{---}}$, 40 W redundant power supply module, **BMXCPS4022**
 - 125 V $\overline{\text{---}}$, 36 W power supply module, **BMXCPS3540T** (extended operating temperature -25 to +70 °C/-13 to +158 °F)
 - 125 V $\overline{\text{---}}$, 40 W redundant power supply module, **BMXCPS3522**
- Three power supplies for AC line supplies:
 - 100...240 V \sim , 20 W power supply module, **BMXCPS2000**
 - 100...240 V \sim , 36 W power supply module, **BMXCPS3500**
 - 100...240 V \sim , 40 W redundant power supply module, **BMXCPS4002**

Description

The power supply is selected according to:

- The electrical line supply: 24 V $\overline{\text{---}}$, 48 V $\overline{\text{---}}$, 125 V $\overline{\text{---}}$, or 100...240 V \sim
- The required power (see the power consumption table available on our website www.se.com) (1)

BMXCPS●●●● power supplies have the following on the front panel:

- 1 A display block comprising:
 - OK LED (green), lit if rack voltages are present and correct
 - 24 V LED (green), lit when the sensor voltage is present (BMXCPS2000/3500/3540T power supply modules only)
 - RD LED (green), lit when all the internal power supply modules are functioning normally (BMXCPS4002/BMXCPS4022/BMXCPS3522 redundant power supply modules only)
 - ACT LED (green), lit when the power supply is the Master power supply, off when it acts as a slave supply in redundant application (BMXCPS4002/BMXCPS4022/BMXCPS3522 redundant power supply modules only)
- 2 A pencil-point RESET pushbutton for a cold restart of the application
- 3 A 2-way connector that can take a removable terminal block (caged or spring-type) for connecting the alarm relay
- 4 A 5-way connector that can take a removable terminal block (caged or spring-type) for connecting the following:
 - $\overline{\text{---}}$ or \sim line supply
 - Protective ground
 - Dedicated 24 V $\overline{\text{---}}$ power supply for the input sensors (for BMXCPS2000/3500/3540T power supply modules only)

Included with each power supply module:

- Set of two **BMXXTSCPS10** caged removable terminal blocks (5-way and 2-way)

To be ordered separately (if necessary):

- Set of two **BMXXTSCPS20** spring-type removable terminal blocks (5-way and 2-way)

Compatibility of the power supply with the rack

The redundant AC power supply can be used alone in a single power supply rack or as a pair in a dual power supply rack. For high-availability applications, two independent redundant power supplies can be used to increase the security of power supply. In case the master power supply fails to provide the total current, the slave power supply will change to master mode and continue to function.

Type	Standalone power supply (BMXCPS●●●0)	Redundant power supply (BMXCPS●●●2)
Single power supply racks (BMXXBP●●00, BMEXBP●●00)		
Dual power supply racks (BMEXBP●●02)		
<div style="background-color: #008000; width: 15px; height: 10px; display: inline-block;"></div> Compatible		
<div style="background-color: #cccccc; width: 15px; height: 10px; display: inline-block;"></div> Incompatible		

(1) This power consumption calculation for the rack can also be performed by EcoStruxure Control Expert V14 (Unity Pro in earlier versions) programming software.



BMXCPS2010/3020



BMXCPS2000/3500



BMXCPS4002



BMXCPS4022



BMXCPS3522

Functions

Alarm relay

The alarm relay incorporated in each power supply module has a volt-free contact accessible on the front panel, on the 2-way connector.

The operating principle is as follows:

In normal operation, with the PLC in RUN, the alarm relay is energized and its contact is closed (state 1).

The relay de-energizes and its associated contact opens (state 0) whenever the application stops, even partially, due to any of the following:

- Detection of a blocking fault
- Incorrect rack output voltages
- Loss of supply voltage

RESET pushbutton

The power supply module in each rack has a RESET button on the front panel which, when pressed, triggers an initialization sequence on the processor and the modules in the rack it supplies.

Pressing this pushbutton triggers a sequence of service signals, which is the same as that for:

- A power break, when the pushbutton is pressed
- A power-up, when the pushbutton is released
- In terms of the application, these operations represent a cold start (forcing the I/O modules to state 0 and initializing the processor).

Sensor power supply

BMXCPS2000/3500 AC power supplies and **BMXCPS3540T** DC power supplies have an integrated 24 V $\bar{\text{---}}$ supply for powering the input sensors.

Connection to this 24 V $\bar{\text{---}}$ sensor power supply is via the 5-way connector on the front panel. The available power depends on the power supply (0.45 A or 0.9 A).

References

Each **BMEXBP●●00** or **BMXXBP●●00** rack must be equipped with a power supply. **BMEXBP●●02** must be equipped with 1 or 2 redundant power supplies. These power supplies are inserted in the leftmost power supply slots of each rack (marked CPS).

The power required to supply each rack depends on the type and number of modules installed in the rack. It is therefore necessary to draw up a power consumption table for each rack in order to determine which

BMXCPS●●●● power supply is the most suitable for each rack (please consult our website www.se.com).

X80 Power supplies (1)

Line supply	Available power (2)			Total	Nominal current 24 V $\bar{\text{---}}$ rack (3)	Reference	Weight kg/lb
	3.3 V $\bar{\text{---}}$ (3)	24 V $\bar{\text{---}}$ rack (3)	24 V $\bar{\text{---}}$ sensors (4)				
24 V $\bar{\text{---}}$ isolated	8.3 W	17 W	–	17 W	0.7 A	BMXCPS2010	0.290/ 0.639
24...48 V $\bar{\text{---}}$ isolated	15 W	32 W	–	32 W	1.3 A	BMXCPS3020	0.340/ 0.750
24...48 V $\bar{\text{---}}$	18 W	40 W	–	40 W	1.67 A	BMXCPS4022	0.810/ 1.786
100...150 V $\bar{\text{---}}$	15 W	31.2 W	21.6 W	36 W (5)	1.3 A	BMXCPS3540T (5)	0.340/ 0.750
	180 W	40 W	–	40 W	1.67 A	BMXCPS3522	0.610/ 1.345
100...240 V \sim	8.3 W	16.8 W	10.8 W	20 W	0.7 A	BMXCPS2000	0.300/ 0.661
	15 W	31.2 W	21.6 W	36 W	1.3 A	BMXCPS3500	0.360/ 0.794
	18 W	40 W	–	40 W	1.67 A	BMXCPS4002	0.360/ 0.794

Separate parts

Description	Type	Composition	Reference	Weight kg/lb
Set of 2 removable connectors	Spring-type	One 5-way terminal block and one 2-way terminal block	BMXXTSCPS20	0.015/ 0.033
	Caged	One 5-way terminal block and one 2-way terminal block	BMXXTSCPS10	0.020/ 0.044

(1) Include a set of 2 caged removable connectors. Spring-type connectors available separately under reference [BMXXTSCPS20](#).

(2) The sum of the power consumed on each voltage (3.3 V $\bar{\text{---}}$ and 24 V $\bar{\text{---}}$) must not exceed the total power of the module. See the power consumption table available on our website www.se.com.

(3) 3.3 V $\bar{\text{---}}$ and 24 V $\bar{\text{---}}$ rack voltages for powering modules in the Modicon X80 I/O rack.

(4) 24 V $\bar{\text{---}}$ sensor voltage for powering the input sensors (voltage available via the 2-way removable connector on the front panel).

(5) Extended operating temperature -25 to +70 °C/-13 to +158 °F (with power derating at extreme temperatures: 27 W between -25 and 0 °C/-13 and 0 °F and between 60 and 70 °C/140 and 158 °F).

X80 Discrete I/O modules

- [Selection guide](#) page 4/2
- [Presentation, description](#) page 4/8
- [Connections](#) page 4/9
- [Functions, characteristics](#) page 4/10
- [References](#) page 4/11

X80 Analog I/O modules

- [Selection guide](#) page 4/14
- [Presentation](#) page 4/18
- [Description](#) page 4/19
- [Connections, combinations](#) page 4/20
- [Complementary characteristics](#) page 4/21
- [References](#) page 4/22

X80 HART analog I/O modules

- [Selection guide](#) page 4/24
- [Presentation, description](#) page 4/26
- [References](#) page 4/27

X80 Inputs and OsiSense sensors compatibility

- [X80 Inputs and OsiSense XU compatibility table](#) page 4/28
- [X80 Inputs and OsiSense XS compatibility table](#) page 4/30



Modicon X80 modules platform

X80 I/O modules
Discrete input modules

Applications

8-channel input modules	16-channel input modules
Connection via 20-way caged, screw clamp, or spring-type removable terminal block	



Type	~	~	---	
Voltage	200...240 V	100...120 V	24 V	48 V
Current per channel	10.4 mA (for U = 220 V to 50 Hz)	5 mA	3.5 mA	2.5 mA
Modularity (Number of channels and commons)	8 isolated inputs and 1 common	8 isolated channels and no common point	16 isolated inputs and 1 common	
Connection	Via BMXFTB20●0 20-way caged, screw clamp, or spring-type removable terminal block			
Isolated inputs	IEC/EN 61131-2 conformity			
Logic	Type 2	Type 3	Type 3	Type 1
Type of input	Capacitive	Capacitive	Current sink	
Sensor compatibility IEC/EN 60947-5-2	2-wire ~	2-wire ~	2-wire ---, 3-wire --- PNP any type	
Sensor power supply (ripple included)	170...264 V	85...132 V (no sensor power monitoring)	19...30 V	38...60 V
Protection of inputs	Use one 0.5 A fast-blow fuse per group of channels	Use one 0.25 A fast-blow fuse per channel	Use one 0.5 A fast-blow fuse per group of channels	
Maximum dissipated power	4.73 W	2.35 W	2.5 W	3.6 W
Operating temperature	0...60 °C/32...140 °F			
Compatibility with TeSys Quickfit installation system	-			
Compatibility with Modicon Telefast ABE7 pre-wired system	Passive connection sub-bases Adapter sub-bases with relays			
References	BMXDAI0805	BMXDAI0814	BMXDDI1602	BMXDDI1603
Pages	4/11			

16-channel input modules	Connection via 40-way caged or spring-type removable terminal block	Connection via 20-way caged, screw clamp, or spring-type removable terminal block
Connection via 20-way caged, screw clamp, or spring-type removable terminal block		



Type	~ or ---	~	---				
Voltage	24 V (~ or ---)	48 V	100...120 V	100...120 V ~	200...240 V ~	125 V	
Current per channel	3 mA (~ or ---)	5 mA		10.1 mA (max) at 50 Hz 11.9 mA (max) at 60 Hz	9.7 mA (max) at 50 Hz 11.5 mA (max) at 60 Hz	2.4 mA	
Modularity (Number of channels and commons)	16 isolated inputs and 1 common		16 isolated inputs		16 isolated inputs and 1 common		
Connection	Via BMXFTB20●0 20-way caged, screw clamp, or spring-type removable terminal block		Via BMXFTB40●0 40-way caged or spring-type removable terminal block		Via BMXFTB20●0 20-way caged, screw clamp, or spring-type removable terminal block		
Isolated inputs	IEC/EN 61131-2 conformity						
Logic	Type 1 (~)	Type 3	Type 1	Non-type at 50 Hz Type 1 at 60 Hz	Type 1	-	
Type of input	Negative (source) (---)	-	Positive (sink)			Current sink	
Sensor compatibility IEC/EN 60947-5-2	Resistive	Capacitive	Current sink				
Sensor power supply (ripple included)	2-wire ---/~, 3-wire --- PNP or NPN any type	2-wire ~	2-wire		-		
Protection of inputs	19...30 V --- 20...26 V ~	40...52 V	85...132 V	100...120 V ~	200...240 V ~	88...150 V	
Maximum dissipated power	Use one 0.5 A fast-blow fuse per group of channels		Use one 0.25 A fast-blow fuse per channel		Use one 0.5 A fast-blow fuse per group of channels		
Operating temperature	3 W	4 W	3.8 W	4.3 W	8.5 W (at 40 °C/104 °F)		
Compatibility with TeSys Quickfit installation system	0...60 °C/32...140 °F						
Compatibility with Modicon Telefast ABE7 pre-wired system	-						
References	BMXDAI1602	BMXDAI1603	BMXDAI1604	BMXDAI1614	BMXDAI16142	BMXDAI1615	BMXDDI1604T
Pages	4/11						

4

4

Modicon X80 modules platform

X80 I/O modules
Discrete input and mixed I/O modules

Applications	32-channel high-density input modules Connection via 40-way connectors with preassembled cordsets	32-channel input modules Connection via 40-way caged or spring-type removable terminal block	
--------------	--	---	--



Type	---		---
Voltage	24 V		48 V
Current per channel	Inputs	2.5 mA	3.3 mA
	Outputs	2.3 mA	
Modularity (Number of channels and commons)	32 isolated inputs and 2 commons		
Connection	Via one 40-way connector	Via BMXFTB40●0 40-way caged or spring-type removable terminal block	
Isolated inputs	IEC/EN 61131-2 conformity	Type 1	Type 3
	Logic	Positive (sink)	Positive (sink) / Negative (source)
	Type of input	Current sink	Current sink/source
Sensor power supply (ripple included)	19...30 V	38...60V	
Protection of inputs	Use one 0.5 A fast-blow fuse per group of channels		
Isolated outputs	Fallback	-	
	IEC/EN 61131-2 conformity	-	
	Protection	-	
Pre-actuator power supply (ripple included)	-		
Output fuse protection	-		
Maximum dissipated power	3.9 W	4.7 W	6 W
Operating temperature	0...60 °C/32...140 °F		
Compatibility with TeSys Quickfit installation system	LU9 G02 splitter boxes (8 motor starters) and BMXFCC●1/●3 preassembled cordsets (see pages 4/9 and 4/13)	-	
Compatibility with Modicon Telefast ABE7 pre-wired system (1)	Passive connection sub-bases	Depending on model, 8- or 16-channel passive sub-bases, with or without LED, with common or 2 terminals per channel	
	Adapter sub-bases with relays	Depending on model, active sub-bases with solid state or electromagnetic relays (fixed or removable), 16 channels, with common or 2 terminals per channel (screw clamp or spring-type connection)	
References	BMXDDI3202K	BMXDDI3232	BMXDDI3203
Pages	4/12	9/6	

(1) For more information, please refer to the "Telefast Pre-wired system – Modicon ABE7 IP20 connection sub-bases" catalog or visit our website www.se.com.

64-channel high-density input modules Connection via 40-way connectors with preassembled cordsets	16- or 32-channel mixed I/O modules Connection via 20-way caged, screw clamp, or spring-type removable terminal block	Connection via 40-way connector with preassembled cordsets	
--	--	--	--



Type	---	---	--- and ~ (outputs only)	---
Voltage	24 V	Inputs: 24 V Solid-state outputs: 24 V	Inputs: 24 V --- Relay outputs: 24 V --- or 24...240 V ~	Inputs: 24 V Solid-state outputs: 24 V
Current per channel	1 mA	3.5 mA	3.5 mA	2.5 mA
	-	0.5 A	2 A (--- or ~)	0.1 A
Modularity (Number of channels and commons)	64 isolated inputs and 4 commons	8 isolated inputs and 1 common, 8 isolated outputs and 1 common		16 isolated inputs and 1 common, 16 isolated outputs and 1 common
Connection	Via two 40-way connectors	Via BMXFTB20●0 20-way caged, screw clamp, or spring-type removable terminal block		Via one 40-way connector
Isolated inputs	Non-type	Type 3		Type 1
	Positive (sink)	-		Positive (sink)
	Current sink	2-wire ---, 3-wire --- PNP any type		
Sensor power supply (ripple included)	19...30 V	19...30 V		
Protection of inputs	Use one 0.5 A fast-blow fuse per group of channels	Use one 0.5 A fast-blow fuse per group of channels		
Isolated outputs	Fallback	Configurable output fallback, continuous monitoring of output control, and resetting of outputs in case of internal detected fault		
	IEC/EN 61131-2 conformity	Yes		
	Protection	Protected	Not protected	Protected
Pre-actuator power supply (ripple included)	Positive		-	Positive
Output fuse protection	19...30 V	19...30 V --- 24...240 V ~		19...30 V
Maximum dissipated power	-	Use a 2 A fast-blow fuse	Use a 12 A fast-blow fuse	Use a 2 A fast-blow fuse
Operating temperature	4.3 W	3.7 W	3.1 W	4 W
Compatibility with TeSys Quickfit installation system	0...60 °C/32...140 °F	0...60 °C/32...140 °F		
Compatibility with Modicon Telefast ABE7 pre-wired system (1)	LU9 G02 splitter boxes (8 motor starters) and BMXFCC●1/●3 preassembled cordsets (see pages 4/9 and 4/13)	-		LU9 G02 splitter boxes (8 motor starters) and BMXFCC●1/●3 preassembled cordsets (see pages 4/9 and 4/13)
	Depending on model, 8- or 16-channel passive sub-bases, with or without LED, with common or 2 terminals per channel	-		Depending on model, 8- or 16-channel passive sub-bases, with or without LED, with common or 2 terminals per channel
	Depending on model, active sub-bases with solid state or electromagnetic relays (fixed or removable), 16 channels, with common or 2 terminals per channel (screw clamp or spring-type connection)	-		Depending on model, active sub-bases with solid state or electromagnetic relays (fixed or removable), 16 channels, with common or 2 terminals per channel (screw clamp or spring-type connection)
References	BMXDDI6402K	BMXDDM16022	BMXDDM16025	BMXDDM3202K
Pages	4/12			

(1) For more information, please refer to the "Telefast Pre-wired system – Modicon ABE7 IP20 connection sub-bases" catalog or visit our website www.se.com.

Modicon X80 modules platform

X80 I/O modules Discrete output modules

Applications

32- or 64-channel high-density output modules Connection via 40-way connectors with preassembled cordsets



Type	☐ transistor	
Voltage	24 V	
Current per channel	0.1 A	
Modularity (Number of channels and commons)	32 protected outputs and 2 commons	64 protected outputs and 4 commons
Connection	Via one 40-way connector	Via two 40-way connectors
Outputs	Configurable output fallback, continuous monitoring of output control, and resetting of outputs in case of internal detected fault	
Fallback	Yes	
IEC/EN 61131-2 conformity	Yes	
Protection	Positive	
Logic	Positive	
Preactuator power supply (ripple included)	19...30 V ☐	
Output fuse protection	Use one 2 A fast-blow fuse per group of channels	
Maximum dissipated power	3.6 W	6.85 W
Operating temperature	0...60 °C/32...140 °F	
Compatibility with TeSys Quickfit installation system	LU9 G02 splitter boxes (8 motor starters) and BMXFCC●●1/●●3 preassembled cordsets (see pages 4/9 and 4/13)	
Compatibility with Modicon Telefast ABE7 pre-wired system (1)	Passive connection sub-bases	Depending on model, passive sub-bases with 8- or 16 channels, with or without LED, with common or with 2 terminals per channel
	Adapter sub-bases with relays	Depending on model, active sub-bases with solid state or electromagnetic relays (fixed or removable). 16 channels with 1 common or 2 terminals per channel, screw clamp or spring-type connection
References	BMXDDO3202K	BMXDDO6402K
Pages	4/12	

(1) For more information, please refer to the "Telefast Pre-wired system -- Modicon ABE7 IP20 connection sub-bases" catalog or visit our website www.se.com.

8- or 16-channel output modules Connection via caged, screw clamp, or spring-type removable terminal block



☐ transistor	~ triac	☐ relay	☐/~ relay				
24 V	100...240 V	24...240 V	100...150 V	24 V ☐, 24...240 V ~	24...240 V ~/ 24...125 V ☐	24 V ☐, 24...240 V ~	24...240 V ~/ 24...125 V ☐
0.5 A	0.6 A	3 A	0.3 A (lth)	2 A (lth)	2 A (lth)	2 A (lth)	2 A (lth)
16 protected outputs and 1 common	16 non-protected outputs and 4 commons	16 isolated outputs	8 non-protected outputs, without common	8 normally open isolated relay outputs	16 non-protected outputs and 2 commons	8 normally open/ normally closed isolated relay outputs	
Via BMXF2B20●0 20-way caged, screw clamp, or spring-type removable terminal block		Via BMXF2B40●0 40-way caged or spring-type removable terminal block	Via BMXF2B20●0 20-way caged, screw clamp, or spring-type removable terminal block		Via BMXF2B40●0 40-way caged or spring-type removable terminal block		
Configurable output fallback, continuous monitoring of output control, and resetting of outputs in case of internal detected fault		Configurable output fallback					
Yes		-					
Positive (source)	Negative (sink)	-					
19...30 V		100...240 V	24...240 V	100...150 V	19...30 V ☐, 24...240 V ~	19...264 V ~/ 5...150 V ☐	19...30 V ☐, 24...240 V ~
Use one 6.3 A fast-blow fuse per group of channels		Use one 3 A fast-blow fuse per group of channels	Use one 4 A fast-blow fuse per channel or per group of channels	Use one 0.5 A, 250 V DC fast-blow fuse on each relay	Use one 3 A fast-blow fuse on each channel	Use one fast-blow fuse for each output channel	Use one 12 A fast-blow fuse on each group of channels
4 W	2.26 W	-		3.17 W	2.7 W	3.6 W	3 W
0...60 °C/32...140 °F				-25...70 °C/ -13...158 °F		0...60 °C/32...140 °F	
-							
-							
-							
BMXDDO1602	BMXDDO1612	BMXDAO1605	BMXDAO1615	BMXDRA0804T	BMXDRA0805	BMXDRA0815	BMXDRA1605
4/12							

Presentation

Discrete I/O modules in the Modicon X80 offer are standard modules occupying a single slot on the rack. These modules are equipped with either of the following:

- A connector for a screw clamp or spring-type 20-way removable terminal block
- One or two 40-way connectors

This wide range of discrete I/O can be used to meet whatever requirements arise in terms of:

- Functions: AC or DC I/O, positive or negative logic
- Modularity: 8, 16, 32, or 64 channels per module

The inputs receive signals from the sensors and perform the following functions:

- Acquisition
- Adaptation
- Electrical isolation
- Filtering
- Protection against interference signals

The outputs memorize commands issued by the processor to enable control of the preactuators via the decoupling and amplification circuits.

Description

BMXD●/D●O/DRA discrete I/O modules are standard format (1 slot). They have an IP20 case to help protect the electronics, and are locked into position with a captive screw.

I/O modules connected via 20-way removable terminal block

- 1 Rigid body providing support and protection for the electronic card
- 2 Module reference marking (a label is also visible on the right-hand side of the module)
- 3 Channel status display block
- 4 Connector taking the 20-way removable terminal block for connection of sensors or preactuators

To be ordered separately:

- 5 **BMXFTB20●0** 20-way removable terminal block (identification label supplied with each I/O module) or a preassembled cordset with a 20-way removable terminal block at one end and flying leads at the other (see [page 4/13](#)).

I/O modules connected via 40-way connector(s)

- 1 Rigid body providing support and protection for the electronic card
- 2 Module reference marking (a label is also visible on the right-hand side of the module)
- 3 Channel status display block
- 4 One or two 40-way connectors (32 or 64 channels) (1) for connection of sensors or preactuators
- 5 With the 64-channel module, a pushbutton which, with successive presses, displays the state of channels 0...31 or 32...63 on the display block 3 (see [page 4/10](#))

To be ordered separately, depending on the type of module:

One or two preassembled cordset(s) with a 40-way connector (see [page 4/13](#))

(1) Fujitsu FCN 40-way connector

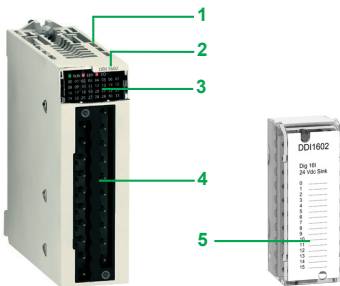

Module for connection via 20-way removable terminal block

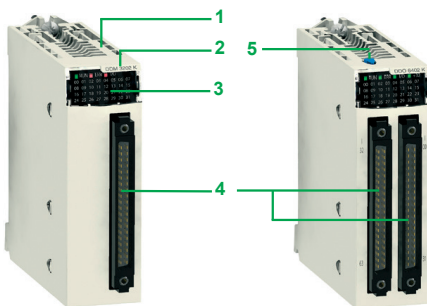

32- and 64-channel modules for connection via one or two 40-way connector(s)



DIA3ED2160602EN



A Preassembled cordset with 20-way removable terminal block at one end and flying leads at the other

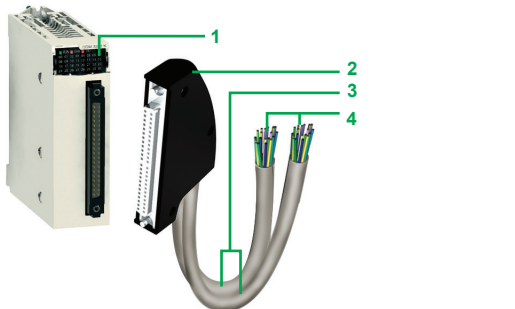

B Preassembled cordset with 40-way connector and two ends with flying leads

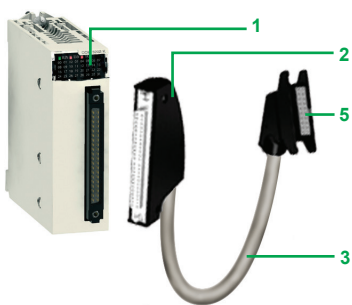

C Preassembled cordset with 40-way connectors and HE10 connectors for Modicon Telefast ABE7 system

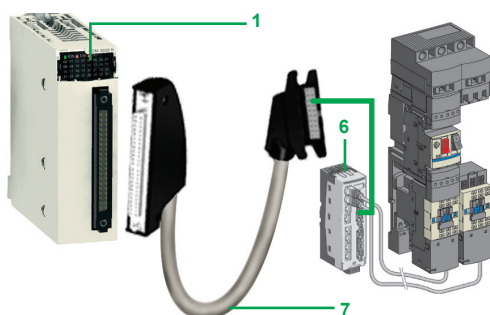

D Example of connection to the TeSys Quickfit installation system

Connecting modules with removable terminal blocks

There are three types of 20-way removable terminal block:

- Screw clamp terminal block
- Caged terminal block
- Spring-type terminal block

Each removable terminal block can take:

- Bare wires
- Wires equipped with **DZ5CE** cable ends

A: One version of the removable terminal block is equipped with 3, 5, or 10 m / 4.92, 9.84, or 16.4 ft cordsets with color-coded flying leads (**BMXFTW●●1**). Use limited to voltages of ≤ 48 V.

Caged terminal blocks

The capacity of each terminal is:

- Minimum: One 0.34 mm² wire (AWG 22)
- Maximum: One 1 mm² wire (AWG 18)

BMXFTB2000 caged connectors are equipped with captive screws (maximum tightening torque 0.5 N.m/0.37 lb-ft).

Screw clamp terminal blocks

The capacity of each terminal is:

- Minimum: One or two 0.34 mm² wires (AWG 22)
- Maximum: Two 1.5 mm² wires (AWG 15)

BMXFTB2010 screw clamp connectors are equipped with captive screws (maximum tightening torque 0.5 N.m/0.37 lb-ft).

Spring terminals

The capacity of each terminal in the **BMXFTB2020** spring-type terminal blocks is:

- Minimum: One 0.34 mm² wire (AWG 22)
- Maximum: One 1 mm² wire (AWG 18)

Connecting modules with 40-way connectors

Preassembled cordsets with 40-way connector at one end and flying leads at the other

B: Preassembled cordsets can be used for easy direct wire-to-wire connection between the I/O of modules with 40-way connectors **1** and the sensors, preactuators, or intermediate terminal blocks.

These preassembled cordsets comprise:

- At one end, a 40-way connector **2** with either of the following:
 - One sheath containing 20 wires with a cross-section of 0.34 mm² (AWG 22) (**BMXFCW●●1**)
 - Two sheaths **3**, each containing 20 wires with a cross-section of 0.34 mm² (AWG 22) (**BMXFCW●●3**)
- At the other end, color-coded flying leads **4** conforming to standard DIN47100

Preassembled cordsets with 40-way connector and HE 10 connector(s)

C: Two types of cordset can be used for connecting the I/O of modules **1** with 40-way connectors to Modicon Telefast ABE7 rapid wiring connection and adaptation interfaces (1).

These preassembled cordsets comprise:

- At one end, a 40-way connector **2** with either of the following:
 - One sheath containing 20 wires (**BMXFC●●1**)
 - Two sheaths **3** each containing 20 wires (**BMXFC●●3**)
- At the other end, one or two HE 10 connectors **5**

Connection to TeSys Quickfit system

D: **1** **BMXDDI3202K/6402K** input modules, **BMXDDO3202K/6402K** output modules, and **BMXDDM3202K** mixed I/O modules with 40-way connectors are designed, amongst other things, for use in conjunction with the TeSys Quickfit mounting system via the **LU9G02** splitter module **6** (for 8 motor starters).

The splitter modules are easily connected using **7** **BMXFC●●1/●●3** preassembled cordsets.

(1) For more information, please refer to the "Telefast Pre-wired system -- Modicon ABE7 IP20 connection sub-bases" catalog or visit our website www.se.com.

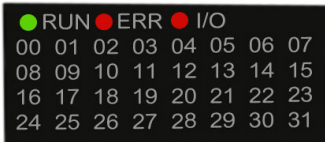

Display block for module BMXDDO6402K

Functions (1)

The discrete I/O modules provide the following functions:

- **Hot swapping:** Due to their special integrated devices, I/O modules (including application-specific modules) can be removed or added while the power is on.
- **I/O assignment:** The channels of discrete I/O modules are grouped into blocks of 4, 8, or 16 consecutive channels depending on the type of module. Each group of channels can be assigned to a specific application task, namely master or fast.
- **Protection of DC inputs:** The 24 V $\overline{\text{DC}}$ and 48 V $\overline{\text{DC}}$ inputs are constant-current type. This characteristic limits the current consumed at the inputs.
- **Protection of DC outputs:** Active transistor outputs can withstand overloads, short-circuits, reverse polarity, and inductive over-voltage.
- **Reactivation of DC outputs:** If a line fault has caused an output to trip, the output can be reactivated using this parameter if no other terminal line fault is present. Reactivation is controlled by means of a group of 8 channels. It can be programmed or automatic.
- **RUN/STOP command:** An input can be configured to control the RUN/STOP changeover for the PLC.
- **Output fallback:** This parameter defines the fallback mode used by the DC transistor outputs when the PLC stops. It can assume the “fallback” value at state 0 or state 1 for the corresponding group of 8 channels or the “maintain” value representing the state of the outputs before the PLC stops.
- **I/O module diagnostics:** Each discrete I/O module is equipped with a display block on the front panel centralizing the information necessary for module control, diagnostics, and maintenance.

Diagnostics via EcoStruxure Control Expert (2):t

Using the integrated diagnostics in EcoStruxure Control Expert (2), local diagnostics screens are available at global hardware configuration level, module level, and channel level.

Remote diagnostics using a Web browser on a “Thin Client” PC:

In addition, the diagnostics described above can be performed remotely using a simple Web browser thanks to the standard Web server integrated in the Modicon X80 modules platform (processor with integrated Ethernet port or Ethernet module), using the “ready-to-use” Rack Viewer function.

- **Compatibility with 2-wire and 3-wire sensors:** The discrete input modules can be used in conjunction with OsiSense XS inductive proximity sensors (for compatibility, see [page 4/30](#)) and with OsiSense XU photoelectric sensors (for compatibility, see [page 4/28](#)).

Complementary characteristics

The following characteristics complement those introduced in the selection guide on pages [4/2](#) to [4/7](#).

DC input modules BMXDDI16●●/1604T/3202K/3232/6402K and BMXDAI1602

- Input impedance at nominal voltage: 6.4 to 19.2 k Ω , depending on model
- Reverse polarity: Protection for modules BMXDDI1602/1603/3202K/3203
- Paralleling of inputs (1): Yes, for modules BMXDDI1602/1603/3232/3203
- Dielectric strength between groups of channels: 500 V $\overline{\text{DC}}$ for modules BXDDI3202K/3203/3232/6402K
- Temperature derating for module BMXDDI1604T: No derating up to 40 °C/104 °F, a maximum of 25% of inputs at state 1 at 70 °C/158 °F

AC input modules BMXDAI16●●/08●●

- Input frequency: 47 to 63 Hz
- Current peak on activation at nominal voltage: 5 to 380 mA depending on model
- Input impedance at nominal voltage and F = 55 Hz: 6 to 28 k Ω , depending on model

Triac output module BMXDAO1605

- Current via common: 2.4 A
- Current for the 4 commons together: 4.8 A

Isolated triac output module BMXDAO1615

- Current per module: 10 A maximum continuous

DC transistor output modules BMXDDO16●●/3202K/6402K

- Dielectric strength between groups of channels: 500 V $\overline{\text{DC}}$ for modules BMXDDO3202K/6402K

(1) For further information, please consult our website at www.se.com.

(2) EcoStruxure Control Expert software continues the Unity Pro range of software and corresponds to versions ≥ 14 of Unity Pro.

Complementary characteristics (continued)

Relay output modules BMXDRA08●●●/1605 and BMXDRC0805

- Protection against AC inductive overvoltage: Use an RC circuit or ZNO surge limiter appropriate to the voltage in parallel on each output.
- Protection against DC inductive overvoltage: Use a discharge diode on each output.

Mixed I/O relay module BMXDDM16025

- Input impedance at nominal voltage: 6.8 kΩ
- Dielectric strength between groups of inputs: 500 V $\overline{\text{---}}$

DC mixed I/O modules BMXDDM16022/3202K

- Input impedance at nominal voltage: 6.8 to 9.6 kΩ, depending on model
- Reverse polarity on the inputs: Protection
- Paralleling of outputs: Yes, for a maximum of 2 outputs for module BMXDDM16022 and a maximum of 3 outputs for module BMXDDM3202K

References

X80 Discrete input modules (1)

Type of current	Input voltage	Connection via (2)	IEC/EN 61131-2 conformity	No. of channels (common)	Reference	Weight kg/lb
$\overline{\text{---}}$	24 V (positive logic)	Caged, screw clamp, or spring-type 20-way removable terminal block	Type 3	16 isolated inputs (1 x 16)	BMXDDI1602	0.115/ 0.254
		One 40-way connector	Type 1	32 isolated inputs (2 x 16)	BMXDDI3202K	0.110/ 0.243
		Two 40-way connectors	Non-type	64 isolated inputs (4 x 16)	BMXDDI6402K	0.145/ 0.320
	24 V (positive/negative logic)	Caged, screw clamp, or spring-type 20-way removable terminal block	Non-type	16 isolated inputs (1 x 16)	BMXDAl1602	0.115/ 0.254
		Caged or spring-type 40-way removable terminal block	Type 3	32 isolated inputs (2 x 16)	BMXDDI3232	0.137/ 0.302
		Caged or spring-type 40-way removable terminal block	Type 3	32 isolated inputs (2 x 16)	BMXDDI3203	0.137/ 0.302
48 V (positive logic)	Caged, screw clamp, or spring-type 20-way removable terminal block	Type 1	16 isolated inputs (1 x 16)	BMXDDI1603	0.115/ 0.254	
125 V (positive logic)	Caged, screw clamp, or spring-type 20-way removable terminal block	Non-type	16 isolated inputs (1 x 16)	BMXDDI1604T	0.144/ 0.317	
\sim	24 V	Caged, screw clamp, or spring-type 20-way removable terminal block	Type 1	16 isolated inputs (1 x 16)	BMXDAl1602	0.115/ 0.254
		Caged, screw clamp, or spring-type 20-way removable terminal block	Type 3	16 isolated inputs (1 x 16)	BMXDAl1603	0.115/ 0.254
	48 V	Caged, screw clamp, or spring-type 20-way removable terminal block	Type 3	16 isolated inputs (1 x 16)	BMXDAl1604	0.115/ 0.254
		Caged or spring-type 40-way removable terminal block	Type 1	16 isolated inputs (1 x 16)	BMXDAl1614	0.157/ 0.346
		Caged or spring-type 40-way removable terminal block	Non-type at 50 Hz Type 1 at 60 Hz	16 isolated inputs (1 x 16)	BMXDAl16142 (3)	0.157/ 0.346
	100...120 V	Caged, screw clamp, or spring-type 20-way removable terminal block	Type 2	8 isolated inputs (1 x 8)	BMXDAl0805	0.120/ 0.265
		Caged or spring-type 40-way removable terminal block	Type 1	16 isolated inputs (1 x 16)	BMXDAl1615	0.157/ 0.346
		Caged, screw clamp, or spring-type 20-way removable terminal block	Type 3	8 isolated inputs (8 x 1)	BMXDAl0814	0.115/ 0.254
		Caged or spring-type 40-way removable terminal block	Type 3	8 isolated inputs (8 x 1)	BMXDAl0814	0.115/ 0.254

(1) This characteristic allows several inputs to be wired in parallel on the same module or on different modules for input redundancy.

(2) 64-channel modules have 2 connectors and therefore require 2 connection cables.

(3) BMXDAl16142 is optimized for 60Hz application, e.g. Quantum modules, while BMXDAl1614 is compatible for both 50Hz and 60 Hz.





BMXDDO16●2



BMXDRA0815/
0805/1605



BMXDDO3202K



BMXDDO6402K



BMXDDM1602●



BMXDDM3202K

References

X80 Discrete output modules (1)

Type of current	Output voltage	Connection via (2)	IEC/EN 61131-2 conformity	No. of channels (common)	Reference	Weight kg/lb
⎓ transistor	24 V/0.5 A (positive logic)	Caged, screw clamp, or spring-type 20-way removable terminal block	Yes	16 protected outputs (1 x 16)	BMXDDO1602	0.120/0.265
	24 V/0.5 A (negative logic)	Caged, screw clamp, or spring-type 20-way removable terminal block	Yes	16 protected outputs (1 x 16)	BMXDDO1612	0.120/0.265
	24 V/0.1 A (positive logic)	One 40-way connector	Yes	32 protected outputs (2 x 16)	BMXDDO3202K	0.110/0.243
		Two 40-way connectors	Yes	64 protected outputs (4 x 16)	BMXDDO6402K	0.150/0.331
~ triac	100...240 V	Caged, screw clamp, or spring-type 20-way removable terminal block	Yes	16 outputs (4 x 4)	BMXDAO1605	0.140/0.309
	24...240 V	Caged, screw clamp, or spring-type 40-way removable terminal block	Yes	16 isolated outputs	BMXDAO1615	0.250/0.551
⎓ relay	100...150 V ⎓/0.3 A	Caged, screw clamp, or spring-type 20-way removable terminal block	Yes	8 non-protected outputs	BMXDRA0804T	0.178/0.392
⎓ or ~ relay	24 V ⎓/2 A	Caged, screw clamp, or spring-type 20-way removable terminal block	Yes	8 non-protected outputs (without common)	BMXDRA0805	0.145/0.320
	24...240 V ~/2 A		Yes			
	24...240 V ~/2 A	Caged, screw clamp, or spring-type 20-way removable terminal block	Yes	8 normally open isolated relay outputs	BMXDRA0815	0.210/0.463
	24...125 V ⎓/0.3 A		Yes			
	24 V ⎓/2 A	Caged, screw clamp, or spring-type 20-way removable terminal block	Yes	16 non-protected outputs (2 x 8)	BMXDRA1605	0.150/0.331
24...240 V ~/2 A	Yes					
	24...240 V ~/2 A	Caged, screw clamp, or spring-type 40-way removable terminal block	Yes	8 normally open/ normally closed isolated relay outputs	BMXDRC0805	0.189/0.417

X80 Discrete mixed I/O modules (1)

Number of I/O	connection	No. of input channels (common)	No. of output channels (common)	IEC/EN 61131-2 conformity	Reference	Weight kg/lb
16	Caged, screw clamp, or spring-type 20-way removable terminal block	8 (positive logic) (1 x 8)	8, transistor 24 V ⎓/0.5 A (1 x 8)	Inputs, type 3	BMXDDM16022	0.115/0.254
			8, relay 24 V ⎓ or 24...240 V ~ (1 x 8)	Inputs, type 3	BMXDDM16025	0.135/0.298
32	Caged, screw clamp, or spring-type 20-way removable terminal block	16 (positive logic) (1 x 16)	16, transistor 24 V ⎓/0.1 A (1 x 16)	Inputs, type 1	BMXDDM3202K	0.110/0.243

(1) Typical consumption: See the power consumption table available on our website www.se.com.

(2) 64-channel modules have 2 connectors and therefore require 2 connection cables.

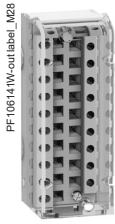

BMXFTB2000

References (continued)

Removable terminal blocks

Description	For use with	Type	Reference	Weight kg/lb
20-way removable terminal blocks	For module with 20-way removable terminal block	Caged	BMXFTB2000	0.093/ 0.205
		Screw clamp	BMXFTB2010	0.075/ 0.165
		Spring	BMXFTB2020	0.060/ 0.132
40-way removable terminal blocks	For standard version of module only with 40-way removable terminal block	Caged	BMXFTB4000	0.166/ 0.366
		Spring	BMXFTB4020	0.098/ 0.216

Preassembled cordsets for 16-channel I/O modules with removable terminal block

Description	Composition	Cross-section	Length m/ft	Reference	Weight kg/lb
Preassembled cordsets with one end with flying leads for 16-channel I/O modules	One 20-way spring-type removable terminal block (BMXFTB2020) and one end with color-coded flying leads	0.324 mm ² / AWG 22	3/9.84	BMXFTW301	0.850/ 1.874
			5/16.4	BMXFTW501	1.400/ 3.086
			10/32.8	BMXFTW1001	2.780/ 6.129

Preassembled cordsets for 16-, 32-, and 64-channel I/O modules with 40-way connectors

Description	No. of sheaths	Composition	Cross-section	Length m/ft	Reference	Weight kg/lb
Preassembled cordsets with one end with flying leads	1 x 20 wires (16 channels)	One 40-way connector and one end with color-coded flying leads	0.324 mm ² / AWG 22	3/9.84	BMXFCW301	0.820/ 1.808
				5/16.4	BMXFCW501	1.370/ 3.020
				10/32.8	BMXFCW1001	2.770/ 6.107
	2 x 20 wires (32 channels) (2)	One 40-way connector and two ends with color-coded flying leads	0.324 mm ² / AWG 22	3/9.84	BMXFCW303	0.900/ 1.984
				5/16.4	BMXFCW503	1.490/ 3.285
				10/32.8	BMXFCW1003	2.960/ 6.526
Preassembled cordsets for Modicon Telefast ABE7 sub-bases	1 x 20 wires (16 channels)	One 40-way connector and one HE 10 connector	0.324 mm ² / AWG 22	0.5/1.64	BMXFCC051	0.140/ 0.309
				1/3.28	BMXFCC101	0.195/ 0.430
				2/6.56	BMXFCC201	0.560/ 1.235
				3/9.84	BMXFCC301	0.840/ 1.852
				5/16.4	BMXFCC501	1.390/ 3.064
				10/32.8	BMXFCC1001	2.780/ 6.123
				0.5/1.64	BMXFCC053	0.210/ 0.463
				1/3.28	BMXFCC103	0.350/ 0.772
				2/6.56	BMXFCC203	0.630/ 1.389
				3/9.84	BMXFCC303	0.940/ 2.072
5/16.4	BMXFCC503	1.530/ 3.373				
10/32.8	BMXFCC1003	3.000/ 6.614				



BMXFTW01



BMXFCW01



BMXFCW03



BMXFCC01

(1) Typical consumption: See the power consumption table available on our website www.se.com.
 (2) 64-channel modules have 2 connectors and therefore require 2 connection cables.

Modicon X80 modules platform

X80 I/O modules Analog input modules

Applications

Analog inputs



Type of input		Isolated low-level inputs, voltage, thermocouples, temperature probes, resistors	
Type		Multirange	
Range	Voltage	± 40 mV, ± 80 mV, ± 160 mV, ± 320 mV, ± 640 mV, ± 1.28 V	
	Current	–	
	Thermocouple Temperature probe	Thermocouples, type B, E, J, K, L, N, R, S, T, U 2-, 3- or 4-wire temperature probes, type Pt100, JPt100, Pt1000, JPt1000, Ni100, Ni1000 (in accordance with DIN43760), and Cu 10	
	Resistor	2-, 3- or 4-wire resistors, 400 Ω or 4000 Ω	
Modularity		4 inputs	8 inputs
Acquisition period		400 ms for the 4 inputs	400 ms for the 8 inputs
Conversion time		–	
Resolution		15 bits + sign	
Isolation	Between channels	750 V $\overline{\text{---}}$	
	Between channels and bus	1400 V $\overline{\text{---}}$	
	Between channels and ground	750 V $\overline{\text{---}}$	
Connection	Directly to the module	Via 40-way connector	Via two 40-way connectors
	Via preassembled cordsets	Cordsets with one end with color-coded flying leads BMXFCW●01S (3 or 5 m/9.84 or 16.4 ft)	
Compatibility with Modicon Telefast ABE7 pre-wired system (1)	Connection sub-base	4-channel sub-base for direct connection of 4 thermocouples plus connection and provision of cold junction compensation	
	Type of connection sub-base	ABE7CPA412	
	Type of preassembled cordsets	BMXFCA●●2 (1.5, 3, or 5 m/4.92, 9.84, or 16.4 ft)	
References		BMXART0414	BMXART0814

(1) For more information, please refer to the "Telefast Pre-wired system – Modicon ABE7 IP20 connection sub-bases" catalog or visit our website www.se.com.

Analog inputs



Isolated high-level inputs	Non-isolated high-level inputs	Isolated high-level inputs
Voltage/current		
± 10 V, 0...10 V, 0...5 V, 1..5 V, ± 5 V		
0...20 mA, 4...20 mA, ± 20 mA		
–		
4 inputs	8 inputs	
Fast: 1 + (1 x no. of declared channels) ms Default: 5 ms for the 4 channels	Fast: 1 + (1 x no. of declared channels) ms Default: 9 ms for the 8 channels	
–		
16 bits	15 bits + sign	
300 V $\overline{\text{---}}$	–	300 V $\overline{\text{---}}$
1400 V $\overline{\text{---}}$		
1400 V $\overline{\text{---}}$		
Via BMXFTB20●0 20-way caged, screw clamp, or spring-type removable terminal block	Via BMXFTB28●0 28-way caged or spring-type removable terminal block	
Cordsets with one end with color-coded flying leads BMXFTW●01S (3 or 5 m/9.84 or 16.4 ft)	Cordsets with one end with color-coded flying leads BMXFTW●08S (3 or 5 m/9.84 or 16.4 ft)	
4-channel sub-base for direct connection of 4 inputs, delivers and distributes 4 protected isolated power supplies	8-channel sub-base for direct connection of 8 current/voltage inputs	
ABE7CPA410	ABE7CPA02/03/31/31E	ABE7CPA02/31/31E
BMXFCA●●0 (1.5, 3, or 5 m/4.92, 9.84, or 16.4 ft)	BMXFTA●●0 (1.5 or 3 m/4.92 or 9.84 ft)	
BMXAMI0410	BMXAMI0800	BMXAMI0810



More technical information on www.se.com



More technical information on www.se.com

Modicon X80 modules platform

X80 I/O modules

Analog output modules and mixed I/O modules

Applications

Analog outputs



Type of I/O		Isolated high-level outputs	Isolated high-level outputs	Non-isolated high-level outputs
Type		Voltage/current		Current
Range	Voltage	± 10 V		–
	Current	0–20 mA, 4–20 mA		
Modularity		2 outputs	4 outputs	8 outputs
Acquisition period (inputs)		–		
Conversion time (outputs)		≤ 1 ms		≤ 4 ms
Resolution	Inputs	–		
	Outputs	15 bits + sign		
Isolation		Between channels: 750 V ∴		
		Between channels and bus: 1400 V ∴		
		Between channels and ground: 1400 V ∴		
Connection	Directly to the module	Via BMXFTB20●0 20-way caged, screw clamp or spring-type removable terminal block		
	Via preassembled cordsets	Cordsets with one end with color-coded flying leads BMXFTW●01S (3 or 5 m/9.84 or 16.4 ft)		
Compatibility with Modicon Telefast ABE7 pre-wired system (1)	Connection sub-base	4-channel sub-base for direct connection of 2/4 current/voltage outputs	8-channel sub-base for direct connection of 8 current/voltage inputs	
	Type of connection sub-base	ABE7CPA21	ABE7CPA02	
	Type of preassembled cordsets	BMXFCA●●0 (1.5, 3, or 5 m/4.92, 9.84, or 16.4 ft)	BMXFTA●●2 (1.5 or 3 m/4.92 or 9.84 ft)	

References	BMXAMO0210	BMXAMO0410	BMXAMO0802
-------------------	-------------------	-------------------	-------------------

Pages	4/22
--------------	------

(1) For more information, please refer to the "Telefast Pre-wired system – Modicon ABE7 IP20 connection sub-bases" catalog or visit our website www.se.com.

Mixed analog I/O



Type of I/O		Non-isolated high-level inputs and outputs
Type		Voltage/current
Range		Inputs: ± 10 V, 0...10 V, 0...5 V, 1..5 V Outputs: ± 10 V
		Inputs: 0–20 mA, 4–20 mA Outputs: 0–20 mA, 4–20 mA
Modularity		4 inputs and 2 outputs
Acquisition period (inputs)		Fast: 1 + (1 x no. of declared channels) ms Default: 5 ms for the 4 channels
Conversion time (outputs)		≤ 1 ms
Resolution		14...12-bit in U range 12-bit in I range
		12-bit in U range 11-bit in I range
Isolation		Between groups of input or output channels: 750 V ∴
		Between channels and bus: 1400 V ∴
		Between channels and ground: 1400 V ∴
Connection		Via BMXFTB20●0 20-way caged, screw clamp or spring-type removable terminal block
		BMXFTW●01S cordsets with one end with color-coded flying leads (3 or 5 m/9.84 or 16.4 ft)
Compatibility with Modicon Telefast ABE7 pre-wired system (1)		–
		–
		–

References	BMXAMM0600
-------------------	-------------------

Pages	4/22
--------------	------

Presentation

The Modicon X80 analog I/O modules offer comprises:

- 5 analog input modules:
 - 2 modules with 4 and 8 isolated channels, low-level voltage, thermocouples, Pt, JPt, Ni, or Cu temperature probes and resistors, 15 bits + sign
BMXART0414/0814
 - 1 module with 4 high-speed isolated analog channels, high-level voltage or current, 16 bits **BMXAMI0410**
 - 2 modules with 8 high-speed non-isolated analog channels, high-level voltage or current, 15 bits + sign **BMXAMI0800/0810**
- 3 analog output modules:
 - 1 module with 2 isolated analog channels, high-level voltage or current, 15 bits + sign **BMXAMO0210**
 - 1 module with 4 isolated analog channels, high-level voltage or current, 15 bits + sign **BMXAMO0410**
 - 1 module with 8 non-isolated analog channels, high-level current, 15 bits + sign **BMXAMO0802**
- 1 mixed analog I/O module with 4 input channels and 2 output channels (non-isolated), voltage or current, 12 to 14 bits according to type of channel and range **BMXAMM0600**

Analog I/O modules are equipped with a connector for a 20 or 28-way removable terminal block, except for **BMXART0414/0814** analog input modules for thermocouples/temperature probes, which are equipped with one or two 40-way connector(s).

All analog modules occupy a single slot in **BMEXBP●●●** or **BMXXBP●●●** racks. These modules can be installed in any slot in the rack, except the first two (PS and 00), which are reserved for the power supply module and the processor module respectively.

The power supply for the analog functions is supplied by the backplane bus (3.3 V and 24 V). Analog I/O modules are hot-swappable (see [page 4/10](#)).

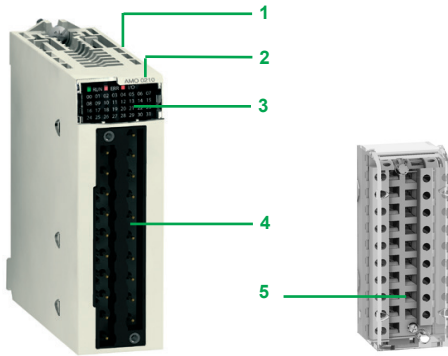

Module for connection via 20 or 28-way removable terminal block

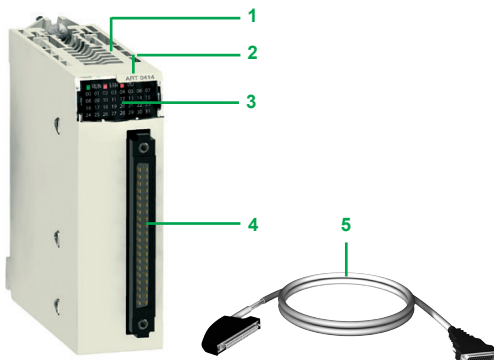

Module for connection via 40-way connector

Description

BMXAM●/ART analog I/O modules are standard format (1 slot). They have a case, which provides IP20 protection of the electronics, and are locked into position by a captive screw.

I/O modules connected via 20 or 28-way removable terminal block

BMXAM● analog I/O modules feature the following:

- 1 A rigid body providing support and protection for the electronic card
- 2 A module reference marking (a label is also visible on the right-hand side of the module)
- 3 A module and channel status display block
- 4 A connector taking the 20 or 28-way removable screw clamp or spring-type terminal block for directly connecting the sensors or preactuators to the module

To be ordered separately (see [page 4/23](#)):

- 5 **BMXFTB20●0** or **BMXFTB28●0** 20 or 28-way removable terminal block (referencing label supplied with each I/O module) or pre-wired cables with:
 - A 20-way terminal block at one end and flying leads at the other (**BMXFTW●01S**)
 - A 28-way terminal block at one end and flying leads at the other (**BMXFTW●08S**)
 - A 20 or 28-way terminal block and a 25-way SUB-D connector (**BMXFCA●●0** or **BMXFTA●●0**), for connection to Modicon Telefast ABE7 sub-bases

I/O modules connected via 40-way connector

BMXART analog input modules have the following on the front panel:

- 1 A rigid body providing support and protection for the electronic card
- 2 A module reference marking (a label is also visible on the right-hand side of the module)
- 3 A module and channel status display block
- 4 One (or two) 40-way connector(s) for connecting the sensors

To be ordered separately (see [page 4/23](#)):

- 5 Pre-wired cables with:
 - A 40-way connector at one end and flying leads at the other (**BMXFCW●01S**)
 - A 40-way connector and a 25-way SUB-D connector (**BMXFCA●●2**) for direct connection to Modicon Telefast ABE7 sub-bases

To be ordered separately (see [page 4/23](#)):

- A **BMXXSP●●00** shielding connection kit to help protect against electrostatic discharge, consisting of a metal bar and two sub-bases for mounting on the rack supporting the analog modules
- A set of **STBXSP3020** clamping rings for the shielding braids of analog signal cables

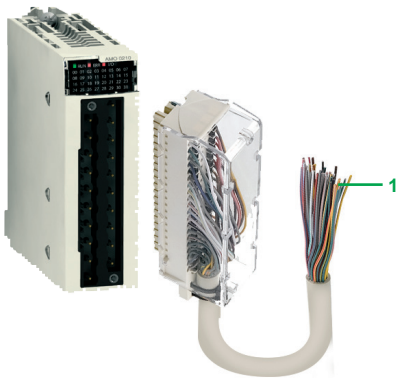

BMXFTW01S cordset
(with 20-way removable terminal block at one end and flying leads at the other)

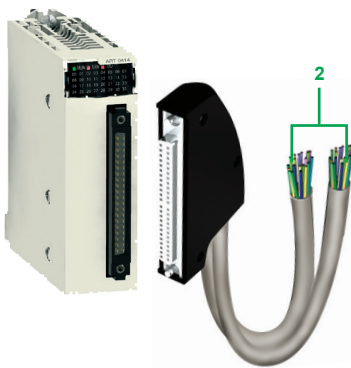

BMXFCW01S cordset
(with 40-way connector at one end and flying leads at the other)

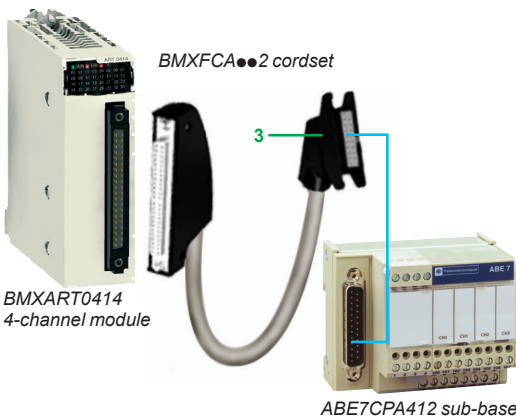

BMXART0414
4-channel module

ABE7CPA412 sub-base

Connecting modules with removable terminal blocks

BMXAMI0410, BMXAMO, and BMXAMM modules with 20-way terminal block

The 20-way removable terminal blocks (BMXFTB2000) are the same as those used for discrete I/O modules (screw clamp, caged, or spring-type) (see page 4/23). One version of the removable terminal block is equipped with a 3 or 5 m/9.84 or 16.4 ft cordset with color-coded flying leads (BMXFTW001S). These preassembled cordsets with reinforced shielding have color-coded flying leads at the other end 1.

BMXAMI0800/0810 modules with 28-way terminal block

The 28-way removable terminal blocks are caged (BMXFTB2800) or spring-type (BMXFTB2820). One version of the removable terminal block is equipped with a 3 or 5 m/9.84 or 16.4 ft cordset with color-coded flying leads (BMXFTW008S). These preassembled cordsets with reinforced shielding have color-coded flying leads at the other end 1.

Connecting modules with 40-way connectors

BMXART014 modules with 40-way connectors

Two types of cordset are available:

- Preassembled cordsets with reinforced shielding (BMXFCW001S) which have color-coded flying leads at the other end 2. Available in 3 or 5 m/9.84 or 16.4 ft lengths, they enable easy direct wire-to-wire connection of the analog sensors via terminal blocks.
- Preassembled cordsets with reinforced shielding (BMXFCA002) which have a 25-way SUB-D connector at the other end 3. Available in 1.5, 3, or 5 m/4.92, 9.84, or 16.4 ft lengths, they enable direct connection to the Modicon Telefast ABE7CPA412 sub-base (see below).

Use with Modicon Telefast ABE7 sub-bases

Using the Modicon Telefast ABE7 pre-wired system makes it easier to install the modules since the inputs (or outputs) can be accessed via screw clamp terminals. Seven special sub-bases are available:

Modicon Telefast ABE7CPA410 sub-base

The Modicon Telefast ABE7CPA410 sub-base is mainly used in conjunction with the BMXAMI0410 voltage/current analog 4-input module. This sub-base allows you to:

- Directly connect 4 sensors
- Remotely locate the input terminals in voltage mode
- Power the 4 to 20 mA conditioning units one channel at a time with a 24 V voltage, protected and limited to 25 mA, while maintaining isolation between channels
- Help protect the current impedance matching resistors integrated in the sub-base against overvoltages

Connection is via the BMXFCA000 cordset (1.5, 3, or 5 m/4.92, 9.84, or 16.4 ft).

Modicon Telefast ABE7CPA412 sub-base

The Modicon Telefast ABE7CPA412 sub-base is specially designed as a wiring interface for the BMXART0414 and BMXART0814 thermocouple modules. This sub-base allows you to:

- Connect 4 thermocouple probes
- Provide external cold junction compensation with a temperature probe integrated in the sub-base
- Provide continuity of the shielding

The BMXART0814 module requires two Modicon Telefast ABE7CPA412 sub-bases. The connection with each sub-base is made via a BMXFCA002 cordset (1.5, 3, or 5 m/4.92, 9.84, or 16.4 ft).

Modicon Telefast ABE7CPA21 sub-base

The Modicon Telefast ABE7CPA21 sub-base is compatible with the BMXAMO0210 output module. This sub-base allows you to:

- Directly connect 2 current/voltage outputs
- Provide continuity of the shielding

Connection is via the BMXFCA000 cordset 3 (1.5, 3, or 5 m/4.92, 9.84, or 16.4 ft).



DIA3ED2160602EN

Use with Modicon Telefast ABE7 sub-bases (continued)

Modicon Telefast ABE7CPA02 sub-base

The Modicon Telefast **ABE7CPA02** sub-base can be used in combination with:

- **BMXAMI0800/0810** analog current input modules with 8 inputs
- **BMXAMO0802** analog current output modules with 8 outputs

This sub-base allows you to:

- Connect the 8 analog inputs or outputs point-to-point
- Provide continuity of the shielding

BMXAMI0800/0810 modules are connected via **BMXFTA●●0** 1.5 or 3 m/4.92 or 9.84 ft cables.

The **BMXAMO0802** module is connected via **BMXFTA●●2** 1.5, 3, or 5 m/4.92, 9.84, or 16.4 ft cables.

Modicon Telefast ABE7CPA03 sub-base

The Modicon Telefast **ABE7CPA03** sub-base can be used in combination with the **BMXAMI0800** voltage/current analog 8-input module.

This sub-base allows you to:

- Directly connect 8 analog inputs
- Power the current inputs one channel at a time with a voltage of 24 V that is protected and limited to 25 mA
- Provide continuity of the shielding

The **BMXAMI0800** module is connected via **BMXFTA●●0** 1.5 or 3 m/4.92 or 9.84 ft cables.

Modicon Telefast ABE7CPA31/31E sub-bases

The Modicon Telefast **ABE7CPA31/31E** sub-bases can be used in combination with the **BMXAMI0800/0810** voltage/current analog 8-input modules.

These sub-bases allow you to:

- Directly connect 8 analog inputs
- Power the current inputs one channel at a time with 24 V converters
- Provide continuity of the shielding

BMXAMI0800/0810 modules are connected via **BMXFTA●●0** 1.5 or 3 m/4.92 or 9.84 ft cables.

Complementary characteristics

BMXART0414/0814 analog input modules

BMXART0414/0814 modules are multirange input modules with 4 or 8 low-level isolated inputs (15 bits + sign) respectively.

Depending on the choice made during configuration, the modules offer, for each of the inputs, the following ranges:

- Temperature probe: Pt100, JPt100, Pt1000, JPt1000, Cu10, Ni100, or Ni1000 (in accordance with DIN43760), with open-circuit detection
- Thermocouple: B, E, J, K, L, N, R, S, T, or U with broken wire detection
- Resistor: 0...400 or 0...4000 Ω , 2-, 3-, or 4-wire
- Voltage: ± 40 mV, ± 80 mV, ± 160 mV, ± 320 mV, ± 640 mV, ± 1.28 V

BMXAMI0410 analog input module

The **BMXAMI0410** module is a high-level analog input module with 4 isolated inputs (16 bits).

Used with sensors or transmitters, it performs monitoring, measurement, and process control functions for continuous processes.

The module offers the following ranges for each of the inputs depending on the choice made during configuration:

- Voltage ± 10 V, ± 5 V, 0...10 V, 0...5 V, and 1...5 V
- Current 0–20 mA, 4–20 mA, and ± 20 mA

BMXAMI0800/0810 analog input modules

BMXAMI0800/0810 analog input modules have 8 high-level isolated/non-isolated analog inputs (15 bits + sign).

The modules offer the following ranges for each of the inputs depending on the choice made during configuration:

- Voltage: ± 10 V, 0...10 V, 0...5 V, 1...5 V, ± 5 V
- Current: 0–20 mA and 4–20 mA

Complementary characteristics (continued)

BMXAMO0210 analog output module

The **BMXAMO0210** module has 2 high-level isolated outputs (15 bits + sign).
The **BMXAMO0210** module offers the following ranges for each of the inputs depending on the choice made during configuration:

- Voltage: ± 10 V
- Current: 0–20 mA and 4–20 mA

BMXAMO0410/0802 analog output modules

BMXAMO0410/0802 analog output modules have 4 or 8 high-level isolated/non-isolated analog outputs (16 bits/15 bits + sign).

The **BMXAMO0410** module offers the following ranges for each of the outputs depending on the choice made during configuration:

- Voltage: ± 10 V
- Current: 0–20 mA and 4–20 mA

The **BMXAMO0802** module offers the current ranges 0–20 mA and 4–20 mA.

BMXAMM0600 analog mixed I/O module

The **BMXAMM0600** mixed module is a non-isolated I/O module with 4 inputs (14/12 bits) and 2 outputs (12 bits). The module offers the following ranges for each of the inputs or outputs depending on the choice made during configuration:

- Voltage: ± 10 V, 0...10 V, 0...5 V, and 1...5 V
- Current: 0–20 mA and 4–20 mA

References

X80 Analog input modules (1)

Type of input	Input signal range	Resolution	Connection via	No. of channels	Reference	Weight kg/lb
Isolated high-level inputs	± 10 V, 0...10 V, 0...5 V, 1...5 V, ± 5 V, 0–20 mA, 4–20 mA, ± 20 mA	16 bits	Caged, screw clamp, or spring-type 20-way removable terminal block	4 channels	BMXAMI0410	0.143/ 0.315
Non-isolated high-level inputs	± 10 V, 0...10 V, 0...5 V, 1...5 V, ± 5 V, 0–20 mA	15 bits + sign	Caged or spring-type 28-way removable terminal block	8 channels	BMXAMI0800	0.175/ 0.386
Isolated high-level inputs	± 10 V, 0...10 V, 0...5 V, 1...5 V, ± 5 V, 0–20 mA	15 bits + sign	Caged or spring-type 28-way removable terminal block	8 channels	BMXAMI0810	0.175/ 0.386
Isolated low-level inputs	Temperature probe, thermocouple, ± 40 mV, ± 80 mV, ± 160 mV, ± 320 mV, ± 640 mV, ± 1.28 V	15 bits + sign	40-way connector	4 channels	BMXART0414	0.135/ 0.298
				8 channels	BMXART0814	0.165/ 0.364

X80 Analog output modules (1)

Type of outputs	Output signal range	Resolution	Connection via	No. of channels	Reference	Weight kg/lb
Isolated high-level outputs	± 10 V, 0–20 mA, 4–20 mA	16 bits	Caged, screw clamp, or spring-type 20-way removable terminal block	2 channels	BMXAMO0210	0.144/ 0.317
High-level outputs isolated	± 10 V, 0–20 mA, 4–20 mA	15 bits + sign	Caged, screw clamp, or spring-type 20-way removable terminal block	4 channels	BMXAMO0410	0.175/ 0.386
Non-isolated high-level inputs	0–20 mA, 4–20 mA	15 bits + sign	Caged, screw clamp, or spring-type 20-way removable terminal block	8 channels	BMXAMO0802	0.175/ 0.386

X80 Analog mixed I/O module (1)

Type of I/O	Signal range	Resolution	Connection via	No. of channels	Reference	Weight kg/lb
Mixed I/O, non-isolated	± 10 V, 0...10 V, 0...5 V, 1...5 V, 0–20 mA, 4–20 mA	14 bits or 12 bits depending on the range	Caged, screw clamp, or spring-type 20-way removable terminal block	Inputs: 4 channels Outputs: 2 channels	BMXAMM0600	0.155/ 0.342

(1) Typical consumption: See the power consumption table available on our website www.se.com.



BMXAMO0210



BMXART0414

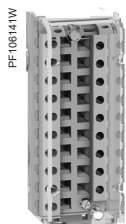

BMXFTB2000



BMXFTW01S



ABE7CPA410/21



BMXFCA000



BMXFCA002

References (continued)

Connection accessories for analog modules (1)

Description	For use with modules	Type, composition	Length	Reference	Weight kg/lb
20-way removable terminal blocks	BMXAMI0410 BMXAMO0210 BMXAMO0410 BMXAMO0802 BMXAMM0600	Caged	–	BMXFTB2000	0.093/ 0.205
		Screw clamp	–	BMXFTB2010	0.075/ 0.165
		Spring	–	BMXFTB2020	0.060/ 0.132
28-way removable terminal blocks	BMXAMI0800 BMXAMI0810	Caged	–	BMXFTB2800	0.111/ 0.245
		Spring	–	BMXFTB2820	0.080/ 0.176
Preassembled cordsets	BMXAMI0410 BMXAMO0210 BMXAMO0410 BMXAMO0802 BMXAMM0600	One 20-way terminal block (BMXFTB2020) and one end with color-coded flying leads	3 m/9.84 ft	BMXFTW301S	0.470/ 1.036
	5 m/16.4 ft		BMXFTW501S	0.700/ 1.543	
	BMXAMI0800 BMXAMI0810	One 28-way removable terminal block (BMXFTB2820) and one end with color-coded flying leads	3 m/9.84 ft	BMXFTW308S	0.435/ 0.959
	5 m/16.4 ft		BMXFTW508S	0.750/ 1.653	
	BMXART0414 BMXART0814	One 40-way connector and one end with color-coded flying leads	3 m/9.84 ft	BMXFCW301S	0.480/ 1.058
	5 m/16.4 ft		BMXFCW501S	0.710/ 1.565	

Modicon Telefast ABE7 pre-wired system

Description	For use with modules	Type, composition	Length or connection technology	Reference	Weight kg/lb
Modicon Telefast ABE7 sub-bases	BMXAMI0410	Distribution of isolated power supplies. Delivers 4 protected isolated power supplies for 4–20 mA inputs. Direct connection of 4 inputs	Screws	ABE7CPA410	0.180/ 0.397
	BMXART0414 BMXART0814 (2)	Connection and provision of cold-junction compensation for thermocouples Direct connection of 4 inputs	Screws	ABE7CPA412	0.180/ 0.397
	BMXAMO0210 BMXAMO0410	Direct connection of 2/4 outputs	Screws	ABE7CPA21	0.210/ 0.463
	BMXAMI0800 BMXAMI0810 BMXAMO0802	Point-to-point connection of 8 I/O	Screws	ABE7CPA02	0.317/ 0.699
	BMXAMI0800	Direct connection of 8 inputs. Delivers 8x 24 V \pm power supplies limited to 25 mA to the 8 current inputs	Screws	ABE7CPA03	0.307/ 0.677
	BMXAMI0800 BMXAMI0810	Direct connection of 8 inputs Delivers 8x 24 V \pm power supplies isolated and limited to 25 mA to the 8 current inputs	Screws	ABE7CPA31	0.498/ 1.098
			Spring	ABE7CPA31E	0.508/ 1.120
Preassembled cordsets for Modicon Telefast ABE7 sub-bases	BMXAMI0410 BMXAMO0210 BMXAMO0410	One 20-way removable terminal block and one 25-way SUB-D connector for ABE7CPA410/CPA21 sub-base	1.5 m/4.92 ft	BMXFCA150	0.320/ 0.705
	3 m/9.84 ft		BMXFCA300	0.500/ 1.102	
	5 m/16.4 ft		BMXFCA500	0.730/ 1.609	
	BMXART0414 BMXART0814 (2)	One 40-way connector and one 25-way SUB-D connector for ABE7CPA412 sub-base	1.5 m/4.92 ft	BMXFCA152	0.330/ 0.728
	3 m/9.84 ft		BMXFCA302	0.510/ 1.124	
	5 m/16.4 ft		BMXFCA502	0.740/ 1.631	
	BMXAMI0800 BMXAMI0810	One 28-way removable terminal block and one 25-way SUB-D connector for sub-bases ABE7CPA02/03/31/31E	1.5 m/4.92 ft	BMXFCA150	0.374/ 0.825
	3 m/9.84 ft		BMXFCA300	0.500/ 1.102	
	BMXAMO0802	One 20-way removable terminal block and one 25-way SUB-D connector for ABE7CPA02 sub-bases	1.5 m/4.92 ft	BMXFCA152	0.374/ 0.825
	3 m/9.84 ft		BMXFCA302	0.500/ 1.102	

(1) The shielding on the cordsets carrying the analog signals must always be connected to the [BMXXSP000](#) shielding connection kit mounted under the rack holding the analog modules (see [page 2/3](#)).

(2) The [BMXART0814](#) 8-channel module requires two [ABE7CPA412](#) sub-bases and two [BMXFCA002](#) cordsets.

Applications

HART analog inputs



Type of I/O		Isolated analog inputs with HART
Number of channels		8
Range	Current	4-20 mA
Maximum load impedance		—
Operating temperature		0...60°C/32...140°F
Compatible devices		BMEP58●●●● processors, BMECRA31210 drop module, BMEXBP●●●00(H) Ethernet + X-bus backplanes, 140NOC78000 Quantum Ethernet DIO module
Resolution		15 bits + sign
Isolation	Between channels	1000 V $\overline{\text{---}}$ for 1 minute
	Between channels and bus	1400 V $\overline{\text{---}}$ for 1 minute
	Between channels and ground	1400 V $\overline{\text{---}}$ for 1 minute
Connection	Directly to the module	Via BMXFTB20●0 20-way caged, screw clamp, or spring-type removable terminal block
Compatibility with pre-wired ABE7	Connection sub-base	8-channel sub-base for direct connection of 8 current/voltage inputs
	Type of connection sub-base	ABE7CPA02/03/31
	Type of preassembled cordsets	BMXFCA1522/3022 (1.5 or 3 m/4.92 or 9.84 ft)
Field device support		2-wire/4-wire
HART specification	HART field device compliance	HART V5, V6, V7
	HART field device connection	Point-to-point
	HART I/O mapping	Yes

References **BMEAH0812**

Page 4/21

HART analog outputs



Type of I/O		Isolated analog outputs with HART
Number of channels		4
Range	Current	4-20 mA
Maximum load impedance		600 Ω (0-20 mA)
Operating temperature		0...60°C/32...140°F
Compatible devices		BMEP58●●●● processors, BMECRA31210 drop module, BMEXBP●●●00(H) Ethernet + X-bus backplanes, 140NOC78000 Quantum Ethernet DIO module
Resolution		15 bits + sign
Isolation	Between channels	1000 V $\overline{\text{---}}$ for 1 minute
	Between channels and bus	1400 V $\overline{\text{---}}$ for 1 minute
	Between channels and ground	1400 V $\overline{\text{---}}$ for 1 minute
Connection	Directly to the module	Via BMXFTB20●0 20-way caged, screw clamp, or spring-type removable terminal block
Compatibility with pre-wired ABE7	Connection sub-base	4-channel sub-base for direct connection of 2/4 current/voltage outputs
	Type of connection sub-base	ABE7CPA21
	Type of preassembled cordsets	BMXFCA150/300/500 (1.5, 3, or 5 m/4.92, 9.84, or 16.4 ft)
Field device support		2-wire/4-wire
HART specification	HART field device compliance	HART V5, V6, V7
	HART field device connection	Point-to-point
	HART I/O mapping	Yes

References **BMEAHO0412**

Page 4/21

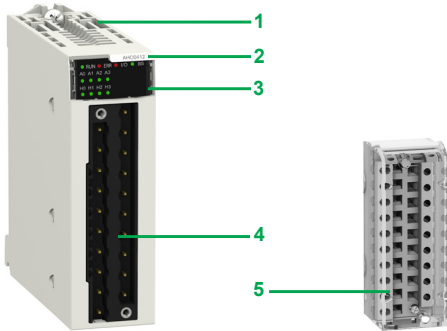

Module for connection via 20-way removable terminal block



DIA6ED2151012EN

Presentation

BMEAH●0●12 HART analog I/O modules contain transceivers that control HART devices and information through the module. They can be managed by the AMS (Asset Management System) or by the automation platform CPU.

These modules require an Ethernet + X-bus backplane and can only be installed in the main local rack with the CPU or in RIO drops with a **BMECRA31210** X80 Remote I/O drop performance adapter. They cannot be installed in expansion racks.

Description

BMEAH●0●12 HART analog I/O modules are standard format (1 slot). They have a case, which provides IP20 protection of the electronics, and are locked into position by a captive screw. They are connected via a 20-way removable terminal block.

BMEAH●0●12 HART analog I/O modules feature the following:

- 1 A rigid body providing support and protection for the electronic card
- 2 A module reference marking (a label is also visible on the right-hand side of the module)
- 3 A module and channel status display block
- 4 A connector taking the 20-way removable screw clamp or spring-type terminal block for directly connecting the sensors or preactuators to the module

To be ordered separately (see [page 4/23](#)):

- 5 A **BMXFTB20●0** 20-way removable terminal block (referencing label supplied with each I/O module) or pre-wired cables with:
 - A 20-way terminal block at one end and flying leads at the other (**BMXFTW●01S**)
 - A 20-way terminal block and a 25-way SUB-D connector (**BMXFCA●●0** or **BMXFTA●●22**), for connection to Modicon Telefast ABE 7 sub-bases

Connecting modules using 20-way removable terminal blocks

The 20-way removable terminal blocks (**BMXFTB20●0**) are the same as those used for discrete I/O modules (screw clamp, caged or spring-type) (see [page 4/23](#)).

One version of the removable terminal block is equipped with a 3 or 5 m/9.84 or 16.4 ft cordset with color-coded flying leads (**BMXFTW●01S**). These preassembled cordsets with reinforced shielding have color-coded flying leads at the other end.



BMXFTW●01S



BMXFCA●●0

Use with Modicon Telefast ABE7 sub-bases

Modicon Telefast ABE7CPA21 sub-base

The Modicon Telefast **ABE7CPA21** sub-base is compatible with the **BMEAH00412** output module.

This sub-base allows you to:

- Directly connect two current/voltage outputs
- Ensure continuity of the shielding

Connection is via the **BMXFCA●●0** cordset (1.5, 3, or 5 m/4.92, 9.84, or 16.4 ft long).

Modicon Telefast ABE7CPA02 sub-base

The Modicon Telefast **ABE7CPA02** sub-base can be used with the **BMEAH10812** HART analog input module.

This sub-base allows you to:

- Connect the 8 analog inputs point-to-point
- Ensure continuity of the shielding

The **BMEAH10812** module is connected by means of the 1.5 or 3 m/4.92 or 9.84 ft long **BMXF1522/3022** cables.



DIA3ED2160602EN

Use with Modicon Telefast ABE7 sub-bases

Modicon Telefast ABE7CPA03 sub-base

The Modicon Telefast **ABE7CPA03** sub-base can be used with the **BMEAHI0812** HART analog input module.

This sub-base allows you to:

- Directly connect the 8 analog inputs
- Power the current inputs one channel at a time with a voltage of 24 V that is protected and limited to 25 mA
- Ensure continuity of the shielding

The **BMEAHI0812** module is connected by means of the 1.5 or 3 m/4.92 or 9.84 ft long **BMXFTA1522/3022** cables (1).

Modicon Telefast ABE7CPA31 sub-base

The Modicon Telefast **ABE7CPA31** sub-base can be used with the **BMEAHI0812** HART analog input module.

This sub-base allows you to:

- Directly connect the 8 analog inputs
- Power the current inputs one channel at a time with 24 V converters
- Ensure continuity of the shielding

The **BMEAHI0812** module is connected by means of the 1.5 or 3 m/4.92 or 9.84 ft long **BMXFTA1522/3022** cables.

Additional characteristics

BMEAHI0812 HART analog input module

The **BMEAHI0812** module is a module with 8 high-level isolated inputs (15 bits + sign).

The **BMEAHI0812** module offers the current range 4 - 20 mA for each of the inputs depending on the choice made during configuration.

BMEAHO0412 HART analog output module

The **BMEAHO0412** module is a module with 4 high-level isolated outputs (15 bits + sign).

The **BMEAHO0412** module offers the current range 4 - 20 mA for each of the inputs depending on the choice made during configuration.

References

X80 HART analog input module

Type of input	Input signal range	Resolution	Connection via	No. of channels	Reference	Weight kg/lb
Isolated high-level inputs	4 - 20 mA	15 bits + sign	Caged, screw clamp, or spring-type 20-way removable terminal block	8 channels	BMEAHI0812	0.233/0.514

X80 HART analog output module

Type of input	Output signal range	Resolution	Connection via	No. of channels	Reference	Weight kg/lb
Isolated high-level outputs	4 - 20 mA	15 bits + sign	Caged, screw clamp, or spring-type 20-way removable terminal block	4 channels	BMEAHO0412	0.223/0.492

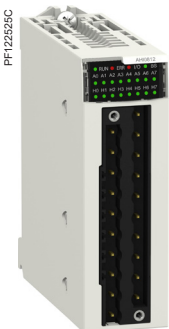

BMEAHI0812

(1) The **BMEAHI0812** HART analog input module loses its isolation between channels when connected to the Modicon Telefast **ABE7CPA03** sub-base.

Modicon X80 modules platform

X80 I/O modules
Inputs and OsiSense XU photoelectric sensors
compatibility

Photoelectric sensors				⋮ inputs, BMXDDI					⋮ inputs, BMXDDM			⋮ inputs, BMXAMI		~ inputs, BMXDAI						
Type	Reference			1602	1603	1604T	3202K	6402K	16022	16025	3202K	0810	0800	1602	1603	1604	0805	0814		
General purpose																				
Design Ø 18	Metal	3-wire, PNP 24V	XUB0/1/2/4/5/9B●P●●●																	
		3-wire, NPN 24V	XUB0/1/2/4/5/9B●N●●●																	
	Plastic	3-wire, PNP 24V	XUB0/1/2/4/5/9A●P●●●																	
		3-wire, NPN 24V	XUB0/1/2/4/5/9A●N●●●																	
Design	Miniature	3-wire, PNP 24V	XUM0/2/5/9AP●●●●																	
		3-wire, NPN 24V	XUM0/2/5/9AN●●●●																	
	Compact 50x50	3-wire, PNP 24V	XUK1/2/5/8/9AP●●●																	
		3-wire, NPN 24V	XUK1/2/5/8/9AN●●●																	
		3-wire, programmable PNP/NPN DC	XUK0AK●●●																	
	Compact 92x71	5-wire, programmable AC/DC	XUK0/1/2/5/8/9AR																	
		3-wire, programmable PNP/NPN DC	XUX0/1/2/5/8/9AK																	
		5-wire, programmable AC DC	XUX0/1/2/5/8/9AR																	
Application																				
Material handling	Optical fork	3-wire, PNP 24V	XUVR●●●●P●●																	
		3-wire, NPN 24V	XUVR●●●●N●●																	
		3-wire, PNP 24V	XUVA●●●●P●●																	
		3-wire, NPN 24V	XUVA●●●●N●●																	
		4-wire, PNP, or NPN 24V	XUYF●●●●●																	
		4-wire, PNP, or NPN 24V	XUVU06●●●																	
		4-wire, PNP, or NPN 24V	XUVK●●●																	
		3-wire, PNP 24V	XUVH●●●																	
		3-wire, NPN 24V	XUVJ●●●																	
		4-wire, PNP, or NPN 24V	XUVF●●●																	
		Packaging	Fiber	4-wire, PNP, or NPN 24V	XUYDCF●●●															
			Compact	4-wire, PNP, or NPN 24V	XUK●S●●●●															
M 18, threaded	3-wire, PNP 24V		XU5M18U1D																	
Fiber	4-wire, PNP, or NPN 24V		XUYAFL●●●																	
M 18, threaded	3-wire, PNP 24V		XUBT●P●●●																	
	3-wire, NPN 24V		XUBT●N●●●																	
Compact	4-wire, PNP, or NPN 24V		XUKT●●●																	
	3-wire, PNP 24V		XUKC1N●●●																	
	3-wire, NPN 24V		XUKC1P●●●																	
	3-wire, PNP 24V		XURC3P●●●																	
	3-wire, NPN 24V		XURC3N●●●																	
	4-wire, PNP, or NPN 24V		XUMW●●●																	
M 18, threaded	3-wire, PNP 24V		XUB0SP●●●																	
	3-wire, NPN 24V		XUB0SN●●●																	
	3-wire, PNP 24V		XU●N18P●●●																	
	3-wire, NPN 24V		XU●N18N●●●																	
M 8, threaded	3-wire, PNP 24V		XUAH●●●																	
	3-wire, NPN 24V		XUAJ●●●																	
Miniature	3-wire, PNP 24V		XUYP●●●●P●●																	
	3-wire, NPN 24V		XUYP●●●●N●●																	
	3-wire, PNP 24V		XUM2/5/9BP●●●																	
	3-wire, NPN 24V		XUM2/5/9BN●●●																	
	3-wire, PNP 24V		XUY●●●929●●																	
	3-wire, PNP 24V		XUY●●●929●●																	
Hoisting	M 18, threaded	3-wire, PNP 24V	XUBLBP●●●																	
		3-wire, NPN 24V	XUBLBN●●●																	
	Compact	2-wire 4...20 mA; 3-wire 0...10V	XUJK803538																	
	M 18, threaded	2-wire 4...20 mA	XU5M18AB20D																	
		PNP, 2-wire 4...20 mA	XU2M18AB20D																	
	Compact	PNP, 2-wire 4...20 mA	XUYP●●●925																	
		4-wire, PNP, or NPN 24V	XUYPS●●●																	
	Fiber	3-wire, PNP 24V	XUDA●P●●●																	
		3-wire, NPN 24V	XUDA●N●●●																	
		4-wire, PNP, or NPN 24V	XUYAF●●●																	
	Other formats	3-wire, programmable PNP/NPN DC	XUC2/8/9AK●●●																	
		5-wire, programmable AC/DC	XUC2/8/9ARC●●●																	
		3-wire, NPN 24V + analog	XUE●AA●●●																	
		2-wire, AC	XULA●●●																	
		5-wire, programmable AC/DC	XULM●●●																	
		3-wire, programmable PNP/NPN DC	XUYB●●●S																	
		5-wire, programmable AC/DC	XUYB●●●R																	
		M 18, threaded	2-wire, AC/DC	XU5/8/9M18MA●●●																

Compatible
Incompatible

Modicon X80 modules platform

X80 I/O modules
Inputs and OsiSense XS inductive proximity sensors compatibility

Proximity sensors				⋮ inputs, BMXDDI					⋮ inputs, BMXDDM			⋮ inputs, BMXAMI		~ inputs, BMXDAI							
Type	Reference			1602	1603	1604T	3202K	6402K	16022	16025	3202K	0810	0800	1602	1603	1604	0805	0814			
General purpose																					
Cylindrical, flush, standard sensing distance, short barrel	Ø 6.5 plain short	3-wire, PNP 24V	XS506B1P●●●																		
		3-wire, NPN 24V	XS506B1N●●●																		
		2-wire, DC 24V	XS506BSC●●●																		
	M8, threaded short	3-wire, PNP 24V	XS508B1P●●●																		
		3-wire, NPN 24V	XS508B1N●●●																		
		2-wire, DC 24V	XS508BSC●●●																		
	M12, threaded short	3-wire, PNP 24V	XS512B1P●●●																		
		3-wire, NPN 24V	XS512B1N●●●																		
		2-wire, DC 24V	XS512BSD/C●●●																		
	M18, threaded short	3-wire, PNP 24V	XS518B1P●●●																		
		3-wire, NPN 24V	XS518B1N●●●																		
		2-wire, DC 24V	XS518BSD/C●●●																		
M30, threaded short	3-wire, PNP 24V	XS530B1P●●●																			
	3-wire, NPN 24V	XS530B1N●●●																			
	2-wire, DC 24V	XS530BSD/C●●●																			
Cylindrical, flush, standard sensing distance, long barrel	M8, threaded long	3-wire, PNP 24V-48V	XS508BLP●●●																		
		3-wire, NPN 24V-48V	XS508BLN●●●																		
		2-wire, DC 24V-48V	XS508B1D/C●●●																		
	M12, threaded long	3-wire, PNP 24V-48V	XS512BLP●●●																		
		3-wire, NPN 24V-48V	XS512BLN●●●																		
		2-wire, DC 24V-48V	XS512B1D/C●●●																		
	M18, threaded long	3-wire, PNP 24V-48V	XS518BLP●●●																		
		3-wire, NPN 24V-48V	XS518BLN●●●																		
		2-wire, DC 24V-48V	XS518B1D/C●●●																		
	M30, threaded long	3-wire, PNP 24V-48V	XS530BLP●●●																		
		3-wire, NPN 24V-48V	XS530BLN●●●																		
		2-wire, DC 24V-48V	XS530B1D/C●●●																		
M12, threaded long	2-wire, AC/DC	XS512B1M●●●																			
M18, threaded long	2-wire, AC/DC	XS518B1M●●●																			
M30, threaded long	2-wire, AC/DC	XS530B1M●●●																			
Cylindrical, flush, extended sensing distance, short barrel	Ø 6.5 plain short	3-wire, PNP 24V	XS106B3P●●●																		
		3-wire, NPN 24V	XS106B3N●●●																		
		2-wire, DC 24V	XS606B3C●●●																		
	M8, threaded short	3-wire, PNP 24V	XS108B3P●●●																		
		3-wire, NPN 24V	XS108B3N●●●																		
		2-wire, DC 24V	XS608B3C●●●																		
	M12, threaded short	3-wire, PNP 24V	XS112B3P●●●																		
		3-wire, NPN 24V	XS112B3N●●●																		
		2-wire, DC 24V	XS612B3D●●●																		
	M18, threaded short	3-wire, PNP 24V	XS118B3P●●●																		
		3-wire, NPN 24V	XS118B3N●●●																		
		2-wire, DC 24V	XS618B3D●●●																		
M30, threaded short	3-wire, PNP 24V	XS130B3P●●●																			
	3-wire, NPN 24V	XS130B3N●●●																			
	2-wire, DC 24V	XS630B3D●●●																			
Cylindrical, flush, extended sensing distance, long barrel	M8, threaded long	3-wire, PNP 24V-48V	XS608B1P●●●																		
		3-wire, NPN 24V-48V	XS608B1N●●●																		
		2-wire, DC 24V-48V	XS608B1D●●●																		
	M12, threaded long	3-wire, PNP 24V-48V	XS612B1P●●●																		
		3-wire, NPN 24V-48V	XS612B1N●●●																		
		2-wire, DC 24V-48V	XS612B1D●●●																		
	M18, threaded long	3-wire, PNP 24V-48V	XS618B1P●●●																		
		3-wire, NPN 24V-48V	XS618B1N●●●																		
		2-wire, DC 24V-48V	XS618B1D●●●																		
	M30, threaded long	3-wire, PNP 24V-48V	XS630B1P●●●																		
		3-wire, NPN 24V-48V	XS630B1N●●●																		
		2-wire, DC 24V-48V	XS630B1D●●●																		
M12, threaded long	2-wire, AC/DC	XS612B1M●●●																			
M18, threaded long	2-wire, AC/DC	XS618B1M●●●																			
M30, threaded long	2-wire, AC/DC	XS630B1M●●●																			
Cylindrical, non flush, extended sensing distance, long barrel	M12, threaded long	3-wire, PNP 24V-48V	XS612B4P●●●																		
		3-wire, NPN 24V-48V	XS612B4N●●●																		
	M18, threaded long	3-wire, PNP 24V-48V	XS618B4P●●●																		
		3-wire, NPN 24V-48V	XS618B4N●●●																		
	M30, threaded long	3-wire, PNP 24V-48V	XS630B4P●●●																		
		3-wire, NPN 24V-48V	XS630B4N●●●																		
M12, threaded long	2-wire, AC/DC	XS612B4M●●●																			
M18, threaded long	2-wire, AC/DC	XS618B4M●●●																			
M30, threaded long	2-wire, AC/DC	XS630B4M●●●																			

Compatible
Incompatible

Modicon X80 modules platform

X80 I/O modules
Inputs and OsiSense XS inductive proximity sensors
compatibility

Proximity sensors			⋮ inputs, BMXDDI					⋮ inputs, BMXDDM			⋮ inputs, BMXAMI		~ inputs, BMXDAI						
Type	Reference		1602	1603	1604T	3202K	6402K	16022	16025	3202K	0810	0800	1602	1603	1604	0805	0814		
General purpose																			
Flat, flush mountable, standard sensing distance	Format J 8x22x8	3-wire, PNP 24V	XS7J1A1P●●●																
		3-wire, NPN 24V	XS7J1A1N●●●																
		2-wire, DC 24V	XS7J1A1D●●●																
		Format F 15x22x8	3-wire, PNP 24V	XS7F1A1P●●●															
			3-wire, NPN 24V	XS7F1A1N●●●															
			2-wire, DC 24V	XS7F1A1D●●●															
	Format E 26x26x13	3-wire, PNP 24V	XS7E1A1P●●●																
		3-wire, NPN 24V	XS7E1A1N●●●																
		2-wire, DC 24V	XS7E1A1D/C●●●																
	Format C 40x40x15	3-wire, PNP 24V	XS7C1A1P●●●																
		3-wire, NPN 24V	XS7C1A1N●●●																
		2-wire, DC 24V	XS7C1A1D/C●●●																
Format D 80x80x26	3-wire, PNP 24V	XS7D1A1P●●●																	
	3-wire, NPN 24V	XS7D1A1N●●●																	
	2-wire, DC 24V	XS7D1A1D/C●●●																	
Format 40x40x70 and 40x40x117 Plastic, with turret head: 5 positions	NO + NC	4-wire, PNP 24V-48V	XS7XS8C2/C4A1/A4P●●●																
		4-wire, NPN 24V-48V	XS7XS8C2/C4A1/A4N●●●																
	NO/NC programmable	2-wire, DC 24V-48V	XS7XS8C2/C4A1/A4D●●●																
		2-wire, AC/DC	XS7XS8C2/C4A1/A4M●●●																
Flat, flush mountable, extended sensing distance	Format E 26x26x13	3-wire, PNP 24V	XS8E1A1P●●●																
		3-wire, NPN 24V	XS8E1A1N●●●																
		2-wire, AC/DC	XS8E1A1M●●●																
	Format C 40x40x15	3-wire, PNP 24V	XS8C1A1P●●●																
		3-wire, NPN 24V	XS8C1A1N●●●																
		2-wire, AC/DC	XS8C1A1M●●●																
	Format D 80x80x26	3-wire, PNP 24V	XS8D1A1P●●●																
		3-wire, NPN 24V	XS8D1A1N●●●																
		2-wire, AC/DC	XS8D1A1M●●●																
	Cylindrical multi-voltage	M12, threaded	2-wire, AC/DC	XS12M12M●250															
		M18, threaded	2-wire, AC/DC	XS12M18M●250															
		M30, threaded	2-wire, AC/DC	XS12M30M●250															
Cylindrical metal, 4-wire	Ø 6.5, plain	4-wire, PNP 24V	XS1L06PC410																
		4-wire, NPN 24V	XS1L06NC410																
	M8, threaded	4-wire, PNP 24V	XS12M08PC410●																
		4-wire, NPN 24V	XS12M08NC410●																
	M12, threaded	4-wire, PNP 24V	XS12N12PC410●																
		4-wire, NPN 24V	XS12N12NC410●																
	M18, threaded	4-wire, PNP 24V	XS12N18PC410●																
		4-wire, NPN 24V	XS12N18NC410●																
	M30, threaded	4-wire, PNP 24V	XS12N30PC410●																
		4-wire, NPN 24V	XS12N30NC410●																
	Cylindrical metal, 4-wire PNP + NPN	M12, threaded	4-wire, PNP+NPN, prog. 24V	XS12/4M12KP340●															
		M18, threaded	4-wire, PNP+NPN, prog. 24V	XS12/4M18KP340●															
M30, threaded		4-wire, PNP+NPN, prog. 24V	XS12/4M30KP340●																
Cylindrical plastic, non flush, standard sensing distance	M8, threaded	3-wire, PNP 24V	XS4P08P●340●																
		3-wire, PNP 24V-48V	XS4P08P●370●																
		3-wire, NPN 24V	XS4P08N●340●																
		3-wire, NPN 24V-48V	XS4P08N●370●																
		2-wire, AC/DC	XS4P08M●230●●●																
	M12, threaded	3-wire, PNP 24V	XS4P12P●340●																
		3-wire, PNP 24V-48V	XS4P12P●370●																
		3-wire, NPN 24V	XS4P12N●340●																
		3-wire, NPN 24V-48V	XS4P12N●370●																
		2-wire, AC/DC	XS4P12M●230●●●																
	M18, threaded	3-wire, PNP 24V	XS4P18P●340●																
		3-wire, PNP 24V-48V	XS4P18P●370●																
		3-wire, NPN 24V	XS4P18N●340●																
		3-wire, NPN 24V-48V	XS4P18N●370●																
		2-wire, AC/DC	XS4P18M●230●●●																
	M30, threaded	3-wire, PNP 24V	XS4P30P●340●																
		3-wire, PNP 24V-48V	XS4P30P●370●																
		3-wire, NPN 24V	XS4P30N●340●																
		3-wire, NPN 24V-48V	XS4P30N●370●																
		2-wire, AC/DC	XS4P30M●230●●●																

Compatible
Incompatible

Modicon X80 modules platform

X80 I/O modules
Inputs and OsiSense XS inductive proximity sensors
compatibility

Proximity sensors				⋮ inputs, BMXDDI				⋮ inputs, BMXDDM			⋮ inputs, BMXAMI		~ inputs, BMXDAI						
Type	Reference			1602	1603	1604T	3202K	6402K	16022	16025	3202K	0810	0800	1602	1603	1604	0805	0814	
General purpose																			
Cylindrical basic flush or non flush, standard sensing distance Plastic or metal	Ø 6.5 plain	3-wire, PNP 24V	XS1/206BLP●●●																
		3-wire, NPN 24V	XS1/206BLN●●●																
	M8, threaded	3-wire, PNP 24V	XS1/208A/BLP●●●																
		3-wire, NPN 24V	XS1/208A/BLN●●●																
	M12, threaded	3-wire, PNP 24V	XS1/212A/BLP●●●																
		3-wire, NPN 24V	XS1/212A/BLN●●●																
	M18, threaded	3-wire, PNP 24V	XS1/218A/BLP●●●																
		3-wire, NPN 24V	XS1/218A/BLN●●●																
	M30, threaded	3-wire, PNP 24V	XS1/230A/BLP●●●																
		3-wire, NPN 24V	XS1/230A/BLN●●●																
	Cylindrical, almost flush, extended sensing distance	M18, threaded	3-wire, PNP 24V	XS1N18P●349●															
			3-wire, NPN 24V	XS1N18N●349●															
M30, threaded		3-wire, PNP 24V	XS1N30P●349●																
		3-wire, NPN 24V	XS1N30N●349●																
Cylindrical, miniature	Ø 4 plain	3-wire, PNP 24V	XS1L04P●31●●																
		3-wire, NPN 24V	XS1L04N●31●●																
	M5, threaded	3-wire, PNP 24V	XS1N05P●31●●																
		3-wire, NPN 24V	XS1N05N●31●●																
	Ø 6.5 plain	3-wire, PNP 24V	XS2L06P●340●																
		3-wire, NPN 24V	XS2L06N●340●																
Application																			
Cylindrical, adjustable sensing distance	M12, threaded	3-wire, PNP 24V	XS612B2P●●●																
		3-wire, NPN 24V	XS612B2N●●●																
	M18, threaded	3-wire, PNP 24V	XS618B2P●●●																
		3-wire, NPN 24V	XS618B2N●●●																
M30, threaded	3-wire, PNP 24V	XS630B2P●●●																	
	3-wire, NPN 24V	XS630B2N●●●																	
Rotation monitoring	M18, threaded	3-wire, PNP 24V-48V	XSAV11/2373																
		2-wire, AC/DC	XSAV11/2801																
		Format E 26x26x13	3-wire, PNP 24V	XS9●11RP●●●●															
Analog output	M12, threaded	2-wire 4...20mA; 3-wire 0...10V	XS●12AB●●●●																
		2-wire 4...20mA; 3-wire 0...10V	XS●18AB●●●●																
		2-wire 4...20mA; 3-wire 0...10V	XS●30AB●●●●																
		2-wire 4...20mA; 3-wire 0...10V	XS9C2/C4A2A●●●●																
		Block format	2-wire 4...20mA; 3-wire 0...10V	XS9●111A●●●●															
Food and beverage	Cylindrical threaded metal	3-wire, PNP 24V	XS2●●SAP●●●																
		3-wire, PNP 24V	XS908/12/18/30R/S●P●●●																
		3-wire, NPN 24V	XS2●●SAN●●●																
	Cylindrical threaded plastic	2-wire, AC/DC	XS2●●SAMA●●●																
		3-wire, PNP 24V-48V	XS2●●AAP●●●																
		3-wire, NPN 24V	XS2●●AAN●●●																
Factor 1	Cylindrical threaded metal	2-wire, AC/DC	XS2●●AAMA●●●																
		4-wire, PNP+NPN 24V	XS1M●●KPM40																
		4-wire, PNP+NPN 24V	XS9C2/C4A●●●●																
Packaging	Cylindrical threaded metal	3-wire, PNP 24V	XS1M18PAS●●																
		3-wire, PNP 24V	XS7G12P●140																
		3-wire, NPN 24V	XS7G12N●140																
		4-wire, PNP 24V-48V	XS7G12P●440																
		4-wire, NPN 24V-48V	XS7G12N●440																
Material handling	Format C 40x40x40	2-wire, AC/DC	XS7G12M●230																
		2-wire, DC 24V-48V	XS7T4DA●●●																
		4-wire, PNP 24V-48V	XS7T4PC●●●																
		4-wire, NPN 24V-48V	XS7T4NC●●●																
Welding	Format D 80x80x26	2-wire, DC 24V-48V	XS7D1●●●●																
		3-wire, PNP 24V	XS1M●●PAW●●																
		2-wire, DC 24V-48V	XSLC●●●																

Compatible
Incompatible

Selection guide page 5/2

X80 Safety power supplies

- Presentation, description page 5/4
- Functions, references page 5/5

X80 Safety discrete I/O modules

- Presentation..... page 5/6
- Description, connections page 5/7
- References page 5/8

X80 Safety analog I/O module

- Presentation, description, connections page 5/9
- References page 5/9

Applications		16-channel Safety discrete input module
		
Type	DC	
Voltage	24 V	
Current per channel	3.5 mA	
Range	Voltage	–
	Current	–
Modularity	Number of channels	16
	Number of groups	2: 0...3 (banks A & B) and 4...7 (banks A & B)
	Number of channels per common	8
Acquisition period	Hot-swap RAID HDD and battery backup	–
Resolution	–	
Connection	Via BMXFTB20●0 20-way caged, screw clamp, or spring-type removable terminal block	
Isolated inputs	IEC/EN 61131-2 conformity	Type 3
	Logic	Positive
	Type of input	–
	Sensor compatibility IEC/EN 60947-5-2	2-wire/3-wire
Isolated outputs	Fallback	–
	IEC/EN 61131-2 conformity	–
	Protection	–
	Logic	–
Isolation	Between channels	Non-isolated
	Between channels and bus	1500 Vrms
	Between channels and ground	1500 Vrms
Sensor power supply (ripple included)	19...30 V	
Preactuator power supply (ripple included)	–	
Protection of inputs	Use a fast-blow fuse, max 0.5 A, depending on the module current load	
Output fuse protection	–	
Maximum dissipated power	3.57 W	
Conformal coated	Yes	
Operating temperature	-25...60 °C/-13...140 °F	
References	BMXSDI1602	

8-channel Safety discrete output module	4-channel Safety relay output module	4-channel Safety analog input module
		
		
		
DC	AC/DC relays	Current
24 V	24 V $\overline{\text{---}}$ /24...230 V \sim	–
0.5 A	5 A	–
–	–	6
–	–	4...20 mA
8	4 isolated outputs	4 isolated inputs
1		
–		
–		5 ms for the 4 inputs
–		16 bits (12,500 counts)
Via BMXFTB20●0 20-way caged, screw clamp, or spring-type removable terminal block		
–		
–		
–		Resistive
–		
Configurable fallback setting for each channel	–	
Yes		–
Yes		–
Positive	–	
Non-isolated	3000 Vrms	500 Vrms
1500 Vrms	3000 Vrms	1500 Vrms
1500 Vrms	3000 Vrms	1500 Vrms
–		
19...30 V	10...264 V \sim /10...34 V $\overline{\text{---}}$	–
–		
Use a fast-blow fuse, max 6 A, depending on the module current load	Use a fast-blow fuse, max 6 A, depending on the relay contact current load	–
4.40 W	3.90 W	3.98 W
Yes	Yes	Yes
-25...60 °C/-13...140 °F		
BMXSDO0802	BMXSRA0405	BMXSAI0410

Presentation

The Safety power supply in the Modicon X80 modules platform offer is the **BMXCPS●●●2S**.

The **BMXCPS4022S** Safety power supply:

- Converts 24...48 V $\overline{\text{---}}$ power into two output voltages, 24 V $\overline{\text{---}}$ and 3.3 V $\overline{\text{---}}$, which are distributed over the backplane
- Detects overvoltage, overload, and short-circuit conditions on both the 3.3 V $\overline{\text{---}}$ and 24 V $\overline{\text{---}}$ backplane lines

The **BMXCPS3522S** Safety power supply:

- Converts 100...150 V $\overline{\text{---}}$ power into two output voltages, 24 V $\overline{\text{---}}$ and 3.3 V $\overline{\text{---}}$, which are distributed over the backplane
- Detects overvoltage, overload, and short-circuit conditions on both the 3.3 V $\overline{\text{---}}$ and 24 V $\overline{\text{---}}$ backplane lines

The **BMXCPS4002S** Safety power supply:

- Converts 110...240 V \sim power into two output voltages, 24 V $\overline{\text{---}}$ and 3.3 V $\overline{\text{---}}$, which are distributed over the backplane
- Detects overvoltage, overload, and short-circuit conditions on both the 3.3 V $\overline{\text{---}}$ and 24 V $\overline{\text{---}}$ backplane lines, and allows a maximum voltage of 30 V $\overline{\text{---}}$

Description

The **BMXCPS●●●2S** Safety power supply includes:

- 1 Display panel comprising LEDs with various combinations to provide quick diagnostics of the power supply status:
 - ACTIVE LED (green): On when the power supply is the master power supply, off when it acts as a slave supply in a redundant application
 - OK LED (green): On if the rack voltages are present and correct
 - RD LED (green): On when all the internal power supplies function normally
- 2 Printed serial number and product version
- 3 Pencil-point Reset pushbutton for a cold restart of the application
- 4 2-way connector that can take a removable terminal block (caged or spring-type) for connecting the alarm relay
- 5 A 5-way connector that can take a removable terminal block (caged or spring-type) for connecting the following:
 - AC or DC line supply
 - Protective ground
- 6 1 hook and 1 screw for mechanical attachment and grounding connection to the backplane

Included with each power supply: Set of two caged removable terminal blocks (5-way and 2-way) **BMXXTSCPS10**

To be ordered separately (if necessary): Set of two spring-type removable terminal blocks (5-way and 2-way) **BMXXTSCPS20** (see [page 5/5](#)).

Compatibility of the power supply with the rack

The **BMXCPS●●●2S** is a safety-certified power supply that can be used as:

- a main local rack
- an extended local rack
- a main remote rack
- an extended remote rack

The **BMXCPS●●●2S** is a redundant power supply. It can be installed alone in single power supply rack or dual power supply rack as a pair (master and slave).

For high-availability applications, two independent redundant power supplies can be used to increase the security of the power supply. In case the master power supply fails to provide the whole current, the slave power supply changes to master mode and continues to function.

The power supply has to be inserted in the leftmost power supply slots on each rack (marked CPS).

Advanced diagnostics

The **BMXCPS●●●2S** can provide advanced diagnostics such as current load, temperatures, remaining life time, and undervoltage thresholds. These unique values will help to simplify maintenance by predicting when to replace the power supply before it fails.

Note: LED diagnostic display is provided for the module and for each input channel.

M1890_62018_CPSCT16005C

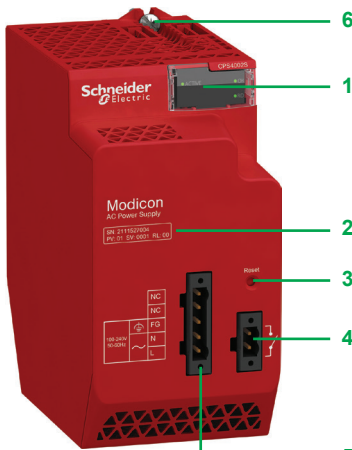

BMXCPS●●●2S

Functions

Alarm relay

The alarm relay incorporated in each power supply has a volt-free contact accessible on the front panel, on the 2-way connector.

The operating principle is as follows:

- The alarm relay is energized and its contact is closed (state 1) in normal operation, with the PLC in RUN.
- The relay de-energizes and its associated contact opens (state 0) whenever the application stops, even partially, due to any of the following:
 - Occurrence of a blocking fault (RAM detected error in memory check, Safety watchdog overrun detected on CPU, etc.)
 - Incorrect rack output voltages
 - Loss of supply voltage

Reset pushbutton

The power supply in each rack has a Reset button on the front panel.

Pressing the Reset button on the power supply causes re-initialization of all modules in the same rack as the power supply. If the **BMXCPS●●●2S** power supply is in the main local rack, pressing the Reset button causes re-initialization of the CPU.

In a redundant design, with two **BMXCPS●●●2S** power supplies, you can press the Reset button on either, or both, power supplies to execute the reset function.

Pressing this pushbutton triggers a sequence of service signals, which is the same as that for:

- A power break, when the pushbutton is pressed.
- A power-up, when the pushbutton is released

In terms of the application, these operations represent a cold start (forcing the I/O modules to state 0 and initializing the processor).

References

X80 Safety power supply (1)

Line supply	Available power (2)			Nominal current	Reference	Weight kg/lb
	3.3 V $\overline{\text{---}}$ (3)	24 V $\overline{\text{---}}$ rack (3)	Total			
24...48 V $\overline{\text{---}}$	18 W	40 W	40 W	1.67 A	BMXCPS4022S	0.810/ 1.786
100...150 V $\overline{\text{---}}$	180 W	40 W	40 W	1.67 A	BMXCPS3522S	0.610/ 1.345
100...240 V $\overline{\text{---}}$	18 W	40 W	40 W	1.67 A	BMXCPS4002S	0.510/ 1.124

Accessories for X80 Safety power supply

Description	Type	Composition	Reference	Weight kg/lb
Removable connectors	Spring-type	One 5-way terminal block and one 2-way terminal block	BMXXTSCPS20	0.015/ 0.033
	Caged	One 5-way terminal block and one 2-way terminal block	BMXXTSCPS10	0.020/ 0.044

(1) Include a set of 2 caged removable connectors. Spring-type connectors available separately under reference [BMXXTSCPS20](#).

(2) The sum of the power consumed on each voltage (3.3 V $\overline{\text{---}}$ and 24 V $\overline{\text{---}}$) must not exceed the total power of the module. See the power consumption table available on our website www.se.com.

(3) 3.3 V $\overline{\text{---}}$ and 24 V $\overline{\text{---}}$ rack voltages for powering modules in the Modicon X80 I/O rack.

M580_62098_SFSCT17005



Modicon M580 Safety configuration with a mix of standard X80 and Safety I/O

M580_62098_SFSCT17008



Modicon Safety configuration with Safety X80 modules only with removable terminal blocks

Presentation of Safety I/O modules

X80 is a powerful, proven solution for integrating an homogeneous automation architecture with a unique process and safety platform.

In the Modicon X80 offer, a Safety project can include both Safety modules and non-safety modules:

- Safety modules in the SAFE task
- Non-safety modules only for the non-safety tasks (MAST, FAST, AUX0, and AUX1)

Only non-safety modules that do not interfere with the safety function can be added to a Safety project.

Safety I/O modules can be used to connect the Safety PAC to sensors and actuators that are not part of the safety function loop.

Each Safety I/O module incorporates a dedicated Safety processor.

Safety I/O modules can be installed in the local backplane or in RIO drops.

All Safety I/O modules support SIL3 standards according to IEC 61508. The assessment is indicated by the category (Cat) and performance level (PL).

Each Safety I/O module provides module and channel LED diagnostics on the front face of the module:

- The top four LEDs (Run, Err, I/O, and Lck) indicate the module status.
- The bottom rows of LEDs combine with the top four LEDs to indicate the state and health of each input or output channel.

Presentation of Safety discrete I/O modules

There are three Safety discrete I/O modules in the Modicon X80 offer:

- **BMXSDI1602** Safety discrete input module
- **BMXSDO0802** Safety discrete output module
- **BMXSRA0405** Safety discrete relay output module

These modules can only be used with a Safety CPU.

BMXSDI1602

The **BMXSDI1602** Safety discrete input module has the following features:

- 16 Type 3 (1) inputs, in two groups of 8 non-isolated inputs
- 24 V $\overline{\text{---}}$ nominal input voltage
- Achieves SIL3, Cat2/PLd assessment using 1 input channel and Cat4/PLe using 2 input channels
- Compatible with 2- or 3-wire proximity sensors
- Optional provision of two 24 V $\overline{\text{---}}$ outputs (VS1 and VS2) for short-circuit to 24 V $\overline{\text{---}}$ monitoring
- Monitoring of external 24 V $\overline{\text{---}}$ sensor supply voltage

BMXSDO0802

The **BMXSDO0802** Safety discrete output module has the following features:

- 8 non-isolated 0.5 A outputs
- 24 V $\overline{\text{---}}$ nominal output voltage
- Achieves SIL3, Cat4/PLe assessment
- Monitoring of the external pre-actuator power supply

BMXSRA0405

The **BMXSRA0405** Safety discrete relay output module has the following features:

- 4 relay outputs with 5 A current
- 24 V $\overline{\text{---}}$ and 24...230 V \sim nominal output voltage (overvoltage category II)
- Achieves SIL2, Cat2/PLc assessment using 1 relay and SIL3, Cat4/PLe using 2 relays
- Support for 8 pre-defined application wiring configuration selections
- Configurable automatic self-test monitoring of the relay capacity to execute the commanded output state (depending on the selected application wiring configuration)
- Configurable module settings for fallback mode and fallback timeout (in ms)

(1) According to IEC61131-2 standard

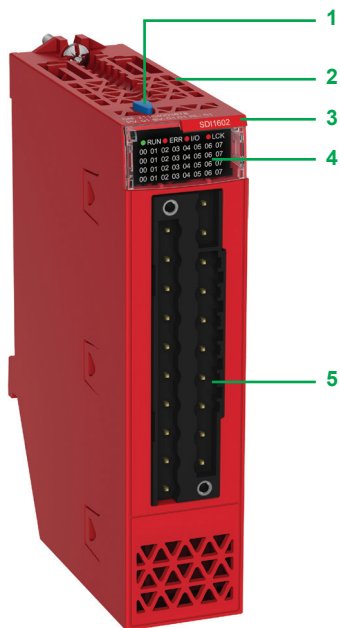

Safety discrete I/O module

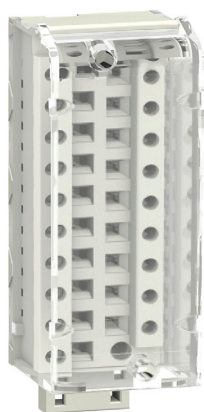

BMXFTB2000

Description

Safety discrete I/O modules are standard format with one slot. They have an IP20 housing to help protect the electronics, and are locked into position with a captive screw.

To be ordered separately: A **BMXFTB2000** 20-way removable terminal block (identification label supplied with each I/O module) or a preassembled cordset with a 20-way removable terminal block at one end and flying leads at the other (see connections on [page 5/7](#)):

BMXSDI1602, **BMXSDO0802**, and **BMXSRA0405**, Safety discrete modules include:

- 1 Lock/unlock configuration button
- 2 Rigid body providing support and protection for the electronic card
- 3 Module reference marking (a label is also visible on the right-hand side of the module)
- 4 Display panel comprising LEDs with various combinations to provide quick diagnostics of the status of the module and each channel:
 - RUN LED (green): module in operation
 - ERR LED (red): detected module error
 - I/O LED (red): detected I/O error
 - LCK LED (bi-color green/red): indicates the configuration status
 - 1 LED per channel (bi-color green/red): indicates the channel status
- 5 Connector taking the 20-way removable terminal block for connecting sensors or preactuators

Connections

20-way removable terminal blocks are used to connect the three Safety discrete I/O modules.

There are three types of 20-way removable terminal block:

- caged terminal block **BMXFTB2000** (1)
- screw clamp terminal block **BMXFTB2010** (1)
- spring-type terminal block **BMXFTB2020** (1)

Type of terminal block	Minimum capacity	Maximum capacity
Caged (1)	One 0.34 mm ² wire (AWG 22)	One 1 mm ² wire (AWG 18)
Screw clamp (1)	One or two 0.34 mm ² wires (AWG 22)	Two 1.5 mm ² wires (AWG 15)
Spring-type	One 0.34 mm ² wire (AWG 22)	One 1 mm ² wire (AWG 18)

(1) Connectors are equipped with captive screws: max. tightening torque 0.5 N.m/0.37 lb-ft.

Note: No cordset is provided for cabling Safety X80 I/O modules. Too many options are possible according to the kind of:

- application: safety only, safety mixed with availability, etc.
- functional safety level: SIL3/Cat2, SIL3/Cat4, SIL2, etc.

For more information on the different cabling options, please refer to the detailed user manuals published on our website: www.se.com.

M580_62038_CPSCT16001D



BMXSDI1602

M580_62038_CPSCT16002A



BMXSDO0802

M580_62038_CPSCT16004A



BMXSRA0405

5

References

X80 Safety discrete input module

Type of current	Input voltage	Connection via	IEC/EN 61131-2 conformity	Number of channels (common)	Reference	Weight kg/lb
DC	24 V (logic positive)	Caged, screw clamp, or spring-type 20-way removable terminal block	Type 3	16 non-isolated inputs (1 x 16)	BMXSDI1602	0.115/ 0.254

X80 Safety discrete output module

Type of current	Input voltage	Connection via	IEC/EN 61131-2 conformity	Number of channels (common)	Reference	Weight kg/lb
DC	24 V (logic positive)	Caged, screw clamp, or spring-type 20-way removable terminal block	Yes	8 non-isolated outputs (1 x 8)	BMXSDO0802	0.120/ 0.264

X80 Safety relay output module

Type of current	Input voltage	Connection via	IEC/EN 61131-2 conformity	Number of channels (common)	Reference	Weight kg/lb
AC/DC relay	24 V $\overline{=}$ / 24...230 V \sim	Caged, screw clamp, or spring-type 20-way removable terminal block	Yes	4 isolated outputs (1 x 4)	BMXSRA0405	0.145/ 0.320

Removable terminal blocks

Description	For use with modules	Type composition	Reference	Weight kg/lb
20-way removable terminal blocks	BMXSDI1602	Caged	BMXFTB2000	0.093/ 0.205
	BMXSDO0802	Screw clamp	BMXFTB2010	0.075/ 0.165
	BMXSRA0405	Spring	BMXFTB2020	0.062/ 0.132

M580_62098_CPSCT16001D

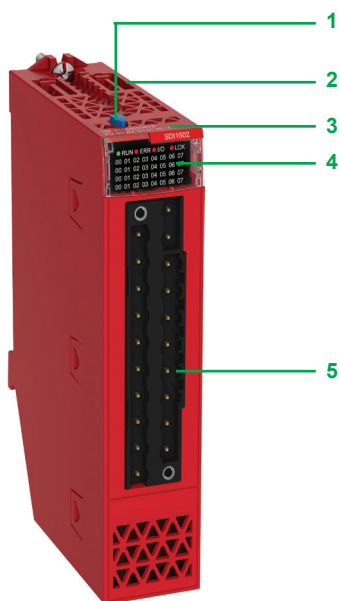

BMXSAI0410

Presentation

The Safety analog input module in the Modicon X80 offer is the **BMXSAI0410**:
The **BMXSAI0410** Safety analog input module has the following features:

- 4 isolated analog 4...20 mA current input channels
- 16-bit resolution (12,500 counts), spanning the data range 0...25 mA
- Current out of range detection, for current values less than 3.75 mA or greater than 20.75 mA
- Achieves SIL3, Cat2/PLd assessment using 1 input channel and SIL3, Cat4/PLe using 2 input channels

This module can only be used with a Safety CPU.

Description

The **BMXSAI0410** Safety analog input module includes:

- 1 Lock/unlock configuration button
- 2 Rigid body providing support and protection for the electronic card
- 3 Module reference marking (a label is also visible on the right-hand side of the module)
- 4 Display panel comprising LEDs with various combinations to provide quick diagnostics of the status of the module and each channel (1):
 - RUN LED (green): module in operation
 - ERR LED (red): detected module error
 - I/O LED (red): detected I/O error
 - LCK LED (bi-color green/red): indicates the configuration status
 - 1 LED per channel (bi-color green/red): indicates the channel status
- 5 Connector taking the 20-way removable terminal block for connecting sensors or preactuators

Connections

20-way removable terminal blocks are used to connect the analog input module. (2)

There are three types of 20-way removable terminal block:

- caged terminal block **BMXFTB2000** (3)
- screw clamp terminal block **BMXFTB2010** (3)
- spring-type terminal block **BMXFTB2020**

Type of terminal block	Minimum capacity	Maximum capacity
Caged (3)	One 0.34 mm ² wire (AWG 22)	One 1 mm ² wire (AWG 18)
Screw clamp (3)	One or two 0.34 mm ² wires (AWG 22)	Two 1.5 mm ² wires (AWG 15)
Spring-type	One 0.34 mm ² wire (AWG 22)	One 1 mm ² wire (AWG 18)

Red labels are provided for Safety I/O modules.

References

X80 Safety analog input modules

Type of input	Input signal range	Resolution	Connection	Nb of channels	Reference	Weight kg/lb
Isolated high-level input	4–20 mA	16 bits	Removable terminal block, 20-way caged, screw clamp, or spring-type	4	BMXSAI0410	0.143/ 0.315

Connection accessories for X80 Safety analog input module

Description	For use with modules	Type composition	Reference	Weight kg/lb
20-way removable terminal blocks	BMXSAI0410	Caged	BMXFTB2000	0.093/ 0.205
		Screw clamp	BMXFTB2010	0.075/ 0.165
		Spring	BMXFTB2020	0.060/ 0.132

(1) LEDs in positions 5...7 are not used because the input module only has four channels.

(2) No cordset is provided for cabling safety X80 I/O modules. Too many options are possible according to the kind of:

- applications: safety only, safety mixed with availability, etc.
- functional safety level: SIL3/Cat2, SIL3/Cat4, SIL2, etc.

For more information on the different cabling options, please refer to the detailed user manuals published on our website: www.se.com.

(3) Connectors are equipped with captive screws: max. tightening torque 0.5 N.m/0.37 lb-ft.

M580_62098_OPEJFR17001A



SDI1602 red label

PF108141D

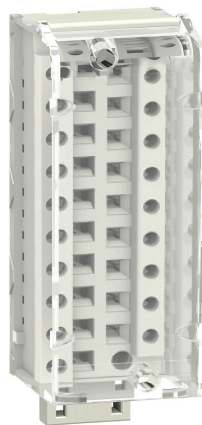

BMXFTB2000

X80 Counter modules

- Presentation, description [page 6/2](#)
- Functions [page 6/3](#)
- References [page 6/5](#)

X80 Time-stamping module

- Presentation, description [page 6/6](#)
- Performance, references [page 6/7](#)

X80 SSI encoder interface module

- Presentation, description [page 6/8](#)
- Functions, references [page 6/9](#)

X80 Motion control module

- Presentation, description [page 6/10](#)
- Operation, references [page 6/11](#)
- MFB library presentation, functions [page 6/12](#)
- Motion tree manager, programming, maintenance [page 6/13](#)

X80 Frequency input module

- Presentation, description [page 6/14](#)
- Module specifications, references [page 6/15](#)

X80 Weighing module

- Presentation, description [page 6/16](#)
- References [page 6/17](#)

Presentation

BMXEHC0200 and **BMXEHC0800** counter modules for the Modicon X80 modules platform are used to count the pulses generated by a sensor or to process the signals from an incremental encoder.

The two modules differ in their number of counter channels, maximum input frequencies, functions, and auxiliary input and output interfaces:

Counter module	No. of channels	Maximum frequency	Integrated functions	No. of physical inputs	No. of physical outputs
BMXEHC0200	2	60 KHz	Upcounting Downcounting Period meter Frequency meter Frequency generator Axis control	6	2
BMXEHC0800	8	10 KHz	Upcounting Downcounting Measurement	2	–

The sensors used on each channel can be:

- 2-wire 24 V proximity sensors
- 3-wire 24 V proximity sensors
- 10/30 V output signal incremental encoders with push-pull outputs

BMXEHC0200/0800 counter modules can be used to meet the demands of applications such as:

- Alarm generation on empty unwinder status using the ratio
- Sorting small parts using the period meter
- Single electronic cam using the dynamic setting thresholds
- Speed control using the period meter

These standard format modules can be installed in any available slot on a Modicon X80 platform. They are hot-swappable.

In a Modicon X80 PLC configuration, the number of **BMXEHC0200/0800** counter modules should be added to the number of application-specific modules (communication). The function parameters are set by configuration using EcoStruxure Control Expert (1) software.

Description

BMXEHC0200/0800 counter modules are standard format. They occupy a single slot in **BM●XBP●●●** racks. They come in a plastic case, which provides IP20 protection of the electronics, and are locked into position by a captive screw.

BMXEHC0200 module, 2 channels, 60 KHz

The front panel of the **BMXEHC0200** counter module features:

- 1 Module and channel status display block
- 2 16-way connector for connecting the sensors of counter 0
- 3 16-way connector for connecting the sensors of counter 1
- 4 10-way connector for connecting:
 - Auxiliary outputs
 - Sensor power supplies

To be ordered separately:

- A **BMXXTSHSC20** kit containing two 16-way connectors and one 10-way connector (see [page 6/5](#))
- A **BMXXSP●●00** shielding connection kit if the rack is not already equipped with one (see [page 2/5](#))

BMXEHC0800 module, 8 channels, 10 KHz

The front panel of the **BMXEHC0800** counter module features:

- 1 Module and channel status display block
- 2 Connector taking the **BMXFTB20●0** 20-way removable terminal block 3 (same as that of I/O modules)

To be ordered separately:

- A 20-way removable terminal block 3 (caged, screw clamp, or spring-type) (see [page 4/13](#))
- A **BMXXSP●●00** shielding connection kit if the rack is not already equipped with one (see [page 2/5](#))

(1) EcoStruxure Control Expert software continues the Unity Pro range of software and corresponds to versions ≥ 14 of Unity Pro.



EcoStruxure Control Expert monitor

6

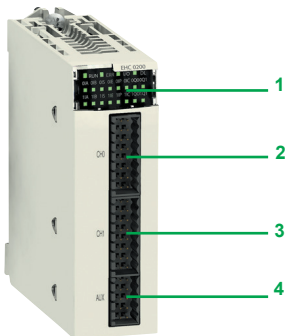

BMXEHC0200

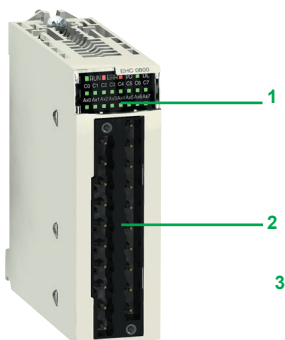

BMXEHC0800

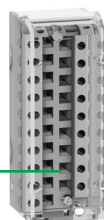

BMXFTB20●0

Operating modes for module BMXEHC0200

8 configurable modes	
Frequency meter	<p>This mode measures a frequency, speed, data rate, or an event stream. As standard, this mode measures the frequency received on the IN_A input. This frequency is expressed in Hz (number of pulses/second), with a precision of 1 Hz.</p> <p>The maximum frequency on the IN_A input is 60 kHz. The maximum cyclic ratio at 60 kHz is 60%.</p>
Event counting	<p>This mode is used to determine the number of events received. In this mode, the counter calculates the number of pulses applied to the IN_A input at time intervals defined by the user.</p> <p>The module counts the pulses applied to the IN_A input each time the pulse for this input lasts longer than 5 μs (without anti-bounce filter).</p>
Period measurement	<p>This mode is used to:</p> <ul style="list-style-type: none"> ■ Determine the duration of an event ■ Determine the time between 2 events ■ Time and measure the execution time of a process <p>It measures the time elapsed during an event or between 2 events (IN_A input) according to a selectable time base of 1 μs, 100 μs, or 1 ms. The IN_SYNC input can be used to enable or stop a measurement. The module can carry out a maximum of 1 measurement every 5 ms. The shortest measurable pulse is 100 μs, even if the unit defined by the user is 1 μs. The maximum measurable duration is 4,294,967,295 units (unit to be defined).</p>
Ratio counting	<p>Ratio counting mode only uses the IN_A and IN_B inputs. There are 2 possible modes:</p> <ul style="list-style-type: none"> ■ Ratio 1: Used to divide 2 frequencies. This is intended for applications such as flowmeters, mixers, etc. ■ Ratio 2: Used to subtract 2 frequencies. This is intended for the same applications, but for those requiring more precise regulation (more similar frequencies). <p>Ratio 1 mode gives the results in thousandths for better accuracy (a display of 2,000 corresponds to a value of 2) and ratio 2 mode gives the results in Hz.</p> <p>The maximum frequency that the module can measure on the IN_A and IN_B inputs is 60 kHz.</p>
Downcounting	<p>This mode is used to list a group of operations. In this mode, activating the synchronization function starts the counter which, starting from a user-defined preset value, decreases with each pulse applied to the IN_A input, until it reaches 0. This downcounting is made possible when the enable function has been activated. The counting register is thus updated at 1 ms intervals.</p> <p>One basic use of this mode is to signal, using an output, the end of a group of operations (when the counter reaches 0).</p> <p>The shortest pulse applied to the IN_SYNC input is 100 μs. The maximum frequency applied to the IN_SYNC input is 1 pulse every 5 ms. The maximum user-defined preset value is 4,294,967,295. The maximum count value is 4,294,967,295 units.</p>
Loop (modulo) counting	<p>This mode is used in packaging and labeling applications where actions are repeated on sets of moving objects:</p> <ul style="list-style-type: none"> ■ In upcounting, the counter increases until it reaches the user-defined "modulo - 1" value. On the next pulse, the counter is reset to 0 and upcounting restarts. ■ In downcounting, the counter decreases until it reaches 0. On the next pulse, the counter is reset to the user-defined "modulo - 1" value. Downcounting can then restart. <p>The maximum frequency applied to the IN_A and IN_B inputs is 60 kHz. The maximum frequency of the modulo event is 1 event every 5 ms. The maximum modulo value is 4,294,967,296 (possible by declaring 0 in the modulo adjust value).</p>
32-bit counter counting	<p>This mode is mainly used in axis following.</p> <p>The maximum frequency applied simultaneously to the IN_A and IN_B inputs is 60 kHz. The maximum frequency of the referencing event is 1 event every 5 ms. The counter value is between -2,147,483,648 and +2,147,483,647.</p>
Width modulation	<p>In this operating mode, the module uses an internal clock generator to supply a periodic signal on the module's O0 output. Only the O0 output is affected by this mode, as the O1 output is independent of it.</p> <p>The maximum output frequency is 4 kHz. As O0 is a source output, a load resistor is necessary for the O0 output signal to change to 0 at the correct frequency. The cyclic ratio adjustment range varies according to the frequency of the O0 output.</p>

Operating modes for module BMXEHC0800

5 configurable 16-bit modes	Frequency meter	<p>This mode measures a frequency, speed, rate, or data stream control. As standard, this mode measures the frequency received on the IN A input. This frequency is expressed in Hz (number of pulses per second), with a precision of 1 Hz.</p> <p>The maximum frequency on the IN A input is 10 kHz. The maximum cyclic ratio at 10 kHz is 60%.</p>
	Event counting	<p>This mode is used to determine the number of events received. In this mode, the counter calculates the number of pulses applied to the IN_A input at time intervals defined by the user. As an option, it is possible to use the IN_AUX input during a period of time, provided that the enable bit has been configured.</p> <p>The module counts the pulses applied to the IN_A input each time the pulse for this input lasts longer than 50 μs (without anti-bounce filter). Pulses with less than 100 ms synchronization are lost.</p>
	Downcounting	<p>This mode is used to list a group of operations. In this mode, when counting is enabled (software validation via the valid_sync command), a rising or falling edge on the IN_AUX input causes a value, defined by the user, to be loaded in the counter. The latter decreases with each pulse applied to the IN_A input until it reaches the value 0. Downcounting is made possible when the force_enable command is high (software positioning).</p> <p>The smallest pulse applied to the IN_AUX input varies according to the selected filter level. The maximum frequency applied to the IN_AUX input is 1 pulse every 25 ms.</p>
	Loop (modulo) counting	<p>This mode is used in packaging and labeling applications where actions are repeated on sets of moving objects. The counter increases with each pulse applied to the IN_A input until it reaches the user-defined "modulo - 1" value. On the next pulse in the upcounting direction, the counter is reset to 0 and upcounting restarts.</p> <p>The maximum frequency applied to the IN_A input is 10 kHz. The smallest pulse applied to the IN_AUX input varies according to the selected filter level. The maximum frequency of the modulo event is 1 event every 25 ms. The maximum modulo value is 65,536 units.</p>
	Up/down counter	<p>This mode is used for an accumulation, upcounting, or downcounting operation on a single input. Each pulse applied to the IN_A input produces:</p> <ul style="list-style-type: none"> ■ Upcounting of pulses if the IN_AUX input is high ■ Downcounting of pulses if the IN_AUX input is low <p>The counter values vary between the limits -65,536 and +65,535. The maximum frequency applied to the IN_A input is 10 kHz. Pulses applied to the IN_A input after a change of direction are only upcounted or downcounted after a period corresponding to the delay for taking account of the state of the IN_AUX input due to the programmable filter level on this input.</p>
One 32-bit mode	32-bit counter counting	<p>32-bit counter counting mode is available for channels 0, 2, 4, and 6 (channels 1, 3, 5, and 7 are now inactive). It behaves in the same way as the up/down counting mode using up to 3 physical inputs. It enables simultaneous upcounting and downcounting.</p> <p>The counter values vary between the limits -2,147,483,648 and +2,147,483,647 (31 bits + sign). The maximum frequency applied to the IN_A and IN_B inputs is 10 kHz. The smallest pulse applied to the IN_AUX input is defined according to the filtering applied to this input. The maximum frequency of loading the preset value is 1 every 25 ms.</p>



BMXEHC0200



BMXEHC0800

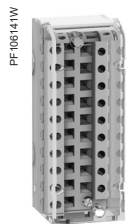

BMXFTB2000

References

X80 counter modules (1)

Description	No. of channels	Characteristics	Reference	Weight kg/lb
Counter modules for 24 V ---	2	60 kHz counting	BMXEHC0200	0.112/ 0.247
2 and 3-wire sensors and 10/30 V --- incremental encoders with push-pull outputs	8	10 kHz counting	BMXEHC0800	0.113/ 0.249

Connection accessories (2)

Description	Composition	Unit reference	Weight kg/lb
Pack of connectors for BMXEHC0200 module	Two 16-way connectors and one 10-way connector	BMXXTSHSC20	0.021/ 0.046
20-way removable terminal blocks for BMXEHC0800 module	Caged	BMXFTB2000	0.093/ 0.205
	Screw clamp	BMXFTB2010	0.075/ 0.165
	Spring	BMXFTB2020	0.060/ 0.132

Shielding connection kit Comprising a metal bar and two support bases for mounting on rack for X80 counter modules See [page 2/5](#) -

(1) Typical consumption: See the power consumption table available on our website www.se.com.

(2) The shielding on the cordsets carrying the counter signals must always be connected to the **BMXXSP0000** shielding connection kit mounted under the rack that holds the **BMXEHC0200** module (see [page 2/3](#)).



BMXERT1604T/BMXERT1604H

Presentation

The **BMXERT1604T/H** time-stamping module is a complete solution providing a SCADA with a sequence of events that are time-stamped at source, enabling the user to analyze the source of any abnormal behavior in an automated system.

The SOE (sequence of events) is displayed in the alarms log or in the list of events for a client such as a SCADA.

Each event in the SOE is a change of value (transition) of a discrete I/O detected by a time-stamping module.

Advantages

Using the time-stamping system has the following advantages:

- No PLC programming
- Direct communication between the time-stamping modules and the client; if the time-stamping modules are in a Quantum Ethernet I/O drop, the bandwidth of the PLC communication is not used
- Consistency of the I/O values between the process (time-stamping modules) and the client
- Consistency is maintained irrespective of the operating mode
- No loss of events under normal operating conditions
- Management of Hot Standby configurations on the PLC and/or SCADA redundancy

Composition of a time-stamping architecture

X80 Remote I/O drop adapter

The **BMXERT1604T/H** module can be at the source of any discrete I/O signal located in the drop with a resolution of 10 ms. To help ensure no event is lost, all events are stored and kept in a buffer located in the product until OFS takes them.

The NTP protocol is used to synchronize the X80 Remote I/O drop adapter (BM●CRA312●0).

X80 Time-stamping module

The **BMXERT1604T/H** time-stamping module has 16 discrete inputs which carry out the time-stamping at source outputs with a resolution of 1 ms.

To help ensure no event is lost, all events are stored and kept in a buffer located in the product until OFS takes them.

This module can be placed either in an RIO drop, or in a local rack equipped with a X80 Remote I/O drop adapter which is synchronized via the DCF 77 or IRIG-B standards.

OFS V3.60 software

OFS V3.60 software is used to access events stored in the various buffers in the architecture and to place them in the SCADA via the standard OPC DA protocol. For further information, consult our website www.se.com.

AVEVA Plant SCADA

AVEVA Plant SCADA receives events transmitted by OFS and displays them in the SOE or in the list of alarms. For further information, consult our TPP partner website www.se.com/en/partners/technology-partners/.



Performance

Performance	Event source module	Value
Between two identical source modules in the same rack	BMXERT1604T	1.6 < resolution < 3.3 ms
	BMXERT1604H	
	BM●CRA31210	10 ms
Between two different inputs in the same source module	BMXERT1604T	1 ms
	BMXERT1604H	
	BM●CRA31210	1 scan
Maximum buffer	BMXERT1604T BMXERT1604H	255 groups (1)
Maximum number of discrete inputs/outputs monitored by the PLC for the entire time-stamping module	BMXERT1604T	400 discrete inputs (2)
	BMXERT1604H	
	BM●CRA31210	2,048 discrete I/Os (2)
Maximum number of I/O and memory available	BMXERT1604T	16 discrete inputs on module
	BMXERT1604H	255 groups (3)
	BM●CRA31210	256 discrete I/O configured 4,000 events in internal buffer
Maximum number of source modules in an Ethernet remote drop	BM●CRA31210	1 per drop
	BMXERT1604T	9 per drop
	BMXERT1604H	
Maximum number of sources of events polled by OFS	BMXERT1604T BMXERT1604H	500 sources per second (2)

References

X80 Time-stamping modules

Description	Input type	Reference	Weight kg/lb
Multifunction time-stamping input module	16 discrete inputs	BMXERT1604T	0.119/ 0.262
Multifunction time-stamping input module for severe environments		BMXERT1604H	

Connection accessories for time-stamping modules

Description	For use with modules	Type, composition	Length	Reference	Weight kg/lb
28-way removable terminal blocks	BMXERT1604T BMXERT1604H	Caged	–	BMXFTB2800	0.111/ 0.245
		Spring	–	BMXFTB2820	0.080/ 0.176

(1) A group is a set of 1 to 16 events detected in the same cycle.

(2) This maximum value is not an absolute value. It depends on the overall system dynamics (total number of scanned items and number of events generated by the system).

(3) The event number contained in one group varies within 1..16. It depends on how many channels get the events occurred within same sampling window (0.5ms).

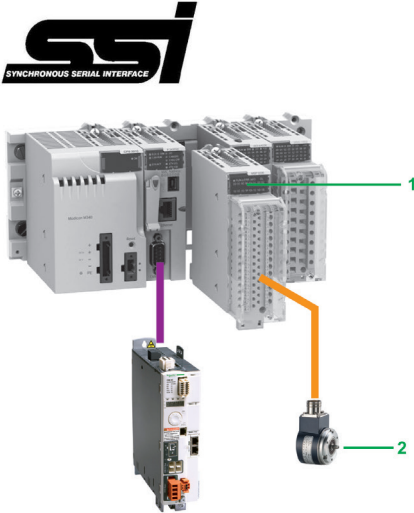

Modicon X80 modules platform with Modicon M340 processor

Presentation

The **BMXEAE0300** SSI encoder interface module **1** for the Modicon automation platform (1) is a 3-channel standard synchronous serial interface module designed for use with SSI absolute encoders **2**.

The **BMXEAE0300** module enables SSI encoder values to be processed on PAC platforms for applications requiring accurate position/angular control, such as:

- Hydro power, e.g. dam inlet gate position control
- Wind power, e.g. wind turbine blade pitch control
- Complex motion loop control, e.g. ship elevator, blast furnace, flame cutting, etc.

The **BMXEAE0300** module provides a migration path from Premium (with **TSXCTY2C** measurement and counter module) to the Modicon X80 modules platform SSI solution to compete in the above market segments.

Like any other application-specific module, the **BMXEAE0300** module is installed in the rack slots (01 to 11). The number of modules is limited by the maximum number of application-specific channels permitted according to the CPU type (consult our website www.se.com).

Dam inlet gate control

Inlet gate control enables the water level in a dam to be monitored and controlled:

- The SSI encoder provides the PLC with accurate feedback of the gate position for precise monitoring of gate opening, adjustment, and positioning.
- The SSI interface converts the signals from the SSI encoders and transmits them to the CPU.

Wind turbine blade pitch control

Pitch control is required for adjusting the angle of the wind turbine blades in relation to the wind direction and strength, in order to achieve optimum energy conversion efficiency.

- The SSI absolute encoder is frequently used to feed back the position of the blade due to its reliability and robustness.
- Typically, the position of each of the three blades is read by the SSI encoders and then transmitted to the CPU via the SSI interface for motion loop control. Sometimes, 3 additional SSI inputs act as backup. Therefore, this new offer is adequately sized for the channel density.

Description

The **BMXEAE0300** SSI encoder interface module is standard format (1 slot). Its housing provides IP20 protection of the electronics and it is locked in each slot (**01** to **11**) by a captive screw.

The front panel of the **BMXEAE0300** module features:

- 1** A rigid housing providing support and protection for the electronic card
- 2** The module reference marking (a label is also visible on the right-hand side of the module)
- 3** A display block indicating:
 - Module status via 4 LEDs:
 - RUN (green): module operating status
 - ERR (red): internal fault detected in the module or a fault detected between the module and the rest of the configuration
 - I/O (red): external fault detected
 - DL (green): firmware download status
 - Status of the 3 SSI channels via 8 LEDs:
 - Sx (green): channel x input (x = 0, 1, or 2)
 - Qx (green): reflex output for channel x (x = 0, 1, or 2)
 - IO/1 (green): capture inputs for the 3 SSI channels
- 4** A connector for a 28-way terminal block, for connecting to a removable caged or spring terminal block on sensors and preactuators

To be ordered separately:

- 5** A **BMXFTB2800** 28-way removable caged terminal block or **BMXFTB2820** spring terminal block, supplied with a channel identification label (see [page 6/11](#))
 - A shielding connection kit to help protect against electrostatic discharge, consisting of a metal bar and two sub-bases for mounting on the rack: **BMXXSP●●00** (reference dependent on the number of slots in the rack) (see [page 2/5](#))
 - A set of clamping rings **STBXSP30●0** for the connection cable shielding braids (reference dependent on the cable diameter) (see [page 2/5](#))

(1) Only for the Modicon automation platforms compatible with Modicon X80 modules platform

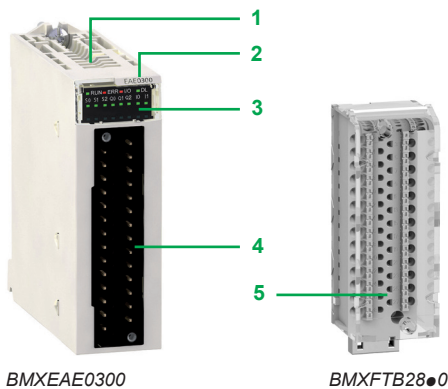

BMXEAE0300

BMXFTB2800

Module specifications and functions

Specifications

The **BMXEAE0300** SSI encoder interface module is a 3-channel, synchronous serial interface, absolute encoder interface for Modicon PLCs. It supports:

- 3 channels of SSI inputs (DATA pair, CLK pair, 24 VDC field power supply to encoder)
- 1 reflex output for each SSI channel (Q)
- 2 capture inputs for the 3 SSI channels (CAP_IN0, CAP_IN1)
- 8 to 31 bits data width
- 4 baud rates (100 kHz, 200 kHz, 500 kHz, and 1 MHz)
- Capture and compare functions

Basic and optional functions

The following table presents the main functions of the **BMXEAE0300** module:

Function	Basic/ optional	Description
Absolute SSI encoder value acquisition	Basic	The position values of the SSI channel are automatically read by the module within 1 ms, unless the channel is disabled.
Modulo	Optional for motion	The modulo function limits the dynamics of the position value to within the power of 2. An event (if enabled) detects the passing of the modulo. The reflex output can also be detected when the modulo is passed (if configured).
Reduction	Optional for motion	This function reduces the intrinsic resolution of the encoder by a value defined by the "reduction" parameter. This reduction is carried out by a shift in the bit field provided by the encoder.
Offset	Optional for motion	The correction function of the encoder offset systematically corrects the offset produced by the encoder at mechanical position "0". The user enters the absolute encoder offset parameter.
Capture	Optional for events	The two capture input registers (per channel) enable the PLC program to carry out a dynamic measurement function between two points. The capture action can be triggered by two capture inputs. The event will be triggered at each capture.
Compare	Optional for events	Two independent comparators (per channel), with thresholds that can be modified by adjustment (explicit exchange), are able to generate an event or reflex output when the threshold is crossed.



EcoStruxure Control Expert monitor



BMXEAE0300

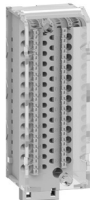

BMXFTB28-0

Main features

- Supported by EcoStruxure Control Expert (1).
- Supports absolute encoder 24 V model with standard SSI interface, including Telemecanique Sensors OsiSense SSI encoders. For further information, consult the website www.tesensors.com.
- Standards and approvals: CE, UL, CSA, C-Tick, GOST, etc.

References

X80 SSI encoder interface module (2)

Description	Number of channels	Description per channel	Reference	Weight kg/lb
SSI encoder interface module	3 SSI channels	1 reflex output for each SSI channel	BMXEAE0300	0.138/
		2 capture inputs for the 3 SSI channels 8 to 31 bits data width 4 baud rates: 100 kHz, 200 kHz, 500 kHz, 1 MHz Capture and compare functions		0.304

Cabling accessories

Description	Description, use	Reference	Weight kg/lb
28-way removable terminal block	Caged	BMXFTB2800	0.111/ 0.245
	Spring	BMXFTB2820	0.080/ 0.176
Shielding connection kit for BMXEAE0300 module (3)	Comprising a metal bar and two support bases for mounting on rack	See page 2/5	–

(1) EcoStruxure Control Expert software continues the range of Unity Pro software and corresponds to versions ≥ 14 of Unity Pro.

(2) Typical consumption: See the power consumption table available on our website www.se.com.

(3) The shielding on the cables carrying the power supply to the module, each SSI channel, the capture inputs, and the reflex outputs (if any of them is wired) must always be connected to the **BMXXSP-000** shielding connection kit mounted under the rack holding the **BMXEAE0300** module (see [page 2/3](#)).

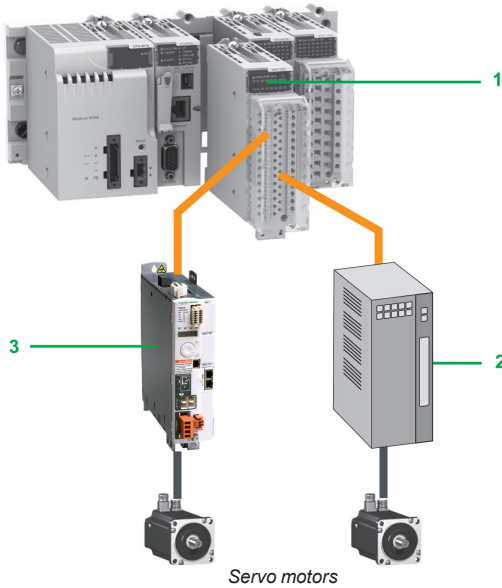

Servo motors

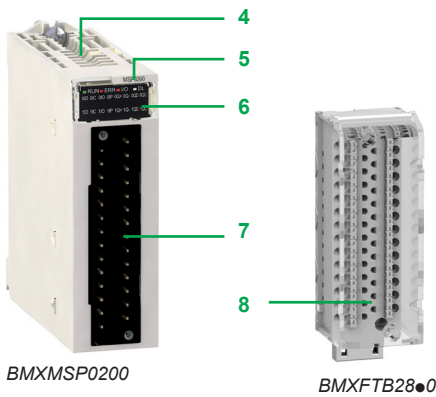

BMXMSP0200

BMXFTB2800



DIA6ED2151012EN

Presentation

The **1 BMXMSP0200** motion control pulse train output (PTO) module for the Modicon X80 modules platform is used for controlling third-party variable speed drives **2**, which have an integrated position loop and inputs that are compatible with open collector outputs.

The **BMXMSP0200** Motion control module is also directly compatible with the Lexium 32C and 32M **3** servo drive ranges, which have an integrated pulse control interface.

The **BMXMSP0200** motion control PTO module has two independent PTO channels. Like any other application-specific module, it is installed in the rack slots (labeled **01** to **11**). The number of modules is limited by the maximum number of application-specific channels permitted according to the CPU type:

- Standard **BMXP341000**: Maximum of 20 application-specific channels (1)
- Performance **BMXP342000**: Maximum of 36 application-specific channels (1)
- **BMEP5810**: Maximum of 24 application-specific channels (1)
- **BMEP5820**: Maximum of 32 application-specific channels (1)
- **BMEP5830** and **BMEP5840**: Maximum of 64 application-specific channels (1)
- **BMEP585040**: Maximum of 180 application-specific channels (1)
- **BMEP586040**: Maximum of 216 application-specific channels (1)

Description

The **BMXMSP0200** motion control module is standard format (1 slot). Its housing provides IP20 protection of the electronics and it is locked in each slot (**01** to **11**) by a captive screw.

The front panel of the **BMXMSP0200** motion control module features:

- 4** A rigid body providing support and protection for the electronic card
- 5** A module reference marking (a label is also visible on the right-hand side of the module)
- 6** A display block indicating:
 - Module status via 4 LEDs (RUN, ERR, I/O, and DL)
 - Status of the auxiliary inputs, 4 per channel
 - Status of the PTO outputs, 2 per channel
 - Status of the auxiliary outputs, 2 per channel
- 7** A connector for a 28-way terminal block, for connecting to a removable spring terminal block on sensors and preactuators

To be ordered separately:

- 8** A **BMXFTB2800** 28-way removable caged terminal block or **BMXFTB2820** spring terminal block, supplied with a channel identification label (see [page 6/11](#))
 - A shielding connection kit to help protect against electrostatic discharge, consisting of a metal bar and two sub-bases for mounting on the rack: **BMXXSP0000** (reference dependent on the number of slots in the rack) (see [page 2/5](#))
 - A set of clamping rings **STBXSP3000** for the connection cable shielding braids (reference dependent on the cable diameter) (see [page 2/5](#))

(1) Application-specific channels: **BMXEHC0200** (2-channel) and **BMXEHC0800** (8-channel) counter modules, **BMXMSP0200** (2-channel) motion control module, **BMXNOM0200** (2-channel) and **BMXNOR0200H** (1-channel) serial communication modules, **BMEAHI0812** (8-channel) analog input module and **BMEAHO0412** (4-channel) analog output module, **BMXAE0300** (3-channel) SSI module and **BMXERT1604T/H** (16-channel) discrete input module.

Operation

Block diagram of a BMXMSP0200 module channel

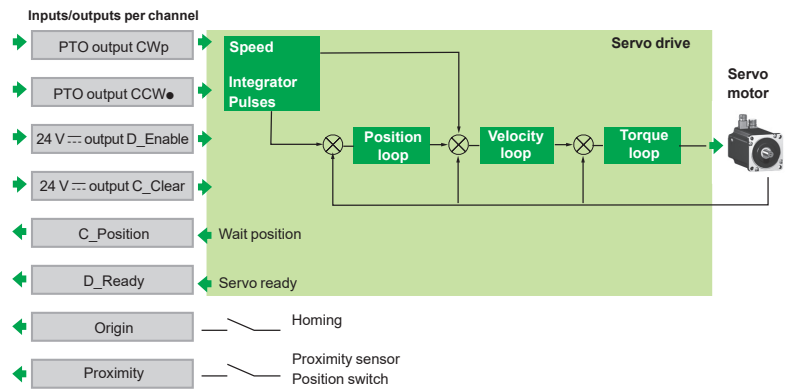

BMXMSP0200



BMXFTB2800

References

X80 Motion control module (1)

Description	Number of channels	Description per channel	Reference	Weight kg/lb
PTO module	2	2 x 200 kHz max. PTO outputs 2 x 24 V \pm 50 mA auxiliary outputs 4 x 24 V \pm auxiliary inputs	BMXMSP0200	0.145/ 0.320

Cabling accessories

Description	Description, use	Length	Reference	Weight kg/lb
28-way removable terminal block	Caged Spring	–	BMXFTB2800 BMXFTB2820	0.111/ 0.245 0.080/ 0.176

Connection cable for daisy chain or pulse control (2)	From BMXMSP0200 (screw clamp terminal block) module to Lexium 32C or 32M (RJ45 connector) (cable with flying leads at one end and an RJ45 connector at the other)	3 m/9.84 ft	VW3M8223R30	–
Shielding connection kit for module BMXMSP0200	Comprising a metal bar and two support bases for mounting on rack	–	See page 2/5	–

(1) Typical consumption: See the power consumption table available on our website www.se.com.

(2) The shielding on the cordsets carrying the motion control signals must always be connected to the [BMXXSP●●00](#) shielding connection kit mounted under the rack holding the [BMXMSP0200](#) module (see [page 2/3](#)).

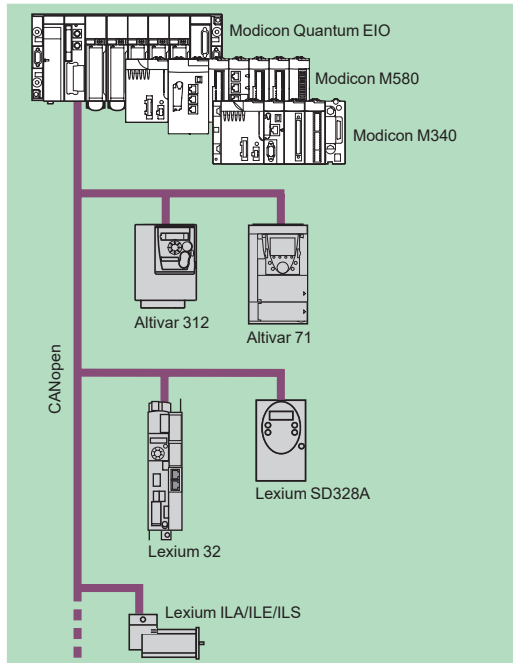

MFB: Motion control distributed over CANopen



Presentation

MFB (Motion Function Blocks) is a library of function blocks integrated in EcoStruxure Control Expert (1) used to set up motion control in the architectures of drives and servo drives on CANopen buses:

- Altivar 312: For asynchronous motors from 0.18 to 15 kW/0.25 to 20 HP
- Altivar 71: For synchronous or asynchronous motors from 0.37 to 500 kW/0.5 to 700 HP
- Lexium 32: For servo motors from 0.15 to 7 kW/0.20 to 10 HP
- Lexium ILA/ILE/ILS: Integrated motor drives from 0.10 to 0.35 kW/0.13 to 0.47 HP
- Lexium SD328A: For 3-phase stepper motors from 0.35 to 0.75 kW/0.47 to 1 HP

In compliance with PLCopen specifications, the MFB library allows both easy and flexible motion programming with EcoStruxure Control Expert (1), as well as axis diagnosis.

In maintenance operations, drives can be replaced quickly thanks to drive parameter download blocks.

Setting up drives on the CANopen network is facilitated through Motion Tree Manager organization in the EcoStruxure Control Expert (1) browser, making it easy for users to access the application drives.

Applications

The features of the Motion Function Blocks library are particularly suitable for machines with independent axes. In the case of these modular/special machines, MFB function blocks are an ideal solution for controlling single axes. The following are typical applications for this type of architecture:

- Automatic storage/removal
- Material handling
- Palletizers/depalletizers
- Conveyors
- Packaging, simple labeling application
- Grouping/ungrouping
- Adjustment axes in flexible machines, etc.

Functions

The table below lists the function blocks of the MFB library and the compatible drives. The prefix indicates the block family:

- MC: Function block defined by the Motion Function Blocks PLC Open standard
- TE: Function block specific to Schneider Electric products
- Lxm: Function block specific to Lexium servo drives

Type	Function	Function block	Altivar 312	Altivar 71	Lexium 32	Lexium ILA/ILE/ILS	Lexium SD328A
Management and motion	Read an internal parameter	MC_ReadParameter					
	Write an internal parameter	MC_WriteParameter					
	Read the current position	MC_ReadActualPosition					
	Read the instantaneous speed	MC_ReadActualVelocity					
	Acknowledge detected error messages	MC_Reset					
	Stop any active movement	MC_Stop					
	Axis coming to standstill	MC_Power					
	Movement to absolute position	MC_MoveAbsolute					
	Relative movement	MC_MoveRelative					
	Additional movement	MC_MoveAdditive					
	Homing	MC_Home					
	Movement at given speed	MC_MoveVelocity					
	Read diagnostic data	MC_ReadAxisError					
	Read servo drive status	MC_ReadStatus					
	Torque control	MC_TorqueControl					
	Read actual torque value	MC_ReadActualTorque					
Manual control	MC_Jog						
Save and restore parameters (FDR)	Read drive parameters and store in PLC memory	TE_UploadDriveParam					
	Write drive parameters from PLC memory	TE_DownloadDriveParam					
Advanced Lexium functions	Read a motion task	Lxm_UploadMTask					
	Write a motion task	Lxm_DownloadMTask					
	Start a motion task	Lxm_StartMTask			(1)		
	Set the reduction ratio, signed	Lxm_GearPosS			(1)		
System	Communication with the servo drive	TE_CAN_Handler					

Compatible

(1) The Lxm_StartMTask and Lxm_GearPosS function blocks are only compatible with Lexium 32 (LXM32M) servo drives.

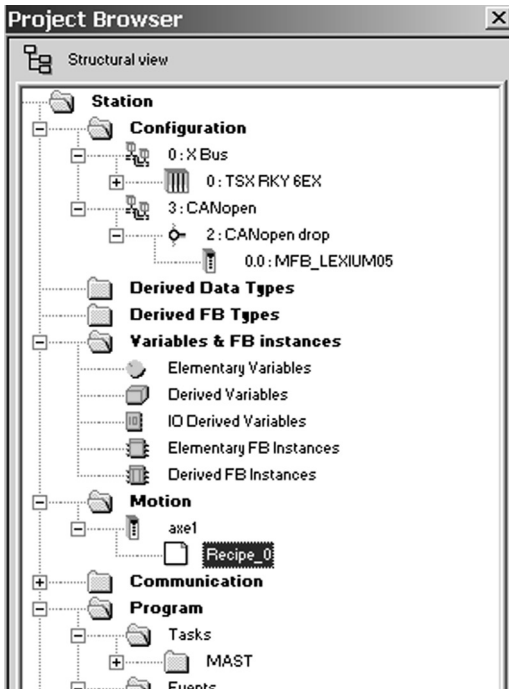

Motion Tree Manager integrated in the EcoStruxure Control Expert browser

Motion Tree Manager

Motion Tree Manager is associated with MFB library of EcoStruxure Control Expert (1) and integrated in its browser. It provides specific assistance for:

- Axis object management
- Axis variable definition
- Drive parameter management

Motion Tree Manager automatically creates links between the CANopen bus configuration and the MFB function block data using a limited amount of configuration data.

General axis parameters

In this tab, the designer is prompted to define:

- The name of the axis that will identify it in the browser for the entire application
- The address of the drive on the CANopen bus

Axis parameters

The drop-down lists in this tab are used to determine the exact type of drive: family, version.

Variable names

This last tab is used to identify data structures:

- **Axis_Reference**: Used by the function block instances for the axis in question
- **CAN_Handler**: Used to manage communication with the drive via the CANopen network

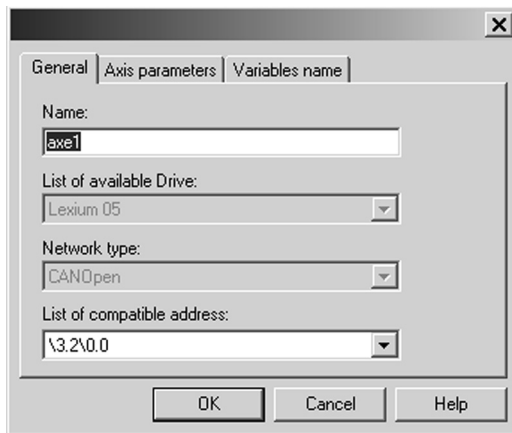

General parameters: Axis name and address

Recipe definition

The recipes attached to the axis are the data structures containing the adjustment parameters of a given drive. This data is used when:

- Changing the drive with restoration of the context during "Faulty Device Replacement" (FDR) maintenance
- Changing the manufacturing program of the machine and calling up an appropriate set of parameters: servo control gains, limitations, etc. adapted to the weight and size of the moving parts
- Saving parameters in the initial values of the PLC application

Programming, diagnostics, and maintenance

Communication between the PLC and drive is automatically set up by the system as soon as a TE_CAN_Handler instance is declared in the EcoStruxure Control Expert (1) task with which the axis is associated. Movements are then programmed by sequencing function blocks from the library in the user's chosen EcoStruxure Control Expert (1) editor (LD, ST, FBD).

The two function blocks, MC_ReadStatus, and in some cases MC_ReadAxisError, are useful for determining the overall status of the axis, as well as the code of the active detected errors.

The function blocks TE_UploadDriveParam and TE_DownloadDriveParam allow the application to save the drive parameters (recipe) and to then quickly reload them into another drive when it is necessary to change the original one.

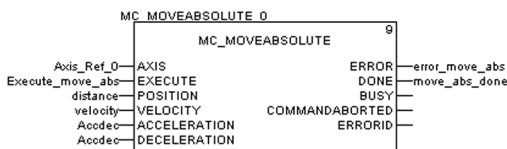

MFB: Programming a movement in absolute mode

(1) EcoStruxure Control Expert software continues the Unity Pro range of software and corresponds to versions ≥ 14 of Unity Pro.

Presentation

The **BMXETM0200H** frequency input module offers turbine shaft and engine speed monitoring functionality for general purpose turbomachinery control (TMC) applications. It can be integrated into Modicon M340 and M580 standard and high-availability systems.

TMC applications include prime movers, driven equipment, auxiliaries, mechanical retrofits, and protection. With the Modicon Package solution, the frequency input and measurement function is available for the following general purpose TMC application types:

- Large hydro turbines
- Small steam turbine generators
- Small hydro turbines
- Small mechanical drive gas turbines
- Diesel generators
- Reciprocating compressors
- Packaged air compressors
- Single-stage mechanical drive turbines: pumps

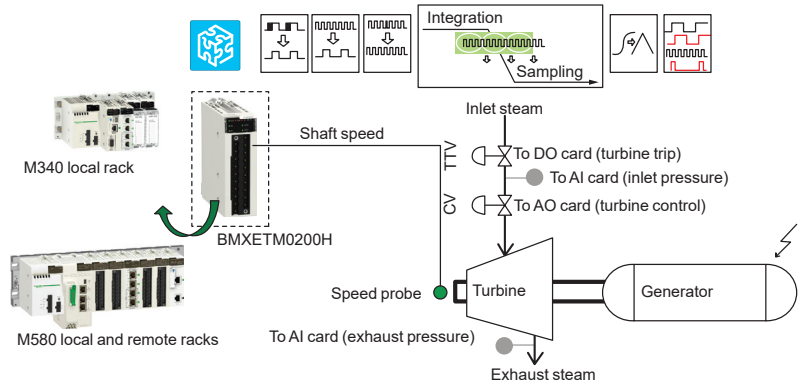

TMC governor control system architecture

Functionality

The purpose of the **BMXETM0200H** module is to monitor the turbine shaft or engine speed. It is designed to receive electrical pulses generated by the gear tooth sensing probe, cam, and crank etc. and convert these pulses into a numerical value. The measured value of the turbine shaft rotating velocity is highly accurate with a fast refresh rate.

With the **BMXETM0200H** module providing frequency input and measurement, Modicon PACs build up a closed loop control system as part of the turbomachinery governor. This control mechanism will automatically track and direct the speed of driven equipment (such as a generator or compressor) and a prime mover (such as a turbine or engine) under varying load conditions with the aim of:

- maintaining the selected speed
- limiting slow and fast speeds
- helping to protect mechanical parts and customer investment by anticipating overspeeds by means of its acceleration and jerk detection capability



BMXETM0200H

Modicon X80 modules platform

X80 Expert modules

Frequency input module

Module specifications

Availability and compatibility

Available for Modicon M340 and M580 standalone and HSBY platforms, on local rack or RIO rack with hot swapping supported.

Ambient operating temperature

Hardened with extended temperature range from $-25...70\text{ }^{\circ}\text{C}/-13...158\text{ }^{\circ}\text{F}$ and conformal coating.

Measurement performance

Two frequency input channels for 1 V and 1 Hz signal up to a maximum of 500 KHz with 100 KHz, 10 KHz, and 1 KHz input filters.

Supported signal source device type

Speed sensor inputs support passive pickup, active speed sensor (output OC, TTL, ST), potential transformer, and incremental encoder.

Digital reflex outputs

1 positive 24 VDC reflex digital output per channel controlled from an embedded comparator.

Error detection

Detects broken wire and probe health status.

Dedicated TMC functions

A set of dedicated TMC functions for turbine shaft monitoring, including:

- Frequency pattern recognition up to 512 pulses per pattern
- Acceleration and jerk detection
- Phase angle and ratio detection between channels
- Scaling factor for RPM measurement up to 1,024 teeth per revolution
- Alarm bits that can be time-stamped by the Modicon M580 controller

Software configuration

Configurable using EcoStruxure Control Expert (1) or Unity Pro V11 (S, L, and XL) with TMC Hotfix integrated.

Reference

X80 Frequency input module

Description	Composition	Reference	Weight kg/lb
Turbomachinery frequency input module (2 channels) for severe environments	1 ms cycle time	BMXETM0200H	0.124/
	2 digital reflex outputs 2 discrete inputs (for frequency measurement functions)		0.273

(1) EcoStruxure Control Expert software continues the Unity Pro range of software and corresponds to versions ≥ 14 of Unity Pro.

Technology
Partner

Schneider
Electric

PMESWT0100 Scaime partner
weighing module

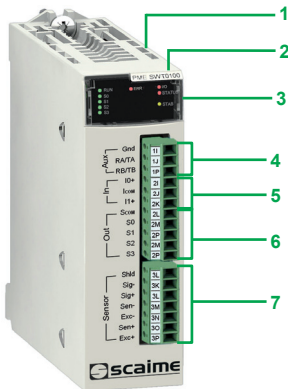

PMESWT0100

6

Presentation

The **PMESWT0100** Scaime partner weighing module is integrated in a Modicon X80 modules platform with an Ethernet + X-bus **BMEXBP●●00(H)** rack and a Modicon M580 **BMEP58●0●0** PLC or in a Modicon X80 RIO drop with an Ethernet + X-bus **BMEXBP●●00(H)** rack and a **BMECRA31210** adapter.

With this module, it is possible to go beyond the scope of a simple weighing application: it is suitable for static weighing applications such as silo level measurement and scale weighing; it is also well suited to low-speed dynamic weighing applications such as filling, dosing, and material transfer.

The Modicon X80 modules platform can manage the whole weighing environment as well as the whole machine or industrial process associated with the weighing system.

Indeed, weighing data is accessible by the PLC via implicit exchanges or explicit commands. Once the weighing signal is received, it is processed and transferred by the weighing module to the Modicon M580 PLC via the Ethernet backbone. This Ethernet weighing transmitter offline configuration, online calibration, monitoring, and weighing diagnostics are achieved using EcoStruxure Control Expert (1) software via FDT/DTM.

The Scaime partner weighing module has been developed to comply with the general standards and certifications of the Modicon X80 modules platform. For more information, see [page 10/2](#) or consult our website www.se.com.

Description

The **PMESWT0100** weighing module features the following:

- 1 A rigid body providing support and protection for the electronic card
- 2 A module reference marking (a label is also visible on the right-hand side of the module)
- 3 A module and channel status display block
- 4 Screw clamp terminals for connecting an external HMI output
- 5 Screw clamp terminals for connecting discrete reflex inputs
- 6 Screw clamp terminals for connecting discrete reflex outputs
- 7 Screw clamp terminals for connecting input load cells

Main characteristics

Measurement input

1 weighing channel per module, comprising up to 8 load cells connected via junction box

Input load cell supply voltage

5 V $\overline{\text{DC}}$

Internal resolution

24-bit converter

User resolution

Up to 1,000,000, factory-calibrated 500,000 at 2 mV/V

Internal measurement rate

6 to 400 measurements per second

External measurement rate

100 measurements per second

Discrete reflex outputs

Number of applications

4 positive logic outputs, 2 for dosing and 2 for threshold monitoring

Maximum voltage

55 V $\overline{\text{DC}}$

Nominal current

400 mA

Response time

2 ms discrimination

Discrete inputs

Number of applications

2 positive logic inputs, weighing functions

Low voltage range

0...3 V $\overline{\text{DC}}$

High voltage range

9...28 V $\overline{\text{DC}}$

High current

20 mA at 24 V $\overline{\text{DC}}$

(1) EcoStruxure Control Expert software continues the Unity Pro range of software and corresponds to versions ≥ 14 of Unity Pro.



PMESWT0100

References

X80 Weighing module

Description	Composition	Reference	Weight kg/lb
Scaime partner weighing module (1) (1 weighing channel per module)	<ul style="list-style-type: none"> - Load cell input 100 measurements/s (for 1 to 8 load cells) - 4 discrete reflex outputs (for threshold monitoring and dosing) - 2 discrete inputs (for weighing functions) - 1 output for an external HMI 	PMESWT0100 (2)	0.233/ 0.514

Technology Partner



(1) Partner Product, sold by SE and Scaime. Supported by Scaime, see our website www.se.com/en/partners/technology-partners/

(2) To order this product, please contact our Customer Care Center.

X80 Remote I/O drop adapter

- Presentation..... [page 7/2](#)
- Description, references..... [page 7/3](#)

X80 Peripheral remote I/O drop adapters

- Presentation..... [page 7/4](#)
- References [page 7/5](#)

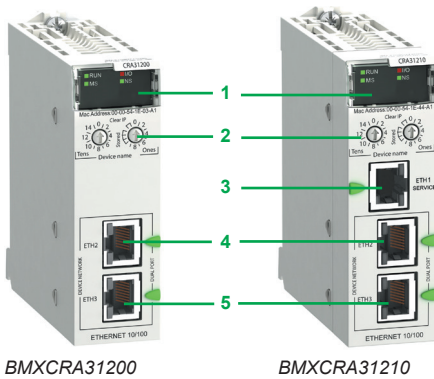

BMXCRA31200

BMXCRA31210



DIA6ED2151012EN

Modicon X80 Remote I/O drop adapters (1)(2)

Presentation

A Quantum EIO architecture with Modicon X80 EIO drops requires the use of a dedicated X80 Remote I/O drop adapter in each Modicon X80 drop:

- “Standard” drop adapter **BMXCRA31200** (capacity, see below)
- “Performance” drop adapter **BMXCRA31210** (capacity, see below)

These drop adapters are connected by Ethernet cordsets equipped with RJ45 connectors. The dual Ethernet network connection port on each drop adapter allows daisy chain loop connections using the RSTP protocol (Rapid Spanning Tree Protocol).

Each module uses one slot in the Modicon X80 rack.

The **BMXCRA31210** adapter is also available in a conformal coating version for harsh environments.

Capacity of Quantum EIO architectures with Modicon X80 EIO

- 1 Quantum CPU drop that can have one primary rack and one secondary rack (3), equipped with a **140CPU6●●●●** advanced CPU
- With **140CPU651●●** standard CPUs and the **140CPU67160** HSBY CPU:
 - Up to 16 Modicon X80 EIO drops, limited to a maximum of 31 EIO drops (Quantum + Modicon X80)
- With the **140CPU65260** standard CPU and **140CPU6726●** HSBY CPUs:
 - Up to 31 Modicon X80 EIO drops, limited to a maximum of 31 EIO drops (Ethernet Quantum and Modicon X80)
- Each Modicon X80 EIO drop can comprise one primary rack and one secondary rack (3)
- Distance:
 - 100 m/328 ft between stations (copper medium)
 - 2 km/1.25 mi between Modicon X80 drops, with **BMXNRP0200** multimode fiber optic repeaters
 - 16 km/9.94 mi between Modicon X80 drops, with **BMXNRP0201** single-mode fiber optic repeaters

Description

- 1 Display block indicating the module status
- 2 Rotary switches for addressing EIO drops (00...159)
- 3 On **BMXCRA31210** module: dedicated RJ45 SERVICE port for remote service tools such as a PC, an HMI terminal, or Ethernet DIO devices (identical to the SERVICE port on Quantum CRP/CRA modules, see [page 2/6](#))
- 4 RJ45 DEVICE NETWORK port for connection to the Ethernet network
- 5 RJ45 DEVICE NETWORK port for connection to the Ethernet network

(1) For additional characteristics, see our website www.se.com.

(2) Requires Unity Pro Extra Large software ≥ V7.0 or EcoStruxure Control Expert.

(3) Requires two **BMXXBE1000** rack expansion modules (one in the primary rack and one in the secondary rack) and a **BMXXBC●●●K** extension cable (0.8, 2, or 28 m/2.62, 6.56, or 92 ft) for connecting these two modules (see [page 2/8](#)).



BMECRA31210



DIA6ED2151012EN

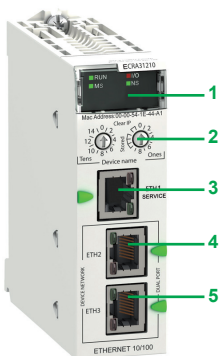

BMECRA31210

Modicon X80 Performance Remote I/O drop adapter

Presentation

An M580 Ethernet RIO (EIO) architecture with Modicon X80 I/O drops requires the use of a dedicated adapter in each Modicon X80 drop.

The **BMECRA31210** adapter supports Ethernet and X-bus communications across the remote backplane.

This EIO adapter module supports several expert modules such as counter and weighing modules and CCOTF («change configuration on the fly»).

For Modicon X80 RIO drops on an Ethernet backplane, time-stamping can be managed with a resolution of 10 ms when using a **BMECRA31210** Performance adapter.

Only one **BMECRA31210** module can be installed per Modicon X80 RIO drop. This module can also support a BMXXBP●●00 expansion rack.

The **BMECRA31210** module is designed to be installed on an Ethernet backplane in the main remote rack. The adapter supports the Modicon X80 I/O and partner modules with both Ethernet and X-bus connections (1).

The keying pin on the rear side of the module means the **BMECRA31210** module cannot be installed on unsupported backplanes.

These adapters are connected by Ethernet cordsets equipped with RJ45 connectors. The dual Ethernet connection port on each adapter allows daisy chain loop connections using the RSTP protocol (Rapid Spanning Tree Protocol).

The **BMECRA31210** adapter is also available in a conformal coating version for harsh environments.

Capacity of Modicon X80 Remote I/O drop adapters

Type of module	BMXCRA31200 "Standard"	BMXCRA31210 "High performance"	BMECRA31210 "High performance"
Maximum number of racks per drop	Up to 2	Up to 2	Up to 2
SERVICE port	–	1	1
Discrete I/O modules	Up to 128	Up to 1024	Up to 1024
Analog I/O module	Up to 16	Up to 256	Up to 256
Expert modules supported:			
■ Serial link	–	BMXNOM0200	BMXNOM0200
■ Time- and date-stamping at 1 ms	–	BMXERT1604T/H	BMXERT1604T/H
■ Counter	–	BMXEHC0200/ BMXEHC0800	BMXEHC0200/ BMXEHC0800
■ Weighing	–	–	PMESWT0100
■ Frequency input	–	BMXETM0200H	BMXETM0200H
■ HART integrated analog I/O modules	–	–	BMEAHI0812/ BMEAHO0412
CCOTF function	–	Yes	Yes
Time- and date-stamping	–	10 ms	10 ms

Description

- 1 LED display block indicating the module status
- 2 Rotary switches for setting the address of an EIO drop (00...159)
- 3 Dedicated RJ45 service port (ETH 1) for remote service tools such as a PC, HMI terminal module, or Ethernet DIO devices
- 4 RJ45 device network port (ETH 2) for connection to the Ethernet network
- 5 RJ45 device network port (ETH 3) for connection to the Ethernet network

References

X80 Remote I/O drop adapters

Description	SERVICE port	Reference	Weight kg/lb
Standard module	1	BMXCRA31200	–
High performance module	1	BMXCRA31210 BMECRA31200	–

(1) This module is also compatible with X-bus backplanes. In this case it has the same functionality as a **BMXCRA31210** Performance Ethernet drop adapter. For more details, see our website www.se.com.

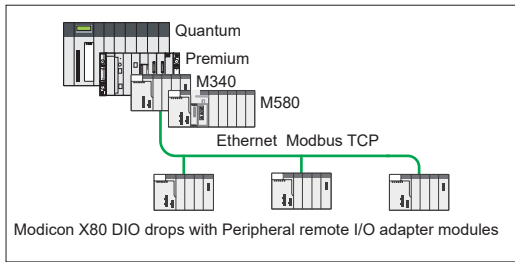

Modicon X80 DIO drops in a Quantum/Premium/M340/M580 I/O architecture using Ethernet Modbus TCP

Presentation

The **BMXPRA0100** Peripheral remote I/O adapter is dedicated to Modicon X80 DIO drops in a Quantum/Premium/M340/M580 I/O architecture using Ethernet Modbus TCP.

The BMXPRA0100 module manages a remote X80 I/O rack on Ethernet Modbus TCP which includes:

- discrete I/O modules
- analog I/O modules

It communicates by I/O scanning with the master PAC (Quantum/ Premium/M340/ M580).

In case of a redundant Ethernet link, the use of a BMXNOE0100 Ethernet module is required.

Principal characteristics

Primary racks per drop

Up to 4

Discrete I/O modules

Up to 1,024

Analog I/O modules

Up to 256

Internal memory

Up to 448 Kbits

Memory card capacity

Up to 96 Kbits

Average consumption

95 mA

Dissipated power

2.3 W

Real time clock with battery backup

Yes

Description

- 1 Module reference
- 2 Display block indicating the module status
- 3 Memory card port with protective cover
- 4 RJ45 Ethernet port

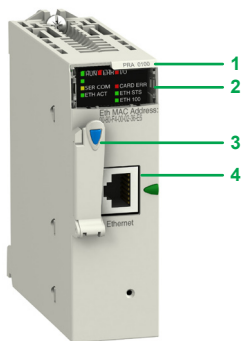

BMXPRA0100

Modicon X80 modules platform

X80 I/O expansion modules

Peripheral remote I/O adapter

PFI22533A



BMXPRA0100

Reference (1)		
Description	Reference	Weight kg/lb
X80 Peripheral remote I/O adapter Provides 1 module per Ethernet Modbus TCP DIO drop	BMXPRA0100	—

(1) Requires Unity Pro software ≥ V4.1 or EcoStruxure Control Expert.

Selection guide page 8/2

X80 AS-Interface module

- Presentation, description page 8/4
- Diagnostics, references page 8/5

X80 Modbus and Character mode serial link module

- Presentation, description page 8/6
- Characteristics, references page 8/7

X80 CANopen master module

- Presentation, description page 8/8
- Diagnostics, references page 8/9

X80 PROFIBUS DP module

- Presentation, description, architecture page 8/10
- Software configuration, diagnostics, references page 8/11

Modbus Plus Proxy

- Presentation, description page 8/12
- References page 8/13

X80 Fiber converter modules

- Presentation, description page 8/14
- References page 8/14

X80 Ethernet switch module

- Presentation, description page 8/15
- References page 8/15

* Communication modules specific to M580 ePAC or M340 PAC are not described in this chapter, please refer to M580 and M340 catalogs.

Modicon X80 modules platform

X80 Communication modules

Communication modules

Applications	AS-Interface communication	Serial link communication	CANopen communication
Type of device	AS-Interface module	Modbus and Character mode serial link module	CANopen master module



		AS-Interface	Modbus and Character mode	CANopen
Network protocols				
Structure	Physical interface	AS-Interface V3 standard	Non-isolated RS-232, 8-wire Isolated RS-485, 2-wire	ISO 11898
	Type of connector	3-way SUB-D	1xRJ45 and 2XRJ45	9-way SUB-D male
	Access method	Master/slave	–	Master/slave
	Data rate	167 Kbps	0.3...115.2 Kbps in RS 232 0.3...57.6 Kbps in RS 485	500 Kbps at 100 m/328 ft 1 Mbps at 20 m/65.62 ft
Medium		2-wire AS-Interface cable	Shielded twisted pair copper cable	Shielded twisted pair copper cable
Configuration	Maximum number of devices	62 slaves	2 per drop, 16 per Ethernet remote I/O (RIO) network max.	63 slaves
	Maximum length	100 m/328 ft, 500 m/1640 ft max. with 2 repeaters	15 m/49.21 ft with non-isolated RS 232, 1000 m/3280 ft with non-isolated RS 485	100 m/328 ft 2,500 m/8,202 ft with repeater
	Number of links of the same type per station	BMXP341000 processor: 2 AS-Interface modules	20/36 application-specific channels with BMXP341000/P342 (1 application-specific channel = 1 counter, motion control, or serial link module channel)	Limitation depends on number of available Ethernet slots in Modicon M580 Local and Remote Racks
		BMXP3420 or BMEP58 processor: 4 AS-Interface modules	36 application specific channels max. 6 BMXNOM0200 modules per BM-CRA31210 Ethernet drop adapter (1)	Each BMECXM0100 counts as a DIO devices. Number of DIO devices depends on CPU/NOC capacity and IO scanner memory
	BM-CRA31210 Ethernet drop adapter: 2 AS-Interface modules	All M580 processors: 36 application-specific channels	–	
Standard services		Transparent exchanges with the sensors/actuators	Read/write bits and words, diagnostics in Modbus mode	Transparent exchanges with CANopen slaves and Ethernet-based processors
Conformity class		M4 profile	–	EDS description files of the slaves
Communication services		–	–	Gateway DTM FDR Service SNMP agent Syslog client
Compatibility with processor		Modicon M340, Modicon M580	–	Modicon M580 only
References		BMXEIA0100	BMXNOM0200	BMECXM0100
Page		8/5	8/6	8/8

(1) Only BMXNOM0200

Modicon X80 modules platform

X80 Communication modules

Communication modules

Applications	PROFIBUS communication	Modbus Plus communication
Type of device	PROFIBUS DP master module	Modbus plus Proxy



		PROFIBUS DP	Ethernet Modbus TCP	Modbus Plus
Network protocols				
Structure	Physical interface	RS-485	10/100BASE-TX	RS-485
	Type of connector	9-way SUB-D female	2 x RJ45	2 x 9-way female SUB-D
	Access method	Master/slave, Token passing	CSMA/CD	HDLC -Token passing
	Data rate	9.6 kbit/s at 1200 m/3.937ft 12 Mbit/s at 100 m/328 ft	10/100 Mbps	1 Mbps
Medium		Shielded twisted pair copper cable	Double shielded twisted pair copper cable, category CAT 5E (direct or crossover)	Shielded twisted pair copper cable
Configuration	Maximum number of devices	10 masters, 125 slaves	128	32 per segment 64 for all segments
	Maximum length	1200m/3.937ft per segment	100 m/328 ft	450 m/1.476 ft per segment 1,800 m/5.905 ft with 3 repeaters
	Number of links of the same type per station	Up to 10 PMPX0100 modules in total with a Modicon M580 BMEP586040 processor	1 max.	–
Standard services		Cyclic data exchange (master class1) Acyclic data exchange (master class2)	Modbus/TCP messaging	Modbus Plus messaging
Conformity class		PI International certified		
Communication services		Gateway DTM FDR Service SNMP agent Syslog client	Modbus Plus server (scanned by the PLC) FDR service SNMP agent	Read/write variables Global Data Peer Cop service
Compatibility with processor		Modicon M580 only	Modicon M340, Modicon M580	
References		PMPX0100	TCSEGDB23F24FA	
Page		8/10	8/12	



Presentation

The **BMXEIA0100** master module for AS-Interface cabling system provides the AS-Interface system master function for the Modicon X80 modules platform.

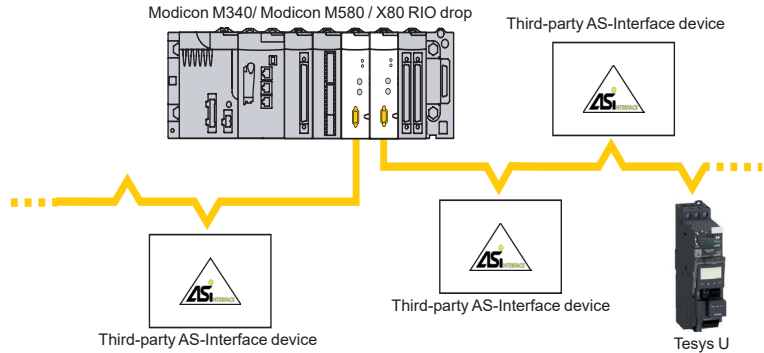

The AS-Interface cabling system consists of a master station (Modicon X80 modules platform) and slave stations. The master supporting the AS-Interface profile interrogates the devices connected on the AS-Interface line one-by-one and stores the information (actuator/sensor status, device operating status) in the PLC memory. Communication on the AS-Interface line is managed totally transparently in relation to the application PLC program.

The **BMXEIA0100** module supports the latest management profile for AS-Interface devices (*AS-Interface V3*), which is able to manage level V1, V2, and V3 AS-Interface slaves:

- Discrete slave devices (up to 62 devices of 4 inputs/4 outputs organized in 2 banks (A/B) of 31 addresses each)
- Analog devices (up to 31 devices (4 channels) in bank A)
- Safety interfaces (up to 31 devices in bank A)

An AS-Interface power supply is essential for powering the various devices on the line. Ideally it should be placed near stations that consume a great deal of energy. Please refer to the "Phaseo AS-i ABL Single phase power supplies 2.4 and 4.8 A for AS-Interface wiring system" catalog.

A Modicon M340 Performance configuration with a **BMXP3420●0/20●02** processor or a Modicon M580 configuration with a **BMEP58●●●●** processor can take 4 **BMXEIA0100** modules. A Standard configuration with **BMXP341000** processor can take 2 **BMXEIA0100** modules.

Description

The **BMXEIA0100** AS-Interface master module is standard format (1 slot). Its housing provides IP20 protection of the electronics and it is locked into each rack slot (**01 ...11**) by a captive screw.

The front panel of the **BMXEIA0100** AS-Interface master module features:

- 1 A rigid body providing support and protection for the electronic card
- 2 A module reference marking
- 3 A display block with 5 LEDs indicating the module operating modes:
 - RUN (green): Module running
 - ERR (red): Detected module fault
 - A/B (green): Displays the group of 31 slaves
 - I/O (red): Detected I/O fault on AS-Interface line
 - 32 LEDs for diagnostics of the AS-Interface line and each slave connected on the line depending on the A/B pushbutton selection (1)
- 4 2 LEDs marked ASI POWER and FAULT: AS-Interface external power supply present and detected AS-Interface line fault (see diagnostics on [page 8/5](#))
- 5 Two pushbuttons marked A/B and MODE (see diagnostics on [page 8/5](#))
- 6 A 3-way male SUB-D connector for the AS-Interface cable (female screw clamp connector supplied)

(1) Depending on whether A or B is selected, this displays either the first 31 slaves (standard addressing) or the last 31 slaves (extended addressing).

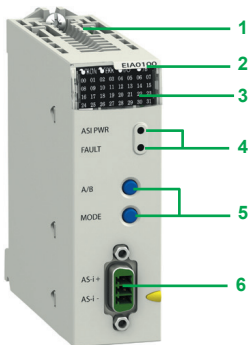

BMXEIA0100

Diagnostics

The two LEDs **4** on the module front panel are used in conjunction with the two pushbuttons **5** for module diagnostics:

LEDs		Pushbuttons	
4 ASI PWR: AS-Interface power supply present	4 FAULT: Detected AS-Interface line fault	5 A/B: Selects the group of slaves on the display block 3	5 MODE: Module Offline/Online

The display block on the front panel of the **BMXEIA0100** master module can be used to perform simplified local diagnostics by displaying the slave devices present on the AS-Interface line.

Detailed diagnostics of each slave device is also possible using:

- An adjustment terminal (1)
- A Web browser using the Rack Viewer function in the standard Web server on the Modicon X80 modules platform. For further information, please consult our website www.se.com.

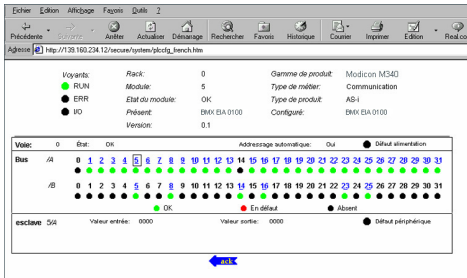

Rack function display in Web browser

References

X80 AS-Interface module

Description	Usage	Reference	Weight kg/lb
AS-Interface master module supplied with 3-way male SUB-D connector	M4 AS-Interface profile for level V1, V2, and V3 slaves	BMXEIA0100	0.340/ 0.750

(1) For instance, see our [Bihl+Wiedemann partner offer](#).



Presentation

The Modbus serial link is used for client/server architectures (it is necessary, however, to check that the Modbus services used by the application have been implemented on all relevant devices).

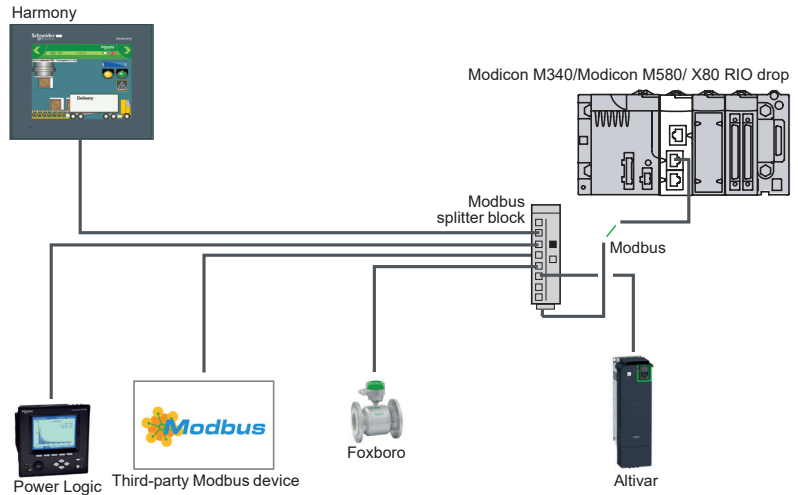

The bus consists of a client station and server stations. Only the client station can initiate the exchange (direct communication between server stations is not possible). Two exchange mechanisms are available:

- Question/response, where requests from the client are addressed to a given server. The client then waits for the response from the server that has been interrogated.
- Broadcasting, where the client broadcasts a message to all server stations on the bus. The latter execute the order without transmitting a reply.
- It is necessary to use **BM•CRA31210** modules as drop adapters. On one drop it is possible to plug a maximum of two **BMXNOM0200** modules.

The following services are not available in the server stations:

- Modbus server
- Modem services

Although most processors have a serial link that can support modems, the **BMXNOM0200** 2-channel serial link module is particularly recommended for this type of use.

Its performance and numerous parameter-setting options make it ideal for any type of configuration, especially when using radio modems.

Description

X80 serial link module

The front panel of the **BMXNOM0200** serial link module features:

- 1 A screw for locking the module in a slot in the rack
- 2 A display block with 4 LEDs:
 - RUN (green) and ERR (red): Module status
 - For each of the two channels: SER COM (green): Activity on the serial link (lit/ detected fault on a device present on the serial link (flashing)
- 3 Two RJ45 connectors (exclusive use) for connection of channel 0 (with black indicator):
 - 3a A connector for RS 232C connection, marked COM Port 0 RS232
 - 3b A connector for RS 485 connection, marked COM Port 0 RS485
- 4 An RJ45 connector for RS 485 connection of channel 1, marked COM Port 1 RS485, with black indicator

To be ordered separately:

RS 485 cordsets (refer to the "Modicon M580 automation platform" catalog available on our website www.se.com) or RS 232 cordsets for DCE terminal (see [page 8/7](#)).

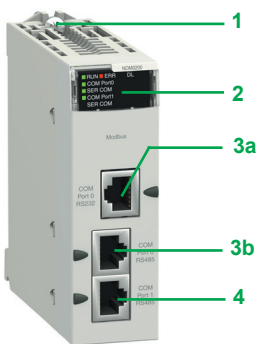

BMXNOM0200



EcoStruxure Control Expert monitor



BMXNOM0200



DIA6ED2151012EN

Complementary characteristics

The following characteristics complement those indicated in the selection guide on [page 8/9](#).

BMXNOM0200 module serial links

- Physical interface:
 - RS 232 port 0: RS 232 8-wire, non-isolated
 - RS 485 port 0 and port 1: RS 485 2-wire, isolated
- Frame:
 - Modbus: RTU/ASCII, full duplex in RS 232, half duplex in RS 485
 - Character mode: full duplex in RS 232, half duplex in RS 485
- Data rate:
 - RS 232 port 0: 0.3...115 Kbps (Modbus/Character mode)
 - RS 485 port 0 and port 1: 0.3...57.6 Kbps (Modbus/Character mode)
- Line polarization:
 - Modbus RS 485: automatic
 - RS 485 character mode: configurable with EcoStruxure Control Expert (1) software
- Maximum length of a tap link in RS 485 2-wire:
 - 15 m/49 ft in a non-isolated link
 - 40 m/131 ft in an isolated link
- Expert mode (from version V1.2 of the module and version V5 of Unity Pro (1): used to configure the time out links individually from the application and thus adapt to the specific characteristics of certain modems.

References (2)

X80 Serial link module

Description	Protocol	Physical layer	Reference	Weight kg/lb
2-channel serial link module (3)	Modbus client/server RTU/ASCII, Character mode, GSM/GPRS modem	1 non-isolated RS 232 channel (Port 0) 2 isolated RS 485 channels (Port 0 and Port 1)	BMXNOM0200	0.230/ 0.507

Cordsets for RS 232 serial link (4)

Description	Connexion	Number of wires	Length m/ft	Reference	Weight kg/lb
Cordset for Data Terminal Equipment (DTE) (printer)	RJ45 connector and 9-way female SUB-D connector		3/ 9.84	TCSMCN3M4F3C2	0.150/ 0.331
Cordset for Data Communication Equipment (DCE) (modem, etc.)	RJ45 connector and 9-way female SUB-D connector	4-wire (RX, TX, RTS, CTS) 8-wire (excluding RI signal)	3/ 9.84	TCSMCN3M4M3S2 TCSXCN3M4F3S4	0.150/ 0.331 0.165/ 0.364

(1) EcoStruxure Control Expert software continues the Unity Pro range of software and corresponds to versions ≥ 14 of Unity Pro.

(2) Requires Unity Pro software $\geq V1.4$.

(3) For the ruggedized version, **BMXNOM0200H**, see characteristics on [page 9/9](#).

(4) RS 485 serial link connection (refer to the "Modicon M580 automation platform" catalog available on our website www.se.com).

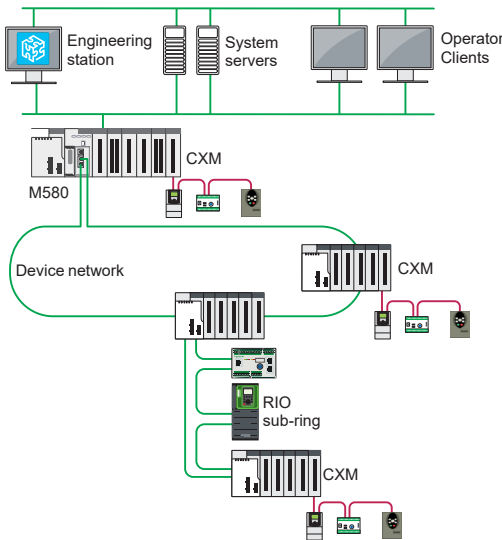

Typical topology to connect CANopen devices to M580/X80 platforms with BMECXM0100

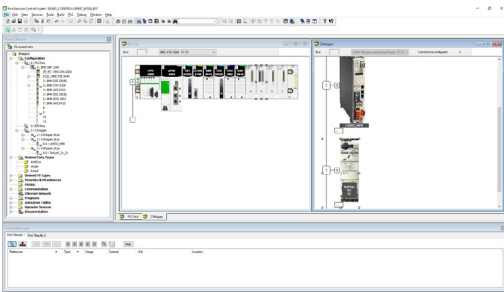

Configuring CANopen with EcoStruxure Control Expert

Presentation

CANopen is an open network supported by more than 600 companies worldwide, and promoted by CAN in Automation (CiA). With the general acceptance of CANopen, Schneider Electric has the accumulated and proven experience of applying CANopen in machine solution platforms.

CANopen helps to ensure reliable and deterministic access to real-time data in field devices. As a consequence, products using CANopen are increasingly used in control system architectures. The **BMECXM0100** CANopen master module provides powerful access to the CANopen slaves from the M580 local rack or a remote X80 drop.

Advantages

BMECXM0100 is designed to fulfill customer needs by offering the following advantages:

- Operational intelligence:
 - Complete software integration into Unity with a predefined catalog of preferred devices and numerous automated operations such as device variable creation, IP/DHCP settings, and IO scanner configuration
 - Simple integration of third-party devices
- Maintenance excellence:
 - Robust and well-designed with a long life cycle following X80 standards
 - Built to withstand extreme temperatures (-25 °C to +70 °C/-13 °F to +158 °F), ATEX certified
 - Easy diagnostics by maintenance engineers via a simple Web browser (no need for Unity) and the FDR (Fast Device Replacement) service
- Investment protection: Totally flexible topologies with the possibility of using several **BMECXM0100** modules in a single M580, or in a remote I/O drop closest to the process
- Time-to-market: Simple, compact size, all in one, which reduces installation time
- Enhanced protection and security: Integrated cybersecurity design helps to protect plant operations

Description

The **BMECXM0100** CANopen X80 master module is standard format (1 slot) and supports one CANopen port (SUB-D9 male connector).

The **BMECXM0100** supports up to 63 slaves with a maximum process image size of 4 Kbytes IN/4 Kbytes OUT.

Standardized baudrates between 20 Kbd and 1 Mbd (20 Kbd, 50 Kbd, 125 Kbd, 250 Kbd, 500 Kbd, 1 Mbd) are supported.

Depending on the performance level required by the process, the **BMECXM0100** module can be scanned by the RIO or the DIO scanner of the M580 CPU. RIO scanning helps to ensure optimum performance, in sync with the PLC task (MAST, FAST or AUX).

Several BMECXM modules can be connected to the same or different I/O scanners in the same M580 PAC.

BMECXM0100 modules are not compatible with redundant M580 architectures, and cannot be scanned by an Ethernet module including **BMENOC03•1** and **BMXNOC0402**.

Third-party CANopen slaves can only be configured in **BMECXM0100** modules from their EDS description files and via the hardware catalog manager. They cannot be configured from their DTM. Communication between the device and its DTM over Ethernet IO is also not supported.

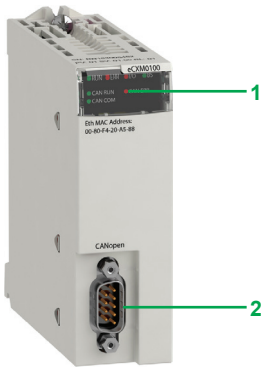

BMECXM0100

Diagnostics

The 5 LEDs **1** on the module front panel are used for quick CANopen communication diagnostics:

LED	Color	Description
I/O	Red	Indicates the exchange status with CANopen devices
BS (Bus Status)	Red/Green	Indicates the EtherNet/IP connection status
	Yellow	Firmware upgrade in progress
CAN RUN	Green	Indicates the status of the CANopen fieldbus
CAN ERR	Red	Indicates the status of the CANopen physical layer and indicates detected errors due to missing CAN messages (SYNC, node-guarding, or heartbeat)
CAN COM	Yellow	Dedicated to SDO transmission

References

X80 CANopen master module

Description	Reference	Weight kg/lb
Communication module used in M580/X80 Ethernet platform; supplied with male 9-way SUB-D connector 2	BMECXM0100 (1)	–

(1) For the "Conformal coating" version BMECXM0100H, see [page 9/9](#).



PMEPXM0100 PROSOFT partner PROFIBUS module

Presentation

Overview

The X80 PROFIBUS DP module allows the user to integrate PROFIBUS DP slave devices into Schneider Electric M580 control system to exchange process, alarming, and diagnostic data with PROFIBUS DP devices as well as to provide configuration and asset management of slave devices using Device Type Managers (DTMs).

This is an advanced in-rack solution for your PROFIBUS system compliant with Hot Standby (HSBY) and Standalone common Safety architectures.

New versions of M580 CPU and BMECRA31210 X80 Remote I/O drop adapter firmware and software are necessary to operate the module:

- CPU version ≥ V2.80
- BMECRA31210 version ≥ V2.40 if the module is used in a remote drop
- EcoStruxure Control Expert ≥ V14
- ProSoft Configurator for Modicon tool (PCM)

Advantages

The X80 PROFIBUS DP module is designed to meet customer needs by offering the following advantages:

- High performance, with up to 125 slave devices behind one module (2 Kb IN/2 Kb OUT), and up to 10 PROFIBUS masters in one M580 configuration
- Real-time PROFIBUS network analyzer with packet capture tool: accelerates the troubleshooting phase, fine tunes network options, and anticipates any maintenance needs
- Simple and ergonomic ProSoft Configurator for Modicon (PCM) with easy import into EcoStruxure Control Expert to efficiently build the PROFIBUS architecture
- Easy modernization from Quantum PTQ, user-friendly interface
- Achilles Level 2, HTTP, SNMP, Access control & Sys Log

Description

X80 PROFIBUS DP module is a PROFIBUS DP V1 master class 2 module that can be plugged in the M580 local rack or in any remote drop supporting the M580 Ethernet backplane depending on the architecture. It has an Autoscan feature to automatically poll and configure all the active slaves connected to the bus.

The PROFIBUS Communication DTM library is provided to enable the module interface by PROFIBUS Asset Management Tools.

“On the fly” operations, such as changing parameters or adding a new device online, are allowed.

The module is refreshed based on the RPI values, asynchronous to the periodic tasks. This refreshment is achieved via the Mast task with limited impact on the task duration, which is proportional to the device number.

The X80 PROFIBUS DP module can be scanned by the M580 CPU as well as by any Ethernet module (BMENOC●●●●). Nevertheless, the CPU capacity (mainly memory) is designed to be capable of managing all X80 PROFIBUS DP modules installed in the configuration. This simplifies the architecture and the process of modifying slave parameters via the “on the fly” feature, as well as that of adding new devices.

An advanced operating mode provides the option to stop the module while the PLC is in RUN in order to manage any modification without stopping the process.

Architecture

The X80 PROFIBUS DP module can be integrated into two types of architecture:

- Standalone:
 - Local racks and remote racks
 - Up to 6 modules in one configuration for high-end M580 CPU
 - Common Safety
- Redundant (HSBY):
 - Local rack only
 - Up to 6 modules in each rack for high-end M580 CPU

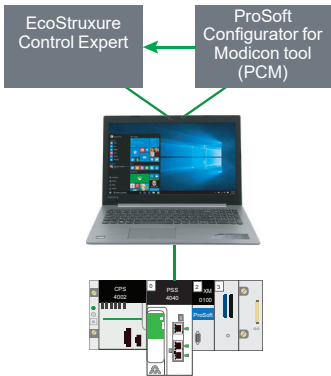

Interaction between EcoStruxure Control Expert, Prosoft Configurator for Modicon (PCM tool), and X80 PROFIBUS DP module

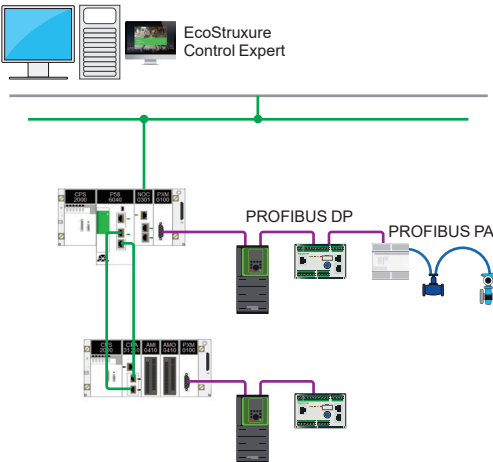

Standalone topology to connect X80 PROFIBUS DP module to M580/X80 platforms with PMEPM0100

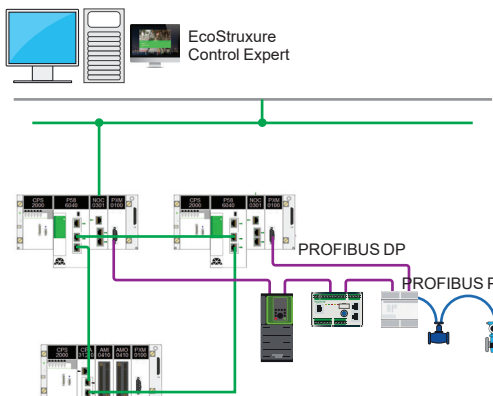

Redundant (HSBY) topology to connect the PROFIBUS DP master X80 module to M580/X80 platforms with PMEPM0100



ProSoft Configurator for Modicon tool (PCM)

ProSoft Configurator for Modicon tool (PCM)

The following are required to configure the **PMEPXM0100** X80 PROFIBUS DP module:

- EcoStruxure Control Expert V14 and higher
- ControlExpert_V140_HF_PMEPXM0100
- ProSoft Configurator for Modicon tool (PCM)

There is a strong interaction between EcoStruxure Control Expert and the Prosoft Configurator for Modicon (PCM). The ProSoft Configurator for Modicon tool (PCM) also provides the finest level of information and diagnostics on the module, on the bus, and on all the slaves. This tool is available at no additional cost on the Schneider Electric website in the product page section.

The PROFIBUS DP module is integrated from EcoStruxure Control Expert with high-level services:

- It is included natively in the EcoStruxure Control Expert (1) hardware catalog
- Exhaustive Device DDT for advanced control and diagnostics

Index	Time	Dir	Status	Src	Dest	Function	Details	Src SAP	Dest SAP	FDU	Data
0	0.327093	Rx	Ok	8	1	Response	Data	-	-	00:00:00	68:07:07:68:01:0...
1	0.331732	Tx	Ok	1	2	Request	SRD - Priority	-	-	02:03	68:05:05:68:02:0...
2	0.336113	Rx	Ok	2	1	Response	Data	-	-	03:00:00:00	68:05:05:68:01:0...
3	0.337257	Tx	Ok	1	1	Token	-	-	-	-	0C:01:01
4	0.338403	Tx	Ok	1	1	Token	-	-	-	-	0C:01:01
5	0.339544	Tx	Ok	1	1	Token	-	-	-	-	0C:01:01
6	0.427684	Tx	Ok	1	1	Token	-	-	-	-	0C:01:01
7	0.419322	Tx	Ok	1	8	Request	SRD - Priority	-	-	00	68:04:04:68:08:0...
8	0.423243	Rx	Ok	8	1	Response	Data	-	-	00:00:00	68:07:07:68:01:0...
9	0.427481	Tx	Ok	1	2	Request	SRD - Priority	-	-	02:03	68:05:05:68:02:0...
10	0.433963	Rx	Ok	2	1	Response	Data	-	-	03:00:00:00	68:05:05:68:01:0...
11	0.436925	Tx	Ok	1	6	Request	Request FDU Stat.	-	-	-	70:06:01:49:50:90
12	0.519374	Tx	Ok	1	1	Token	-	-	-	-	0C:01:01
13	0.511013	Tx	Ok	1	8	Request	SRD - Priority	-	-	00	68:04:04:68:08:0...
14	0.564553	Rx	Ok	8	1	Response	Data	-	-	00:00:00	68:07:07:68:01:0...
15	0.568231	Tx	Ok	1	2	Request	SRD - Priority	-	-	02:03	68:05:05:68:02:0...
16	0.626513	Rx	Ok	2	1	Response	Data	-	-	03:00:02:02	68:05:05:68:01:0...
17	0.610258	Tx	Ok	1	1	Token	-	-	-	-	0C:01:01
18	0.627623	Tx	Ok	1	1	Token	-	-	-	-	0C:01:01
19	0.623544	Tx	Ok	1	1	Token	-	-	-	-	0C:01:01
20	0.641184	Tx	Ok	1	1	Token	-	-	-	-	0C:01:01
21	0.698823	Tx	Ok	1	8	Request	SRD - Priority	-	-	00	68:04:04:68:08:0...
22	0.690343	Rx	Ok	8	1	Response	Data	-	-	00:00:00	68:07:07:68:01:0...
23	0.684880	Tx	Ok	1	2	Request	SRD - Priority	-	-	02:03	68:05:05:68:02:0...
24	0.731363	Rx	Ok	2	1	Response	Data	-	-	03:00:02:02	68:05:05:68:01:0...

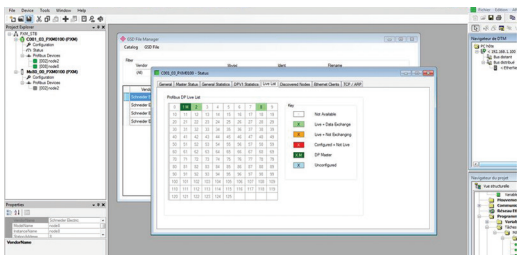

PMEPXM0100 status monitoring - Live List



PMEPXM0100

Diagnostics and monitoring

The 7 LEDs on the module front panel are used for quick PROFIBUS DP fieldbus communication diagnostics.

The X80 PROFIBUS DP module provides a range of statistics that can assist with module operation, maintenance, and fault finding. The statistics can be accessed by the Prosoft Configurator for Modicon or via the Web server embedded in the module.

References

X80 PROFIBUS DP module

Description	Reference	Weight kg/ lb
Used for M580 platform fieldbus communication	PMEPXM0100	0.270/ 0.595



(1) EcoStruxure Control Expert software continues the Unity Pro range of software and corresponds to versions ≥ 14 of Unity Pro.

Modicon X80 modules platform

X80 Communication modules

Modbus Plus Proxy

Presentation

The **TCSEGDB23F24FA** Modbus Plus Proxy module is a network gateway that allows Modicon M340 and M580 PLCs to communicate with existing Modbus Plus devices.

It is not necessary to modify the applications for these devices to communicate with the Modicon M340 and M580 PLCs, since the module automatically addresses the platforms and the various communication functions between the M340/M580 and other PLC platforms (especially 984LL).

The Modbus Plus Proxy offers Modbus Plus PLC users the chance to integrate M340 and M580 PLCs easily into their Modbus Plus network and thus to access advanced communications via Ethernet, or to migrate gradually from other PLC models to Modicon M340/M580 and EcoStruxure Control Expert (1).

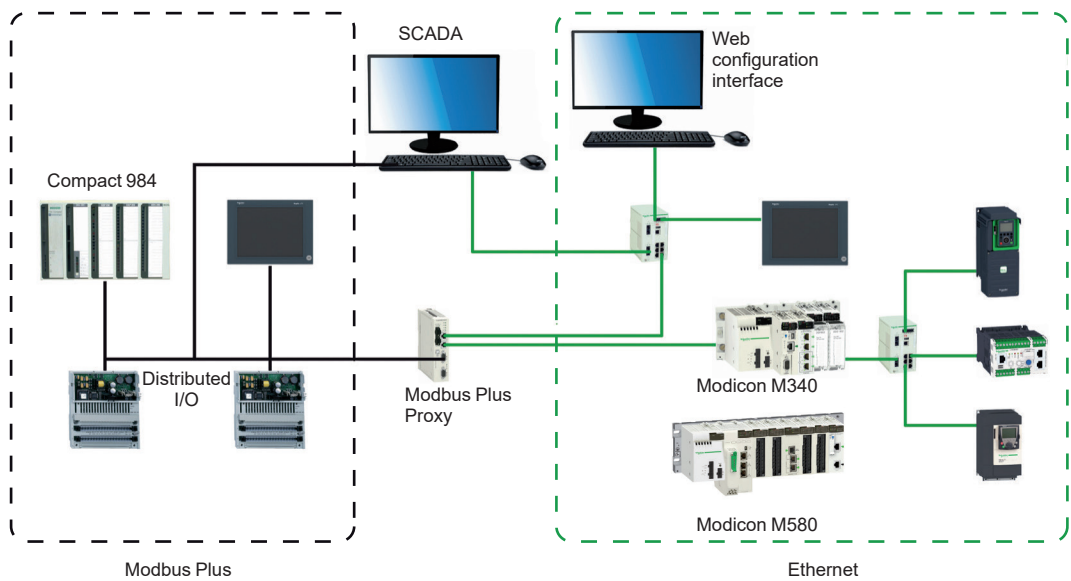

Key benefits

Reduced startup time

- Online configuration of the proxy via a simple Web browser
- Web page setup similar to the screens of the Modbus Plus Peer Cop utility, accessible under Concept/EcoStruxure Control Expert (1) for the Global Data transaction
- Simpler data exchange with Global Data transactions performed on all network nodes
- Point-to-point communication without programming with Peer Cop

Increased network reliability and maintainability

- Standard diagnostics provide data on all network nodes for easy troubleshooting
- Dual Modbus Plus ports provide Modbus Plus network redundancy

Reduced total cost of ownership

- Helps protect your investment in Modbus Plus while migrating to Ethernet
- Dual Ethernet ports allow connection of both the M340 or M580 PLC and the configuration PC to the proxy, without any additional switches

(1) Unity Pro software in earlier versions.

Modicon X80 modules platform

X80 Communication modules

Modbus Plus Proxy

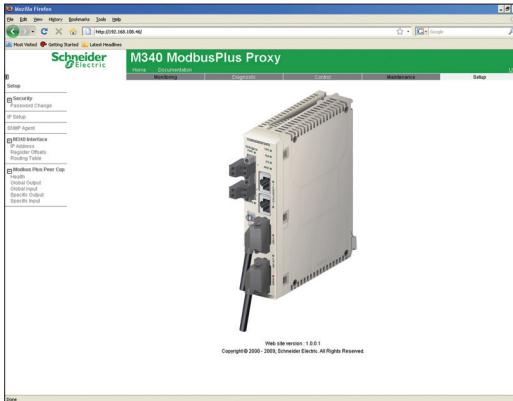

Embedded Web server

Web server functions

The Modbus Plus Proxy includes an embedded Web server that can be used to perform diagnostics and configure the module connection. Data is presented in the form of standard web pages in HTML format. To access a web page, you need Internet Explorer (version 6.0 or later) and Java (version 1.5 or later).

Embedded Web server functions

- 1 - Setup: The Setup pages allow you to define the parameters for several different module services, including security, IP, SNMP, Global Data, Peer Cop, and Ethernet ports.
- 2 - Diagnostics: These network diagnostic pages contain Ethernet, TCP, and SNMP statistics, as well as a log of the diagnostics performed.

Complementary characteristics

- External power supply voltage: 19.2...31.2 V $\overline{\text{---}}$
- Consumption: 300 mA max.
- Dissipated power: 6.2 W

References

System and network requirements

EcoStruxure Control Expert or Unity Pro XL programming software (version 3.x or later) (1)
 Internet Explorer (version 6.0 or later)
 Java (version 1.5 or later)
 Microsoft Windows XP or Vista

Modicon M340 processors:

- BMXP342020 (Modbus and Ethernet version)
- BMXP3420302 (CANopen and Ethernet version)
- BMXP3420302CL (CANopen and Ethernet version) (2)

Modicon M580 processors:

- BMEP581020
- BMEP582020/BMEP582040(S)
- BMEP583020/BMEP583040
- BMEP584020/BMEP584040(S)
- BMEP585040
- BMEP586040

Ethernet Modicon M340 communication modules:

- BMXNOE0100
- BMXNOE0110
- BMXNOC0401

Modicon M580:

- BMENOC0301
- BMENOC0311
- BMENOC0321



TCSEGDB23F24FA

Modicon Modbus Plus Proxy

Description	Type	Reference	Weight kg
Modbus Plus Proxy module for Modicon M340 and M580 PLCs	Standard	TCSEGDB23F24FA	—
supplied with 2 front-mounted power supply connectors (2 positions)	Conformal coating	TCSEGDB23F24FK	—

(1) Unity V8.0 or later with M580
 (2) Memory card to be ordered separately for the **BMXP3420302CL** processor (see our website www.se.com).

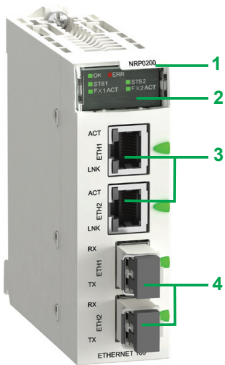

BMXNRP020

Modicon X80 Fiber converter module (1) (2)

Presentation

BMXNRP0200/0201 module offers an alternative to the use of Modicon managed dual ring switches (DRS), for fiber optic communications over long distances in Ethernet I/O systems (RIO or DIO).

When inserted in Modicon X80 EIO drops, **BMXNRP0200/0201** modules make it possible to:

- Extend the total distance of the EIO network when EIO drops are located in areas of the factory above 100 m/328 ft
- Enhance immunity to noise
- Resolve grounding incompatibilities between sites with different grounding methods

BMXNRP0200/0201 modules can be installed on the primary or secondary rings. These modules cannot, however, be used to connect secondary rings to the primary ring.

Following the distance of the remote location, you may select:

- The **BMXNRP0200** module for multimode optical fiber which allows remote location up to 2 km/1.25 mi., or
- The **BMXNRP0201** module for single-mode optical fiber which allows remote location up to 16 km/9.94 mi.

Depending on the configuration, the X80 Fiber converter module may be linked to the X80 Remote I/O drop adapter of the drop where it is installed, via 1 or 2 Ethernet Interlink cables.

Description

- 1 Module reference
- 2 Display block indicating the module status
- 3 RJ45 Ethernet ports (2 LEDs, LNK and ACT, indicate the status of each port)
- 4 Fiber optic ports with SFP transceiver for LC type connector

Instead of embedded switch, you may also use our external Modicon Switch described in the Modicon Switch catalog. They are all delivered with predefined parameters in order to optimize your architecture performances such as dual ring switch, management of main ring RIO, sub-ring or loop with DIO.



DIA6ED2140903EN

References (1)

X80 Fiber converter modules (2)

Description	Optical fiber	Reference	Weight kg/lb
Modules for fiber optic communications over long distances	Multimode	BMXNRP0200	—
	Single-mode	BMXNRP0201	—

(1) For additional characteristics, see our website www.se.com.

(2) Requires Unity Pro Extra Large software ≥ V7.0 or EcoStruxure Control Expert: see our website www.se.com.

Modicon X80 modules platform

X80 Communication modules

Ethernet switch module

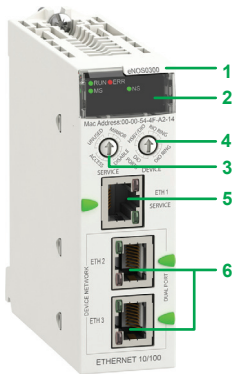

BMENOS0300



DIA6ED2140903EN

Ethernet switch module

Presentation

The **BMENOS0300** Ethernet switch module offers an economic alternative to the use of Modicon managed dual ring switches (DRS) for copper Ethernet communication over short distances in Ethernet I/O systems (RIO or DIO). Based on the rotary switches on the front panel, the application of the 2 device network ports can be configured intuitively as:

- RIO ring
- DIO ring
- DIO ports

Depending on the architecture, the **BMENOS0300** switch can be used to communicate with the distributed I/O by simply inserting it in the local main rack or remote drops.

Description

- 1 Module reference
- 2 Display block indicating the module status
- 3 Rotary switch for configuring the ETH 1 service port
- 4 Rotary switch for configuring the 2 device network ports (ETH 2 and ETH 3)
- 5 ETH 1: Service port (Ethernet)
- 6 ETH 2/ ETH 3: Device network port (Ethernet)

Instead of embedded switch, you may also use our external Modicon Switch described in the Modicon Switch catalog. They are all delivered with predefined parameters in order to optimize your architecture performances such as dual ring switch, management of main ring RIO, sub-ring or loop with DIO.

References (1)

X80 Ethernet switch module

Description	SERVICE port	Device network port (Ethernet)	Reference	Weight kg/lb
Switch for copper Ethernet communication over short distances	1	2	BMENOS0300	–

(1) For additional characteristics, see our website www.se.com.

9 - Dedicated parts for severe environments

Treatment for severe environments

- **Presentation** [page 9/2](#)
- Protective treatment for Modicon X80 modules platform..... [page 9/2](#)
- Treatment for severe environments [page 9/2](#)
 - Harsh chemical environments [page 9/2](#)
 - Extreme climate environments [page 9/2](#)
- Specific characteristics for Safety modules..... [page 9/2](#)
- X80 offer for severe environments composition [page 9/3](#)

Dedicated parts for severe environments

- **X80 Racks and rack expansion module for severe environments**
- References [page 9/4](#)
- **X80 Power supplies for severe environments**
- References [page 9/5](#)
- **X80 I/O modules for severe environments**
- X80 Discrete I/O modules [page 9/6](#)
- X80 Analog I/O modules [page 9/7](#)
- **X80 Expert modules for severe environments**
- X80 Counter modules [page 9/8](#)
- X80 Time-stamping module [page 9/8](#)
- X80 SSI encoder interface module [page 9/8](#)
- X80 Frequency input module [page 9/8](#)
- **X80 I/O expansion modules for severe environments**
- X80 Remote I/O drop adapter with conformal coating [page 9/9](#)
- **X80 Communication modules for severe environments**
- X80 Modbus and Character mode serial link module [page 9/9](#)
- X80 CANopen master module [page 9/9](#)
- X80 PROFIBUS DP module..... [page 9/9](#)
- X80 PROFIBUS DP network gateway [page 9/9](#)
- X80 Fiber converter modules [page 9/9](#)
- X80 Ethernet switch module [page 9/9](#)



Presentation

Protective treatment for Modicon X80 modules platform

The Modicon X80 modules platform complies with “TC” treatment requirements (treatment for all climates). It is designed as standard to operate in temperatures ranging from 0 to +60 °C/32 to 140 °F.

For installations in industrial environments corresponding to “TH” (treatment for hot and humid environments), devices must be housed in enclosures providing at least IP54 protection as specified by standard IEC/EN 60529, or an equivalent level of protection according to NEMA 250.

The Modicon X80 modules platform offers **IP20 protection** (1). It can therefore be installed within an enclosure in reserved access areas that do not exceed **pollution level 2** (control room with no conductive dust). **Pollution level 2** does not take account of harsher environments, such as those where the air is polluted with conductive dust, fumes, corrosive or radioactive particles, vapors or salts, molds, insects, etc. All the safety hardware in-rack modules colored red (processor, coprocessor, X80 I/O) are conformal coated for use in severe environments.

Treatment for severe environments

If the Modicon X80 modules platform has to be used in more severe environments or is required to start and operate in an extended temperature range, from **-25 °C to +70 °C/-13 °F to 158 °F** (only H or T version), the “**ruggedized**” offer features industrially hardened processor and power supply modules, X-bus and Ethernet I/O modules and racks that have a protective coating on their circuit boards.

Note: Capable of starting within an extended temperature range (from -25 °C to +70 °C/-13 °F to 158 °F, a single-rack configuration is also able to operate at extremely low temperatures (as low as -40 °C/-40 °F) if placed in an appropriate enclosure. Please contact our Customer Care Center.

The coated/harsh offer provides the Safety CPU/coprocessor and Safety I/O modules with “AVR 80” coating on their electronic cards. This treatment increases the isolation capability of the circuit boards and their resistance to:

- Condensation
- Dusty atmospheres (conducting foreign particles)
- Chemical corrosion, in particular during use in sulfurous atmospheres (oil refinery, purification plant, etc.) or atmospheres containing halogens (chlorine, etc.) or chemical vapors

This protection, combined with appropriate installation and maintenance, enables Modicon X80 platform products to be used in the following environments:

Harsh chemical environments (products with suffix ‘H’ and ‘C’)

The use of contact grease protection on connectors, removal blocks is mandatory to meet these requirements.

The lubricant protection seals electrical contacts from oxygen, moisture, aggressive gasses, and other hostile elements.

- **IEC/EN 60721-3-3 class 3C4:**
 - 7 days; 25 °C/77 °F relative humidity 75%
 - Concentrations (ppb): H₂S: 9,900/SO₂: 4,800/Cl₂: 200
- **ISA S71.04 classes G1 to Gx:**
 - 14 days; 25 °C/77 °F relative humidity 75%
 - Concentrations (ppb): H₂S: 60/SO₂: 350/Cl₂: 1,450/NO₂: 12
- **IEC/EN 60068-2-52 salt mist, Kb test severity level 2:**
 - 3 x 24-hour cycles
 - 5% NaCl
 - 40 °C/104 °F relative humidity 93%

Extreme climate environments (products with suffix ‘H’ and ‘T’)

- Temperatures ranging from -25 to +70 °C/-13 to 158 °F
- Relative humidity levels up to 93% from -25 °C/-13 °F to +60 °C/140 °F
- Formation of ice
- Altitudes from 0 to 5,000 m/0 to 16,404 ft

Note: Some products with the suffix ‘C’ also operate in an extended temperature range (from -25 °C to +60 °C/-13 °F to 140 °F). Please contact our Customer Care Center.

(1) Each slot in a **BM●XBP●●00** rack is equipped as standard with a protective cover that should only be removed when inserting a module. If any covers are subsequently misplaced, replacements can be ordered under reference **BMXXEM010** (sold in lots of 5).



Protective gel BMXGEL0025

Presentation (continued)

Specific characteristics for Safety modules

All Safety modules are coated and only exist with this surface treatment. There is no T, C, or H extension in the product references. Safety modules are compatible with:

- a temperature range from -25...+60 °C/-13...140 °F
- corrosive environments using common H components

A protective gel is needed to cover all electrical connections on X80 products used in corrosive environments.

This gel comes in a 25 g tube and can be ordered separately under the reference **BMXGEL0025**.

X80 offer composition for severe environments

To order ruggedized modules and racks, see the reference tables from [page 9/3](#) to [page 9/9](#) :

- References of available ruggedized products include the suffix "H"
- References of available conformal coated products include the suffix "C".

The majority of operating and electrical characteristics of ruggedized modules are identical to those of their equivalent standard versions. However, some characteristics are subject to either derating or limitation. Please consult our website www.se.com.

In this chapter, note that only X80 products are described.

- For M580 or M340 products, please refer to related catalog:



DIA6ED2151012EN



DIA6ED2110104EN

- For additional accessories, please refer to:
 - Standard accessories for racks, [page 2/5](#) and [page 2/9](#)
 - Standard accessories for power supplies, [page 2/3](#)
 - Standard accessories for I/O modules, [page 4/13](#)
 - Standard accessories for expert modules, [page 4/13](#)

Modicon X80 modules platform

Dedicated parts for severe environments
X80 Racks and rack expansion module for severe environments



BMXXBP0400H

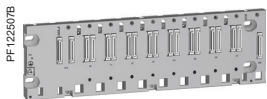

BMEXBP0800H



BMXXBE1000H

X80 Racks and rack expansion module for severe environments

Description	Type of module to be inserted	No. of slots (1)	Power consumption (2)	Reference	Weight kg/lb
Ruggedized X-bus racks	BMXCPS power supply, BMXP34 or BMEP58 processor, BMEH58 processor, I/O modules, and application-specific (counter and communication) modules	4	1 W	BMXXBP0400H	0.630/ 1.389
		6	1.5 W	BMXXBP0600H	0.790/ 1.742
		8	2 W	BMXXBP0800H	0.950/ 2.094
		12	0.74 W	BMXXBP1200H	1.270/ 2.800
Ruggedized Ethernet + X-bus racks	BMXCPS power supply, BMEP58 processor, BMEH58 processor, I/O modules, and application-specific (counter and communication) modules	4	2.8 W	BMEXBP0400H	0.715/ 1.576
		8	3.9 W	BMEXBP0800H	1.070/ 2.359
		12	3.9 W	BMEXBP1200H	1.387/ 3.058
Ruggedized Ethernet + X-bus dual power supply racks	BMEP58 processor, BMEH58 processor, BMXCPS400● redundant power supply, I/O modules, and application-specific (counter and communication) modules	6	3.9 W	BMEXBP0602H	1.387/ 3.058
		10	3.9 W	BMEXBP1002H	1.387/ 3.058

Description	Use	Reference	Weight kg/lb
Ruggedized rack expansion module (3)	Standard module to be installed in each rack (XBE slot) Used to daisy chain up to 4 racks	BMXXBE1000H	0.178/ 0.392

(1) Number of slots taking the processor module, I/O modules, and application-specific modules (excluding power supply module).
 (2) Power consumption of anti-condensation resistor(s).
 (3) Module and cordsets do not operate properly at temperatures **lower than -25 °C/-13 °F**.

Modicon X80 modules platform

Dedicated parts for severe environments

X80 Power supplies for severe environments

X80 Power supplies for severe environments

Each **BM●XBP●●00H** rack must be equipped with a power supply. **BMEXBP●●02H** must be equipped with 1 or 2 redundant power supplies. These modules are inserted in the leftmost power supply slots of each rack (marked CPS).

The available power values given below in **bold italic** correspond to operation at $-25\text{ }^{\circ}\text{C}/-13\text{ }^{\circ}\text{F}$ and $+70\text{ }^{\circ}\text{C}/+158\text{ }^{\circ}\text{F}$ (see temperature derating curves on our website www.se.com).

The power required to supply each rack depends on the type and number of modules installed in the rack. It is therefore necessary to draw up a power consumption table for each rack in order to determine which is the most appropriate **BMXCPS●●●●H** power supply for your requirements (consult our website www.se.com).



BMXCPS3020H



BMXCPS3500H



BMXCPS4002H



BMXCPS4022H

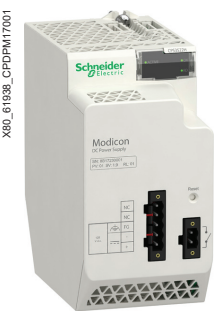

BMXCPS3522H

X80 Power supplies for severe environments (1)

Line supply	Available power (2)			Reference	Weight kg/lb
	3.3 V $\overline{\text{---}}$ (3)	24 V $\overline{\text{---}}$ rack (3)	24 V $\overline{\text{---}}$ sensors (4)		
24...48 V $\overline{\text{---}}$ isolated	15 W	32 W	–	BMXCPS3020H	0.340/ 0.750
	11.3 W	23.4 W			
100...240 V \sim	15 W	31.2 W	21.6 W	BMXCPS3500H	0.360/ 0.794
	11.3 W	23.4 W	16.2 W		
	18 W	40 W	–	BMXCPS4002H	0.360/ 0.794
	18 W	40 W			
24...48 V $\overline{\text{---}}$	18 W	40 W	–	BMXCPS4022H	0.810/ 1.786
	18 W	40 W			
125 V $\overline{\text{---}}$	18 W	40 W	–	BMXCPS3522H	0.610/ 1.345
	18 W	40 W			

(1) Includes a set of 2 removable caged connectors **BMXXTSCPS10**.

(2) The total power consumed on each voltage (3.3 V $\overline{\text{---}}$ and 24 V $\overline{\text{---}}$) must not exceed the total power of the module. See the power consumption table on our website www.se.com.

(3) 3.3 V $\overline{\text{---}}$ and 24 V $\overline{\text{---}}$ rack voltages for powering Modicon M340 and M580 PLC modules.

(4) 24 V $\overline{\text{---}}$ sensor voltage for powering the input sensors (voltage available via the 2-way removable connector on the front panel).



BMXD160H

References

X80 Discrete input modules for severe environments

Type of current	Input voltage	Connection via (1)	IEC/EN 61131-2 conformity	No. of channels (common)	Reference	Weight kg/lb		
☰	24 V (positive logic)	Caged, screw clamp, or spring-type 20-way removable terminal block	Type 3	16 isolated inputs (1 x 16)	BMXDDI1602H	0.115/0.254		
		One 40-way connector	Type 1	32 isolated inputs (2 x 16)	BMXDDI3202KH	0.110/0.243		
		Two 40-way connectors	Non-type	64 isolated inputs (4 x 16)	BMXDDI6402KH	0.145/0.320		
☰	24 V (positive/negative logic)	Caged, screw clamp, or spring-type 20-way removable terminal block	Non-type	16 isolated inputs (1 x 16)	BMXDAI1602H	0.115/0.254		
		Caged or spring-type 40-way removable terminal block	Type 3	32 isolated inputs (2 x 16)	BMXDDI3232H	0.138/0.304		
		48 V (positive logic)	Caged, screw clamp, or spring-type 20-way removable terminal block	Type 1	16 isolated inputs (1 x 16)	BMXDDI1603H	0.115/0.254	
☰	48 V (positive logic)	Caged or spring-type 40-way removable terminal block	Type 3	32 isolated inputs (2 x 16)	BMXDDI3203H	0.138/0.304		
		~	24 V	Caged, screw clamp, or spring-type 20-way removable terminal block	Type 1	16 isolated inputs (1 x 16)	BMXDAI1602H	0.115/0.254
				48 V	Caged, screw clamp, or spring-type 20-way removable terminal block	Type 3	16 isolated inputs (1 x 16)	BMXDAI1603H
100...120 V	Caged, screw clamp, or spring-type 20-way removable terminal block				Type 3	16 isolated inputs (1 x 16)	BMXDAI1604H	0.115/0.254
~	100...120 V	Caged or spring-type 40-way removable terminal block	Type 1	16 isolated inputs (1 x 16)	BMXDAI1614H	0.150/0.331		
		200...240 V	Caged or spring-type 40-way removable terminal block	Type 1	16 isolated inputs (1 x 16)	BMXDAI16142H	0.150/0.331	
			Caged or spring-type 40-way removable terminal block	Type 1	16 isolated inputs (1 x 16)	BMXDAI1615H	0.156/0.344	

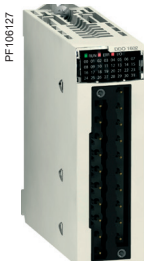

BMXDDO16H



BMXDRA0815H/0805H/1605H

X80 Discrete output modules for severe environments

Type of current	Output voltage	Connection via (1)	IEC/EN 61131-2 conformity	No. of channels (common)	Reference	Weight kg/lb
☰	24 V/0.5 A (positive logic)	Caged, screw clamp, or spring-type 20-way removable terminal block	Yes	16 protected outputs (1 x 16)	BMXDDO1602H	0.120/0.265
		Caged, screw clamp, or spring-type 20-way removable terminal block	Yes	16 protected outputs (1 x 16)	BMXDDO1612H	0.120/0.265
		One 40-way connector	Yes	32 protected outputs (2 x 16)	BMXDDO3202KC	0.110/0.243
		Two 40-way connectors	Yes	64 protected outputs (4 x 16)	BMXDDO6402KC	0.150/0.331
~	100...240 V	Caged, screw clamp, or spring-type 20-way removable terminal block	Yes	16 outputs (4 x 4)	BMXDAO1605H	0.140/0.309
		Caged or spring-type 40-way removable terminal block	Yes	16 isolated outputs	BMXDAO1615H	0.250/0.551
☰ or ~	12...24 V ☰/2 A 24...240 V ~/2 A	Caged, screw clamp, or spring-type 20-way removable terminal block	Yes	8 non-protected outputs (without common)	BMXDRA0805H	0.145/0.320
		Caged, screw clamp, or spring-type 20-way removable terminal block	Yes	8 normally open isolated relay outputs	BMXDRA0815H	0.210/0.463
		Caged, screw clamp, or spring-type 20-way removable terminal block	Yes	16 non-protected outputs (2 x 8)	BMXDRA1605H	0.150/0.331
		Caged or spring-type 40-way removable terminal block	Yes	8 normally open/ normally closed isolated relay outputs	BMXDRC0805H	0.189/0.417

X80 Mixed discrete I/O modules for severe environments

Number of I/O	Connection via (1)	No. of input channels (common)	No. of output channels (common)	IEC/EN 61131-2 conformity	Reference	Weight kg/lb
16	Caged, screw clamp, or spring-type 20-way removable terminal block	8 (positive logic) (1 x 8)	8, transistor 24 V ☰ /0.5 A (1 x 8)	Inputs, type 3	BMXDDM16022H	0.115/0.254
			8, 24 V ☰ or 24...240 V ~ relay (1 x 8)	Inputs, type 3	BMXDDM16025H	0.135/0.298

(1) By connector, module supplied with cover(s)



BMXDDM1602H

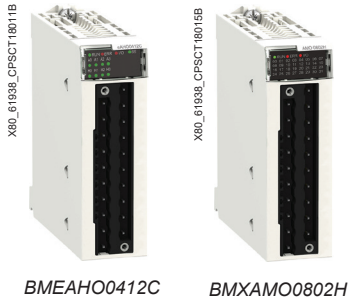
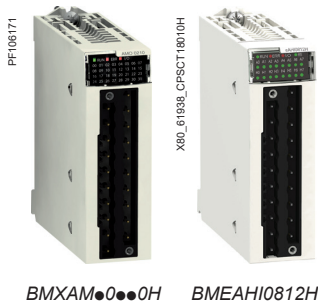

References

X80 Analog input modules for severe environments

Type of inputs	Input signal range	Resolution	Connection	No. of channels	Reference	Weight kg/lb
Isolated high-level inputs	± 10 V, 0...10 V, 0...5 V, 1...5 V, ± 5 V 0...20 mA, 4...20 mA, ± 20 mA	16 bits	Caged, screw clamp, or spring-type 20-way removable terminal block	4 high-speed channels	BMXAMI0410H	0.143/ 0.315
			Caged, screw clamp, or spring-type 28-way removable terminal block	8 isolated high-speed channels	BMXAMI0810H	0.175/ 0.386
	4...20 mA	15 bits + sign	Caged, screw clamp, or spring-type 20-way removable terminal block	8 isolated high-speed channels	BMEAH0812H	0.233/ 0.514
Isolated low-level inputs	Temperature probe, thermocouple ± 40 mV, ± 80 mV, ± 160 mV, ± 320 mV, ± 640 mV, ± 1.28 V	15 bits + sign	40-way connector	4 channels	BMXART0414H	0.135/ 0.298
				8 channels	BMXART0814H	0.165/ 0.364

X80 Analog output module for severe environments

Type of outputs	Output signal range	Resolution	Connection	No. of channels	Reference	Weight kg/lb
Isolated high-level outputs	± 10 V, 0...20 mA, 4...20 mA	16 bits	Caged, screw clamp, or spring-type 20-way removable terminal block	2 channels	BMXAMO0210H	0.144/ 0.317
				4 channels	BMXAMO0410H	0.175/ 0.386
	4...20 mA	15 bits + sign	Caged, screw clamp, or spring-type 20-way removable terminal block	4 channels	BMEAH00412C	0.223/ 0.492
Non-isolated high-level outputs	0...20 mA, 4...20 mA	15 bits + sign	Caged, screw clamp, or spring-type 20-way removable terminal block	8 channels	BMXAMO0802H	0.150/ 0.331

X80 Mixed analog I/O module for severe environments

Type of outputs	Signal range	Resolution	Connection	No. of channels	Reference	Weight kg/lb
Mixed I/O, non-isolated	± 10 V, 0...10 V, 0...5 V, 1...5 V, ± 5 V, 0...20 mA, 4...20 mA	14 bits or 12 bits depending on the range	Caged, screw clamp, or spring-type 20-way removable terminal block	I: 4 channels Q: 2 channels	BMXAMM0600H	0.155/ 0.342



BMXEHC0200H



BMXEHC0800H



BMXERT1604H



BMXEAE0300H

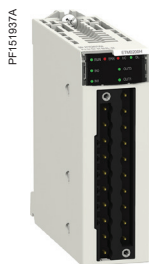

BMXETM0200H

References

X80 Counter modules for severe environments

Description	No. of channels	Characteristics	Reference	Weight kg/lb
Counter modules for 24 V $\overline{\text{DC}}$ 2- and 3-wire sensors and 10/30 V $\overline{\text{DC}}$ incremental encoders with push-pull outputs	2	60 kHz counting	BMXEHC0200H	0.112 0.247
	8	10 kHz counting	BMXEHC0800H	0.113 0.249

X80 Time-stamping module for severe environments

Description	No. of channels	Characteristics	Reference	Weight kg/lb
Multifunction time-stamping input module	16	Time- and date-stamping at 1 ms 1.6 < resolution < 3.3 ms store up to local 4000 events (255 groups, each group 16 channel) (1) 16 discrete inputs on module	BMXERT1604H	0.119/ 0.262

X80 SSI encoder interface module for severe environments

Description	No. of channels	Characteristics	Reference	Weight kg/lb
SSI encoder interface module	3	8- to 31-bit data width 4 baud rates: 100 kHz, 200 kHz, 500 kHz, 1 MHz	BMXEAE0300H	0.138/ 0.304

X80 Frequency input module for severe environments

Description	No. of channels	Characteristics	Reference	Weight kg/lb
Speed and frequency control module for turbomachinery application	2	Input frequency: 0...500Hz, reflex digital output	BMXETM0200H	0.124/ 0.273

(1) This maximum value is not an absolute value. It depends on the overall system dynamics (total number of scanned items and number of events generated by the system).

(2) The shielding on the cordsets carrying the counter signals must always be connected to the **BMXXSP●●00** shielding connection kit mounted under the rack holding the **BMXEHC0200H** module (see [page 2/3](#)).

Modicon X80 modules platform

Dedicated parts for severe environments
X80 I/O expansion modules, communication modules,
and gateway for severe environments



BMECRA31210C



BMXCRA31210C



PMEPXM0100H



BMXNRP020C



BMENOS0300C

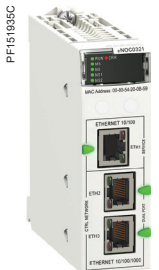

BMEXCM0100H



TCSEGPA23F14FK

References

X80 I/O expansion modules with conformal coating

Description	SERVICE port	Reference	Weight kg/lb
Drop adapter for Ethernet + X-bus racks	1	BMECRA31210C	–
Performance drop adapter	1	BMXCRA31210C	–

X80 Serial link module for severe environments

Description	Protocol	Physical layer	Reference	Weight kg/lb
Serial link module (2 channels)	Modbus client/server	1 non-isolated RS 232 channel (SL0)	BMXNOM0200H	0.230/
	RTU/ASCII, Character mode, GSM/GPRS modem	2 isolated RS 485 channels (SL0 and SL1)		0.507

X80 CANopen client module for severe environments

Description	Protocols	Physical layer	Reference	Weight kg/lb
CANopen communication module	CiA 301 V4.2 standard (client or server); Ethernet/IP	ISO 11898 (9-way SUB-D connector)	BMECXM0100H	0.200/0.441

X80 PROFIBUS DP module for severe environments

Description	Protocols	Physical layer	Reference	Weight kg/lb
X80 Profibus DP Master module	Implicit exchange of process data	EIA-485 (optical, MBP)	PMEPXM0100H	0.270/0.595

X80 PROFIBUS DP network gateway for severe environments

Description	Protocols	Physical layer	Reference	Weight kg/lb
Profibus Remote Master (PRM) module	Modbus TCP	1 Ethernet switch, 2 ports 10BASE-T/100BASE-TX	TCSEGPA23F14FK	–
	Profibus DP V1 and Profibus PA (via gateway)	1 isolated RS 485 Profibus DP port		

X80 Fiber converter modules for severe environments

Description	Optical fiber	Reference	Weight kg/lb
EIO drop fiber optic repeaters	Multimode	BMXNRP0200C	–
	Single-mode	BMXNRP0201C	–

X80 Ethernet switch module with conformal coating

Description	SERVICE port	Device network port(Ethernet)	Weight kg/lb
Ethernet switch module with conformal coating	1	2	BMENOS0300C

Connection accessory

Designation	Description	RS 232 interface	Reference	Weight kg/lb
Cordset for DCE terminal (modem, etc.)	Equipped with 1 x RJ45 connector and 1 x 9-way male SUB-D connector Length 3 m/9.84 ft	Simplified 4-wire (RX, TX, RTS, and CTS)	TCSMCN3M4M3S2	0.150/0.331
		Full 8-wire (except RI signal)	TCSXCN3M4F3S4	0.165/0.364

(1) Not implemented yet.

(2) On backplane port.

(3) Requires Unity Pro Extra Large software ≥ V7.0; see our website www.se.com.

(4) Supports operation at -25 to 60°C / -13 to 140°F.

10 - Standards and certifications, index

Technical appendices

- Standards, certifications, and environmental conditions [page 10/2](#)
- Per region [page 10/2](#)
- Per segment [page 10/2](#)
- Environmental characteristics [page 10/3](#)
- Protective treatment of the Modicon X80 modules platform [page 10/3](#)
- Environment tests [page 10/4](#)
- Certifications for automation products and EC regulations [page 10/8](#)

Index

- Product reference index [page 10/10](#)



Standards and certifications

Per region

The Modicon X80 modules platform has been developed to comply with the principal national and international standards concerning electronic equipment for industrial automation systems. Up-to-date information on which certifications have been obtained is available on our website: consult commercial references directly.

- Compliance with European Directives for CE marking:
 - WEEE: 2012/19/EU
 - Low voltage: 2014/35/EU
 - Electromagnetic compatibility: 2014/30/EU
 - Machinery: 2006/42/EC (check EU DoC on our website www.se.com)
 - ATEX: 2014/34/EU (check EU DoC on our website www.se.com)
- Requirements specific to programmable controllers (functional characteristics, immunity, resistance, safety, etc.):
 - IEC/EN 61131-2
 - IEC/EN/UL/CSA 61010-2-201
- Country specific passport:
 - RCM
 - EAC
 - KC

For other countries certifications, please refer to technical appendix page X0016/2.

The X80 modules platform is considered as open equipment and is designed for use in industrial environments, in pollution degree 2, overvoltage category II (IEC 60664-1), and in low-voltage installations, where the main power branch is protected on both wires by devices such as fuses or circuit breakers limiting the current to 15A for North America and 16A for the rest of the world.

Per segment

Power generation

- IEC/EN 61000-6-5 for interfaces type 1 and 2
- IEC/EN 61850-3 for locations G

Merchant navy

Merchant navy requirements of the major international organizations are unified in IACS (International Association of Classification Societies) IACS E10 rules: BV, DNV-GL, ABS, LR, RINA (refer to page X0016/2).

Hazardous areas

- For USA and Canada: Hazardous location class I, division 2, groups A,B,C, and D
- For European Union: ATEX for atmosphere Zone 2 (gas) and Zone 22 (dust)
- For other countries: IECEx for atmosphere Zone 2 (gas) and/or Zone 22 (dust)

Functional safety

All Safety modules are certified by TÜV Rheinland.

The certificate reviews the following standards:

- **Functional safety**
 - IEC/EN 61508: Functional safety of electrical/electronic/programmable electronic safety-related systems
 - IEC/EN 61508-1 - Part 1: General requirements
 - IEC/EN 61508-2 - Part 2: Requirements for electrical/electronic/programmable electronic safety-related systems
 - IEC/EN 61508-3 - Part 3: Software requirements
- **Process safety**
 - IEC/EN 61511: Functional safety - Safety instrumented systems for the process industry sector
 - IEC/EN 61511-1 - Part 1: Framework, definitions, system, hardware and software requirements
 - IEC/EN 61511-2 - Part 2: Guidelines for the application of IEC 61511-1
 - IEC/EN 61511-3 - Part 3: Guidance for the determination of the required safety integrity levels
- **Machine safety**
 - IEC/EN 62061: Safety of machinery - Functional safety of safety-related electrical, electronic and programmable electronic control systems
 - ISO/EN 13849-1: Safety of machinery - Safety-related parts of control systems - Part 1: General principles for design
 - ISO/EN 13849-2: Safety-related parts of control systems - Part 2: Validation



Standards and certifications

Per segment (continued)

Fire & Gas

- EN 54.2 Fire detection and fire alarms systems – Part 2: Control and indicating equipment
- EN 50156-1 Electrical equipment for furnaces and ancillary equipment - Part 1: Requirements for application design and installation
- EN 50130-4 Immunity requirements components of fire, intruder, holdup, CCTV, access control and social alarms systems
- EN 298 Automatic burner control systems for burners and appliances burning gaseous or liquid fuels
- NFPA 85 Boiler and Combustion Systems Hazards Code
- NFPA 86 Standard for Ovens and Furnaces
- NFPA 72 National Fire Alarm and Signaling Code

Railway

- EN 50155/IEC 60571: Railway applications - Rolling stock - Electronic equipment
- EN 50121-3-2/IEC 62236-3-2: Railway applications - Electromagnetic compatibility - Part 3-2: Rolling stock - Apparatus
- EN 50121-4/IEC 62236-4: Railway applications - Electromagnetic compatibility - Part 4: Emission and immunity of the signalling and telecommunications apparatus
- EN 50121-5/IEC 62236-5: Railway applications - Electromagnetic compatibility - Part 5: Emission and immunity of fixed power supply installations and apparatus

Environmental characteristics

Service conditions and recommendations relating to the environment

			Modicon X80 modules platform	Modicon M580 Safety platform	Modicon X80 modules for severe environments		
Temperature	Operation	°C/°F	0...+60/32...140	-25...+60/-13...+140	-25...+70/-13...+158		
	Storage	°C/°F	-40...+85/-40...+185	-40...+85/-40...+185	-40...+85/-40...+185		
Relative humidity (without condensation)	Cyclical humidity	%	+5 ... +95 up to 55 °C/131 °F	+5...+95 up to 55 °C/131 °F	+5 ... +95 up to 55 °C/131 °F		
	Continuous humidity	%	+5 ... +93 up to 55 °C/131 °F	+5...+93 up to 60 °C/140 °F	+5 ... +93 up to 60 °C/140 °F		
Altitude	Operation	m/ft	0...2,000/0...6,562 (full specification: temperature and isolation) 2,000...5,000/6,562...16,404 (temperature derating: approx. 1 °C/400 m (33.8 °F/1,312 ft), isolation 150 V/1,000 m/3,281 ft For accurate temperature derating calculation, refer to IEC 61131-2 Ed4.0 Annex A				
Supply voltage			Modicon X80 power supplies				
			BMXCPS2010	BMXCPS3020 BMXCPS3020H	BMXCPS3540T BMXCPS3522 BMXCPS3522S	BMXCPS2000	BMXCPS3500 BMXCPS3500H BMXCPS4002 BMXCPS4002S BMXCPS4002H BMXCPS4022S
	Nominal voltage	V	24 ---	24...48 ---	125 ---	100...240 ~	100...240 ~
	Limit voltages	V	18...31.2 ---	18...62.4 ---	100...150 ---	85...264 ~	85...264 ~
	Nominal frequencies	Hz	–	–	–	50/60	50/60
Limit frequencies	Hz	–	–	–	47/63	47/63	

Protective treatment of the Modicon X80 modules platform

The Modicon X80 modules platform meets the requirements of “TC” treatment (treatment for all climates).

For installations in industrial production workshops or environments corresponding to “TH” treatment (treatment for hot and humid environments), Modicon X80 modules platform must be embedded in enclosures with minimum IP54 protection.

The Modicon X80 modules platform offers **protection to IP20 level and protection against access to terminals** (enclosed equipment) (1). They can therefore be installed without an enclosure in reserved-access areas that do not exceed **pollution level 2** (control room with no dust-producing machine or activity). Pollution level 2 does not take account of more severe environmental conditions: air pollution by dust, smoke, corrosive or radioactive particles, vapors or salts, molds, insects, etc.

(1) In cases where a slot is not occupied by a module, a BMXXEM010 protective cover must be installed.

(C€): Tests required by European directives (C€) and based on IEC/EN 61131-2 standards.



BMXXEM010 protective cover

Environment tests		
Name of test	Standards	Levels
Immunity to LF interference (CE) (1)		
Voltage and frequency variations	IEC/EN 61131-2; IEC/EN 61000-6-2; IEC 61000-4-11 IACS E10; IEC 61000-4-11	0.85...1.10 Un - 0.94...1.04 Fn; 4 steps t = 30 min 0.80 Un...0.90 Fn; 1.20 Un...1.10 Fn; t = 1.5 s/5 s
Direct voltage variations	IEC/EN 61131-2; IEC 61000-4-29; IACS E10 (PLC not connected to charging battery)	0.85...1.2 Un + ripple: 5% peak; 2 steps t = 30 min
Third harmonic	IEC/EN 61131-2	H3 (10% Un), 0°/180°; 2 steps t = 5 min
Immunity to conducted low frequency (only IACS)	IACS E10	For ~ : ■ H2...H15 (10% Un), H15...H100 (10%...1% Un), H100...H200 (1% Un) For --- : ■ H2...H200 (10% Un)
Voltage interruptions	IEC/EN 61131-2; IEC/EN 61000-6-2; IEC 61000-4-11; IEC 61000-4-29; IACS E10 For functional safety (DS criteria): IEC 61000-6-7; IEC 61326-3-1	Power supply immunity: ■ 1 ms for --- PS1/10 ms for ~ PS2 (20 ms DS criteria), 85% Un ■ Check operating mode for longer interruptions ■ up to 5s, 85% Un ■ for IACS, 3 times 30 s in 5 min, 85% Un
	IEC/EN 61131-2; IEC/EN 61000-6-2; IEC 61000-4-11	For ~ PS2: ■ 20% Un, t0: ½ period ■ 40% Un, cycle 10/12 ■ 70% Un, cycle: 25/30 ■ 0% Un, cycle 250/300
Voltage shut-down and start-up	IEC/EN 61131-2	■ Un...0...Un; t = Un/60 s ■ Umin...0...Umin; t = Umin/5 s ■ Umin...0.9 Udl...Umin; t = Umin/60 s
Magnetic field	IEC/EN 61131-2; IEC 61000-4-8; IEC 61000-6-5; IEC 61850-3 For functional safety (DS criteria): IEC 61000-6-7; IEC 61326-3-1 IEC 61000-4-10	Power frequency: 50/60 Hz, 100 A/m continuous ...1000 A/m; t = 3 s; 3 axes Oscillatory: 100 kHz...1 MHz, 100 A/m; t = 9 s; 3 axes
Conducted common mode disturbances range 0 Hz ...150 kHz	IEC 61000-4-16 IEC 61000-6-5; IEC 61850-3 For functional safety (DS criteria): IEC 61000-6-7; IEC 61326-3-1	For remote systems: ■ 50/60 Hz and ---, 300 V, t = 1 s ■ 50/60 Hz and ---, 30 V, t = 1 min ■ 5 Hz...150 kHz, sweep 3 V...30 V ■ For AC: 10 V ■ For DC: 10 V cont. or 100 V, t = 1 s

Where:

- PS1 applies to PLC supplied by battery, PS2 applies to PLC energized from ~ or --- supplies
- Un: nominal voltage, Fn: nominal frequency, Udl: detection level when powered

(1) Devices must be installed, wired, and maintained in accordance with the instructions provided in the manual "Grounding and Electromagnetic Compatibility of PLC Systems".

(2) These tests are performed without an enclosure, with devices fixed on a metal grid and wired as per the recommendations in the manual "Grounding and Electromagnetic Compatibility of PLC systems".

(CE): Tests required by European CE directives and based on IEC/EN 61131-2.

Environment tests (continued)		
Name of test	Standards	Levels
Immunity to HF interference (CE) (1)		
Electrostatic discharges	IEC/EN 61131-2; IEC/EN 61000-6-2; IEC 61000-6-5; IEC 61850-3; IEC 61000-4-2; IACS E10 For functional safety (DS criteria): IEC 61000-6-7; IEC 61326-3-1	6 kV contact; 8 kV air; 6 kV indirect contact
Radiated radio frequency electromagnetic field	IEC/EN 61131-2; IEC/EN 61000-6-2; IEC 61000-6-5; IEC 61850-3; IEC 61000-4-3; IACS E10 For functional safety (DS criteria): IEC 61000-6-7; IEC 61326-3-1	80MHz...1GHz: 10/15 V/m (20 V/m DS criteria); 3 V/m, 1.4 GHz...2 GHz: 3V/m (10 V/m DS criteria) 2 GHz...6 GHz: 3V/m Sinus amplitude modulated 80%, 1 kHz + internal clock frequencies
Electrical fast transient bursts	IEC/EN 61131-2; IEC/EN 61000-6-2; IEC 61000-6-5; IEC 61850-3; IEC 61000-4-4; IACS E10 For functional safety (DS criteria): IEC 61000-6-7; IEC 61326-3-1	For ~ or --- main supplies: ■ 2 kV in common mode/2 kV in wire mode (4 kV DS criteria with external protection) For ~ or --- auxiliary supplies, ~ unshielded I/O: ■ 2 kV in common mode For analog, --- unshielded I/O, communication and shielded lines: ■ 1 kV in common mode (3 kV DS criteria)
Surge	IEC/EN 61131-2; IEC/EN 61000-6-2; IEC 61000-6-5; IEC 61850-3; IEC 61000-4-5; IACS E10 For functional safety (DS criteria): IEC 61000-6-7; IEC 61326-3-1	For ~/--- main and auxiliary supplies, ~ unshielded I/O: ■ 2 kV in common mode/1 kV in differential mode (4 kV DS criteria with external protection) For analog, --- unshielded I/O: ■ 2 kV in common mode/2 kV in differential mode For communication and shielded lines: ■ 1 kV in common mode (3 kV DS criteria)
Conducted disturbances induced by radiated electromagnetic fields	IEC/EN 61131-2; IEC/EN 61000-6-2; IEC 61000-6-5; IEC 61850-3; IEC 61000-4-6; IACS E10 For functional safety (DS criteria): IEC 61000-6-7; IEC 61326-3-1	10 V; 0.15 MHz...80 MHz (20 V DS criteria) Sinus amplitude 80%, 1 kHz + spot frequencies
Damped oscillatory wave	IEC/EN 61131-2; IEC 61000-6-5; IEC 61850-3; IEC 61000-4-18; IACS E10	For ~/--- main supplies and ~ auxiliary supplies, ~ unshielded I/O: ■ 2.5 kV in common mode/1 kV in differential mode For --- auxiliary supplies, analog, --- unshielded I/O: ■ 1 kV in common mode/0.5 kV in differential mode For communication and shielded lines: ■ 0.5 kV in common mode

(1) Devices must be installed, wired, and maintained in accordance with the instructions provided in the manual "Grounding and Electromagnetic Compatibility of PLC Systems".

(2) These tests are performed without an enclosure, with devices fixed on a metal grid and wired as per the recommendations in the manual "Grounding and Electromagnetic Compatibility of PLC systems".

(CE): Tests required by European CE directives and based on IEC/EN 61131-2.

Environment tests (continued)		
Name of test	Standards	Levels
Electromagnetic emissions (CE) (1)		
Conducted emissions	IEC/EN 61131-2; IEC/EN 61000-6-4; CISPR 11 & 22, Class A, Group 1	150 kHz ... 500 kHz: quasi-peak 79 dB (µV/m); average 66 dB (µV/m) 500 kHz ... 30 MHz: quasi-peak 73 dB (µV/m); average 60 dB (µV/m)
	IACS E10	<ul style="list-style-type: none"> ■ ~ power (general power distribution zone): 10 kHz ... 150 kHz: quasi-peak 120...69 dB (µV/m); 150 kHz ... 0.5 MHz: quasi-peak 79 dB (µV/m) 0.5 MHz ... 30 MHz: quasi-peak 73 dB (µV/m) ■ ~ power (bridge and deck zone for evaluation): 10 kHz ... 150 kHz: quasi-peak 96...50 dB (µV/m) 150 kHz ... 0.35 MHz: quasi-peak 60...50 dB (µV/m) 0.35 MHz ... 30 MHz: quasi-peak 50 dB (µV/m)
Radiated emissions	IEC/EN 61131-2; IEC/EN 61000-6-4; CISPR 11 & 22, Class A, Group 1	30 MHz ... 230 MHz: quasi-peak 40 dB (µV/m) (at 10 m/33 ft) 230 MHz ... 1 GHz: quasi-peak 47 dB (µV/m) (at 10 m/33 ft) 1 GHz ... 3 GHz: quasi-peak 76 dB (µV/m) (at 3 m/9.84 ft) 3 GHz ... 6 GHz: quasi-peak 80 dB (µV/m) (at 3 m/9.84 ft)
	IACS E10	<ul style="list-style-type: none"> ■ For general power distribution zone 0.15 MHz ... 30 Mhz: quasi-peak 80...50 dB (µV/m) (at 3 m/9.84 ft) 30 MHz-100 MHz: quasi-peak 60...54 dB (µV/m) (at 3 m/9.84 ft) 100 MHz - 2 GHz: quasi-peak 54 dB (µV/m) (at 3 m/9.84 ft) 156 ... 165 MHz: quasi-peak 24 dB (µV/m) (at 3 m/9.84 ft)
Name of test		
Standards		
Levels		
Immunity to climatic variations (1) (power on)		
Dry heat	IEC 60068-2-2 (Bb & Bd)	60 °C/140 °F, t = 16 hrs [for ruggedized range: 70 °C/158 °F, t = 16 hrs] (2)
	IACS E10	70 °C/140 °F, t = 16 hrs
Cold	IEC 60068-2-1 (Ab & Ad) IACS E10	0 °C... -25 °C/32 °F...-13 °F, t = 16 hrs + power on at 0 °C/ 32 °F [for ruggedized range: power on at -25 °C/-13 °F] (2)
Damp heat, steady state (continuous humidity)	IEC 60068-2-78 (Cab); IACS E10	55 °C/131 °F, 93% relative humidity, t = 96 hrs [for ruggedized range: 60 °C/140 °F] (2)
Damp heat, cyclic (cyclical humidity)	IEC 60068-2-30 (Db); IACS E10	55 °C...25 °C/131 °F...77 °F, 93...95% relative humidity, 2 cycles t = 12 hrs +12 hrs
Change of temperature	IEC 60068-2-14 (Nb)	0 °C ... 60 °C/32 °F...140 °F, 5 cycles t = 6 hrs + 6 hrs [for ruggedized range: -25 °C...70 °C/-13 °F...158 °F] (2)
Name of test		
Standards		
Levels		
Withstand to climatic variations (1) (power off)		
Dry heat	IEC/EN 61131-2; IEC 60068-2-2 (Bb & Bd) IEC/EN 60945	85 °C/185 °F, t = 96 hrs
Cold	IEC/EN 61131-2; IEC 60068-2-1 (Ab & Ad); IACS E10	-40 °C/-40 °F, t = 96 hrs
Damp heat, cyclic (cyclical humidity)	IEC/EN 61131-2; IEC 60068-2-30 (Db)	55 °C...25 °C/77 °F...131 °F, 93...95% relative humidity, 2 cycles t = 12 hrs + 12 hrs
Change of temperature (thermal shocks)	IEC/EN 61131-2; IEC 60068-2-14 (Na)	-40 °C...85 °C/-40 °F...185 °F, 5 cycles t = 3 hrs + 3 hrs

(1) Devices must be installed, wired, and maintained in accordance with the instructions provided in the manual "Grounding and Electromagnetic Compatibility of PLC Systems".

(2) Refer also to the section "Treatment for severe environments".

(CE): Tests required by European CE directives and based on IEC/EN 61131-2 standards.

Environment tests (continued)		
Name of test	Standards	Levels
Immunity to mechanical constraints (1) (power on)		
Sinusoidal vibrations	IEC/EN 61131-2; IEC 60068-2-6 (Fc)	Basic IEC/EN 61131-2: 5 Hz ... 150 Hz, ± 3.5 mm/0.14 in. amplitude (5 Hz ... 8.4 Hz), 1 g (8.4 Hz ... 150 Hz) Specific profile: 5 Hz ... 150 Hz, ± 10.4 mm/0.41 in. amplitude (5 Hz ... 8.4 Hz), 3 g (8.4 Hz ... 150 Hz) For basic and specific: endurance: 10 sweep cycles for each axis
	IEC 60870-2-2 ; IEC 60068-2-6 (Class Cm)	2 Hz ... 500 Hz, 7 mm/0.28 in. amplitude (2 Hz ... 9 Hz), 2 g (9 Hz ... 200 Hz), 1.5 g (200 Hz ... 500 Hz) endurance: 10 sweep cycles for each axis
	IACS E10	3 Hz ... 100 Hz, 1 mm/0.04 in. amplitude (3 Hz ... 13.2 Hz), 0.7 g (13.2 Hz ... 100 Hz) Endurance at each resonance frequency: 90 min for each axis, amplification coefficient < 10
	IEC 60068-2-6	Seismic analysis: 3 Hz ... 35 Hz, 22.5 mm/0.89 in. amplitude (3 Hz ... 8.1 Hz), 6 g (8.1 Hz ... 35 Hz)
Shock	IEC/EN 61131-2; IEC 60068-2-27 (Ea)	30 g, 11 ms; 3 shocks/direction/axis (2) For M580 Safety: 15 g, 11 ms; 3 shocks/direction/axis 25 g, 6 ms; 100 bumps/direction/axis (bumps) (3)
Free fall during operation	IEC/EN 61131-2; IEC 60068-2-32 (Ed Method 1)	1 m/3.28 ft, 2 falls
Name of test Standards Levels		
Withstand to mechanical constraints (power off)		
Random free fall with packaging	IEC/EN 61131-2; IEC 60068-2-32 (Method 1)	1 m/3.28 ft, 5 falls
Flat free fall	IEC/EN 61131-2; IEC 60068-2-32 (Ed Method 1)	10 cm/0.33 ft, 2 falls
Controlled free fall	IEC/EN 61131-2; IEC 60068-2-31 (Ec)	30° or 10 cm/0.33 ft, 2 falls
Plugging/Unplugging	IEC/EN 61131-2	For modules and connectors: Operations: 50 for permanent connections, 500 for non-permanent connections
Name of test Standards Levels		
Equipment and personnel safety (1) (CE)		
Dielectric strength and insulation resistance	IEC/EN 61131-2; IEC 61010-2-201; UL; CSA	Dielectric: 2 Un + 1000 V; t = 1 min Insulation: Un ≤ 50 V: 10 MΩ, 50 V ≤ Un ≤ 250 V : 100 MΩ
Ground continuity	IEC/EN 61131-2; IEC 61010-2-201; UL; CSA	30A, R ≤ 0,1Ω; t = 2 min
Leakage current	IEC/EN 61131-2; IEC 61010-2-201; UL; CSA	≤ 0.5 mA in normal condition ≤ 3.5 mA in single fault condition
Protection offered by enclosures	IEC/EN 61131-2; IEC61010-2-201;	IP20 and protection against standardized pins
Impact withstand	IEC/EN 61131-2; IEC 61010-2-201; UL; CSA	Sphere of 500 g, fall from 1.3 m/4.27 ft (energy 6.8 J minimum)
Overload	IEC/EN 61131-2; IEC 61010-2-201; UL; CSA	50 cycles, Un, 1.5 In; t = 1 s ON + 9 s OFF
Endurance	IEC/EN 61131-2; IEC 61010-2-201; UL; CSA	In, Un; 6,000 cycles: t = 1 s ON + 9 s OFF
Temperature rise	IEC/EN 61131-2; UL; CSA; ATEX; IECEx	Ambient temperature 60 °C/140 °F [for ruggedized range: 70 °C/158 °F] (4)
Name of test Standards Levels		
Specific environment (4)		
Corrosion areas - gas, salt, dust	ISA S71.4	Flowing mixed gas; class Gx, 25 °C/77 °F, 75% relative humidity, t = 14 days
	IEC/EN 60721-3-3 IEC60068-2-60	Flowing mixed gas; class 3C3, 25 °C/77 °F, 75% relative humidity, t = 14 days
	IEC/EN 60721-3-3 IEC60068-2-60	Flowing mixed gas; class 3C4, 25 °C/77 °F, 75% relative humidity, t = 7 days
	IEC60068-2-52	Salt spray: test Kb, severity 2
	IEC/EN 60721-3-3 IEC60068-2-68	Dust and sand, Arizona dust, class 3S4, 20 cycles
	IEC/EN 60721-3-3 IEC60068-2-10	Mold growth, fungal spore, class 3B2, t=28 days

(1) Devices must be installed, wired, and maintained in accordance with the instructions provided in the manual "Grounding and Electromagnetic Compatibility of PLC Systems".

(2) When using fast actuators (response time ≤ 5 ms) driven by relay outputs: 15 g, 11 ms; 3 shocks/direction/axis.

(3) When using fast actuators (response time ≤ 15 ms) driven by relay outputs: 15 g, 6 ms; 100 bumps/direction/axis.

(4) Refer also to the section "Treatment for severe environments".

(CE): Tests required by European CE directives and based on IEC/EN 61131-2 standards.

Technical appendices

Automation product certifications

EC regulations

Some countries require certain electrical components to undergo certification by law. This certification takes the form of a certificate of conformity to the relevant standards and is issued by the official body in question. Where applicable, certified devices must be labeled accordingly. Use of electrical equipment on board merchant vessels generally implies that it has gained prior approval (i.e. certification) by certain shipping classification societies.

Abbreviation	Certification body	Country
CSA	Canadian Standards Association	Canada
RCM	Australian Communications and Media Authority	Australia, New Zealand
EAC	Eurasian conformity	Russia and customs union
UL	Underwriters Laboratories	USA







Abbreviation	Classification authority	Country
IACS	International Association of Classification Societies	International
ABS	American Bureau of Shipping	USA
BV	Bureau Veritas	France
DNV-GL	Det Norske Veritas / Germanischer Lloyd	Norway / Germany
LR	Lloyd's Register	UK
RINA	Registro Italiano Navale	Italy
RMRS	Russian Maritime Register of Shipping	Russia
RRR	Russian River Register	Russia
CCS	China Classification Society	China
KRS	Korean Register of Shipping	Korea
Class NK	Nippon Kaiji Kyokai	Japan

Note: Following the merger of the DNV and GL certification bodies, DNV/GL has been issued as a single certificate since 2016.

The following tables provide an overview of the situation as of December 2018, in terms of which certifications (listed next to their respective bodies) have been granted or are pending for our automation products.

Up-to-date information on which certifications have been obtained by products bearing the Schneider Electric brand can be viewed on our website: www.se.com

Product certifications

Certified Certification pending	Certifications						
	 UL USA	 CSA Canada	 RCM Australia	 EAC Russia	 Hazardous locations (1) UL - CSA USA, Canada	 ATEX - IECEx	 TÜV Rheinland
Modicon STB					Cl. I, Div. 2, Grps ABCD	Zone 2 (2) (4)	
Modicon Telefast ABE 7							
ConneXium					Cl. I, Div. 2, Grps ABCD (2)		
Modicon Switch							
Harmony iPC/GTW		(3)		(2)	Cl. I, Div. 2, Grps ABCD	Zone 2/22 (2)	
Magelis XBT GT		(3)		(2)	Cl. I, Div. 2, Grps ABCD (2)	Zone 2/22 (2) (4) (5)	
Magelis XBT GK		(3)			Cl. I, Div. 2, Grps ABCD		
Magelis XBT N/R/RT					Cl. I, Div. 2, Grps ABCD	Zone 2/22 (2) (4)(5)	
Harmony HMI GTO		(3)		(2)	Cl. I, Div. 2, Grps ABCD	Zone 2/22 (2) (5)	
Harmony HMI STO/STU		(3)		(2)	Cl. I, Div. 2, Grps ABCD (2)	Zone 2/22 (2) (5)	
Modicon MC80					Cl. I, Div. 2, Grps ABCD		
Modicon M340					Cl. I, Div. 2, Grps ABCD	Zone 2/22 (2) (5)	
Modicon M580					Cl. I, Div. 2, Grps ABCD	Zone 2/22 (2) (5)	
Modicon M580 Safety					Cl. I, Div. 2, Grps ABCD	Zone 2/22 (2) (5)	SIL 3, Cat.4, PLe
Modicon X80					Cl. I, Div. 2, Grps ABCD	Zone 2/22 (2) (5)	
Modicon Momentum					Cl. I, Div. 2, Grps ABCD		
Modicon Premium				(2)	Cl. I, Div. 2, Grps ABCD		
Modicon Quantum				(2)	Cl. I, Div. 2, Grps ABCD	Zone 2/22 (2) (5)	
Modicon Quantum Safety				(2)	Cl. I, Div. 2, Grps ABCD	Zone 2/22 (2) (5)	SIL 2, SIL 3 (6)
Modicon TSX Micro					Cl. I, Div. 2, Grps ABCD		

(1) Refer to user manual for installation in hazardous locations.

(2) Depends on product; Refer to the product certificates at www.se.com.

(3) North American certification cULus (Canada and USA).

(4) For zones not covered by this specification, Schneider Electric offers a solution as part of the TPP (Technology Partner Program). Please contact our Customer Care Center.

(5) Certified by INERIS. Refer to the instructions supplied with each ATEX and/or IECEx certified product.











(6) According to IEC 61508. Certified by TÜV Rheinland for integration into a safety function of up to SIL 2 or SIL 3.

Technical appendices

Automation product certifications

EC regulations

Merchant navy certifications

Certified Certification pending	Shipping classification societies										
											
	USA	France	Norway	Germany	Korea	Great Britain	Italy	Russia	Russia	China	Japan
Modicon STB											
Modicon Telefast ABE 7											
ConneXium											
Modicon Switch											
Harmony iPC/GTW											
Magelis XBT GT											
Magelis XBT GK											
Magelis XBT N/R											
Magelis XBT RT											
Harmony HMI GTO											
Harmony HMI STO/STU											
Modicon MC80											
Modicon M340											
Modicon M580											
Modicon M580 Safety											
Modicon X80											
Modicon Momentum											
Modicon Premium											
Modicon Quantum											
Modicon TSX Micro											

EC regulations

European Directives

The open nature of the European markets assumes harmonization between the regulations set by the member states of the European Union. European Directives are texts intended to remove restrictions on free circulation of goods and must be applied within all European Union states.

Member states are obligated to incorporate each Directive into their national legislation, and to simultaneously withdraw any regulations that contradict it.

Directives - and particularly those of a technical nature with which we are concerned - merely set out the objectives to be fulfilled (referred to as "essential requirements"). Manufacturers are responsible for taking the necessary measures to establish that their products conform to the requirements of each Directive applicable to their equipment.

As a general rule, manufacturers certify compliance with the essential requirements of the Directive(s) that apply to their products by applying a CE mark. The CE mark is affixed to our products where applicable.

Significance of the CE mark

The CE mark on a product indicates the manufacturer's certification that the product conforms to the relevant European Directives; this is a prerequisite for placing a product that is subject to the requirements of one or more Directives on the market and allowing its free circulation within European Union countries. The CE mark is intended for use by those responsible for regulating national markets.

Where electrical equipment is concerned, conformity to standards indicates that the product is fit for use. Only a warranty by a well-known manufacturer can provide reassurance of a high level of quality.

As far as our products are concerned, one or more Directives are likely to apply in each case; in particular:

- The Low Voltage Directive (2014/35/EU)
- The Electromagnetic Compatibility Directive (2014/30/EU)
- The ATEX CE Directive (2014/34/EU)
- The Machinery Directive (2006/42/EU)

Hazardous substances

These products are compatible with:

- The WEEE Directive (2012/19/EU)
- The RoHS Directive (2011/65/EU)
- The China RoHS Directive (Standard GB/T 26572-2011)
- REACH regulations (EC No. 1907/2006)

Note: Documentation on sustainable development is available on our website www.se.com (product environmental profiles and instructions for use, RoHS and REACH directives).

End of life (WEEE)

End of life products containing electronic cards must be dealt with by specific treatment processes.

When products containing backup batteries are unusable or at end of life they must be collected and treated separately. Batteries do not contain a percentage by weight of heavy metals above the limit specified by European Directive 2013/56/EU.

Life Is On



Learn more about our products at
www.se.com

The information provided in this documentation contains general descriptions and/or technical characteristics of the performance of the products contained herein. This documentation is not intended as a substitute for and is not to be used for determining suitability or reliability of these products for specific user applications. It is the duty of any such user or integrator to perform the appropriate and complete risk analysis, evaluation and testing of the products with respect to the relevant specific application or use thereof. Neither Schneider Electric nor any of its affiliates or subsidiaries shall be responsible or liable for misuse of the information contained herein.

Design: Schneider Electric
Photos: Schneider Electric

Schneider Electric Industries SAS

Head Office
35, rue Joseph Monier - CS 30323
F-92500 Rueil-Malmaison Cedex
France

DIA6ED2131203EN
February 2021 - V12.0