

Automation & Control Modicon M340 automation platform

Unity

Catalogue
October

06



Simply Smart !

telemecanique.com



This international site allows you to access all the Telemecanique products in just 2 clicks via comprehensive range data-sheets, with direct links to:

- Complete library: technical documents, catalogs, certificates, FAQs, brochures...
- Selection guides from the e-catalog.
- Product discovery sites and their Flash animations.

You will also find illustrated overviews, news to which you can subscribe, a discussion forum, the list of country contacts...

To live automation solutions every day!



Flexibility

- Interchangeable modular functions, to better meet the requirements for extensions
- Software and accessories common to multiple product families



Ingenuity

- Auto-adapts to its environment, "plug & play"
- Application functions, control, communication and diagnostics embedded in the products
- User-friendly operation either directly on the product or remotely



Simplicity

- Cost effective "optimum" offers that make selection easy for most typical applications
- Products that are easy to understand for users, electricians and automation specialists
- User-friendly intuitive programming



Compactness

- High functionality in a minimum of space
- Freedom in implementation



Openness

- Compliance with field bus, connection, and software standards
- Enabling decentralised or remote surveillance via the web with Transparent Ready products

	Modicon M340 hardware and Unity software, a naturally productive pair	<i>page 2</i>
1	– Modicon M340 processors, racks and power supply modules	
	Processors selection guide	<i>page 1/2</i>
	Processors modules	<i>page 1/4</i>
	Power supply modules	<i>page 1/10</i>
	Single rack configuration	<i>page 1/14</i>
2	– Input/output modules	
	2-1 Discrete I/O modules	<i>page 2/6</i>
	2-2 Analog I/O modules and programmable process control	<i>page 2/24</i>
	2-3 IP 67 and IP 20 distributed I/O modules	<i>page 2/34</i>
	2-4 Counter modules and Motion Function Blocks	<i>page 2/36</i>
3	– Communication	
	Selection guide	<i>page 3/2</i>
	3-1 Ethernet TCP/IP network - Transparent Ready	<i>page 3/4</i>
	3-2 CANopen machine and installation bus	<i>page 3/38</i>
	3-3 Modbus and character mode serial link	<i>page 3/42</i>
4	– Unity software	
	Selection guide	<i>page 4/2</i>
	Unity software	<i>page 4/4</i>
5	– Connection interfaces	
	Selection guide	<i>page 5/2</i>
	Advantys Telefast ABE 7 pre-wired system	<i>page 5/8</i>
6	– Services	
	Technical information	
	Standards, certifications and environment conditions	<i>page 6/2</i>
	Automation product certifications	<i>page 6/6</i>
	Power consumption table	<i>page 6/8</i>
	Index	
	Product reference index	<i>page 6/9</i>

Modicon hardware platforms and Unity software

A naturally productive pair

The family of Modicon platforms associated with Unity software offers you ingenuity, flexibility and openness to ever-increasing productivity.

Modicon M340 concentrates power and innovation, offering the optimum response to the needs of machine manufacturers. It is also the ideal companion for **Modicon Premium** and **Modicon Quantum** to satisfy the need for automation of industrial processes and infrastructures.

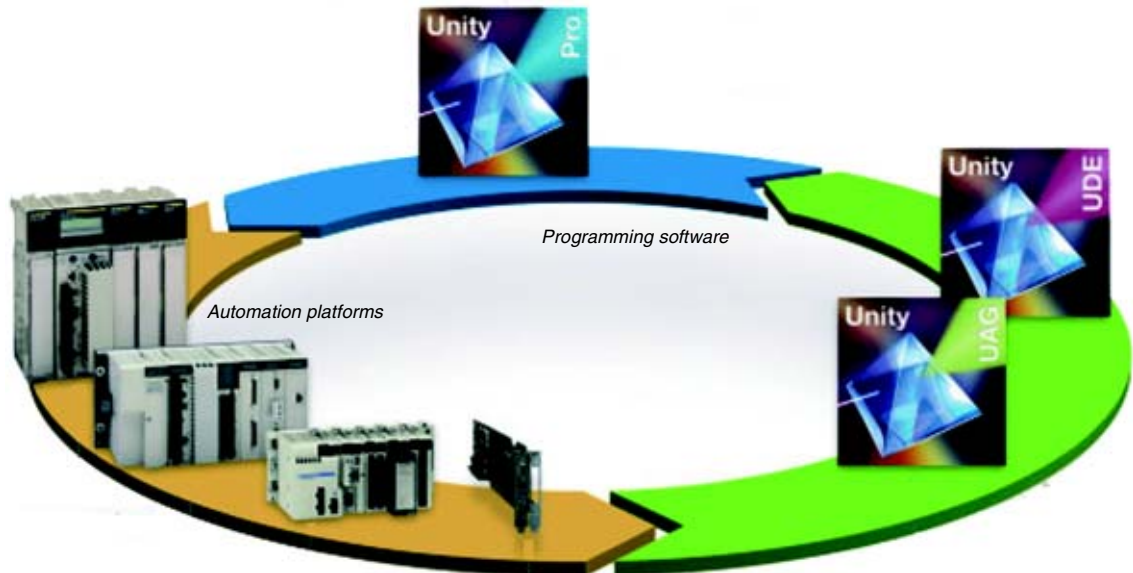

Modicon automation platforms

Modicon M340, the ideal solution for machine specialists

Robust, powerful and compact, the new Modicon M340 PLC is the ideal solution for machine manufacturers in applications such as secondary packaging, materials handling, textiles, printing, food processing, woodworking machines, ceramics, etc. The integration of Altivar and Lexium variable speed drives, Magelis display units and Preventa safety modules has been boosted in order to simplify the setup and use of Telemecanique solutions.

Modicon M340 is also the ideal companion for Modicon Premium and Modicon Quantum to meet the demand for automation of industrial processes and infrastructures, at the heart of Transparent Ready architectures.

Modicon Premium, the optimum solution for the manufacturing industry and infrastructures

Modicon Premium stands out as the specialist in complex machines and manufacturing processes. Its level of performance when processing Boolean, numeric instructions and instructions on tables make it the market reference. Thanks to its ability to integrate distributed architectures, Modicon Premium provides ideal solutions for infrastructure projects, particularly in the water and transport sectors.

In addition, Modicon Atrium, the version of Modicon Premium in PCI format, offers a "PC Based" alternative.

Modicon Quantum, the specialist in critical systems in the process industries and infrastructures

Capable of incredible distributed architectures, with an extensive catalog of modules complemented by several technological partnerships in the context of the Collaborative Automation program, Modicon Quantum offers a perfect response to the needs of continuous or semi-continuous industrial processes, and control of large infrastructure sites.

Capitalizing on more than 25 years' experience in the field of redundancy, Modicon Quantum is the ideal solution for applications requiring very high levels of availability. The offer is therefore suitable in native fashion for critical applications such as petrochemicals, metallurgy, cement, energy, tunnels and airports.

(*) Smarter and more intelligent, yet even easier to use.

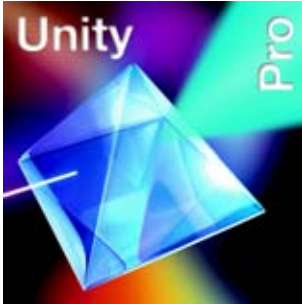

Unity software

An organizer environment for Modicon platforms

Unity Pro is the common programming, debugging and run-time software for Modicon M340, Premium and Quantum PLCs, and Atrium slot PLCs.

As an IEC 61131-3 program, Unity Pro is based on the acknowledged standards of PL7 and Concept. It opens the doors of a complete set of new functions for increased productivity:

- State-of-the-art functionality
- Optimum standardization enabling re-use of developments
- Numerous tools for testing the program and improving system operation
- New integrated diagnostic services

Migration of existing applications is taken into account. This maximizes your software investment, reduces training costs and offers unrivaled potential for development and compatibility.

The Unity software catalog includes specialist software for even better productivity:

- Openness to developments in C language or in VBA (Visual Basic for Applications)
- Design and generation of batch/process applications with PLC/HMI integration



Transparent Ready

Naturally communicative

Based on Ethernet TCP/IP and Web technologies, the Modicon Transparent Ready automation platforms offer solutions to optimizing performances in electrical distribution, automation and control.

Web servers, sending e-mail, direct database access, device synchronization, I/O distribution, etc, Modicon offers you the best of Ethernet.

Collaborative Automation Partner Program



Collaborative Automation

The new world of automation

- Rather than opting for proprietary systems, Telemecanique has adopted market standards such as IEC languages, Ethernet TCP/IP, Modbus IDA, XML, OPC, IT standards, etc.
- Partnerships with recognized leading hardware and software specialists have been developed within the scope of the Collaborative Automation Partner Program, in an effort to share technology more effectively.
- You will be assured of designing the best solution without compromising on ease of integration.

Modicon M340 automation platform

Hardware base



Modicon M340 platform

New Modicon M340 platform

Equipped with astounding memory and performances, this featherweight version will imbue your applications with new momentum. Designed to operate in total synergy with other Telemecanique devices, Modicon M340 represents pure concentrated power.

Performance

- 7 Kinstructions/ms
- 4 MB of program memory
- 256 KB of data

Compact design

- 3 communication ports integrated in the processor
- H x W x D = 100 x 32 x 93 mm.
- High-density discrete I/O modules with 64 channels in a 32 mm wide format.

Communicative, with its integrated ports

- CANopen machine and installation bus
- Ethernet TCP/IP network - Transparent Ready
- Modbus serial link or character mode
- Remote access via STN, GSM, Radio or ADSL

Expert

- Counter modules with ready-to-use functions
- Function block library dedicated to motion control. MFB (*Motion Function Blocks*) to the PLCopen standard
- Advanced library of process control blocks oriented towards control of machinery

Innovative

- USB port as standard
- Embedded Web server
- Recipe file management via FTP protocol
- "Plug and Load" SD memory card
- No batteries

Ruggedness

- Rack architecture enabling hot swapping of modules during operation (*Hot-Swap*)
- Exceeds the standards in terms of shocks, vibrations, temperature, altitude and withstand to electrical interference.

As standard, Modicon M340 has exclusive services normally reserved for PLCs in a higher category.

Modicon M340 automation platform

Unity Pro software

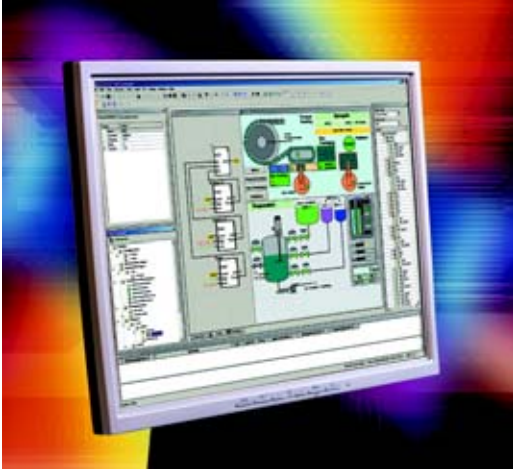

Unity, software productivity

All-in-one, easy-to-use software

Unity Pro fully exploits the advantages of the graphic and contextual interfaces of Windows XP and Windows 2000 :

- Direct access to tools and information
- 100% graphics-based configuration
- Customizable toolbar and icons
- Advanced drag & drop and zoom functions
- Integrated diagnostic window

All the advantages of standardization

Unity Pro provides a complete set of functions and tools for applying the application structure to the structure of the process or machine. The program is divided into hierarchically-organized function modules containing:

- Program sections
- Animation tables
- Operator screens
- Hyperlinks

Basic functions that are used repeatedly can be encapsulated in user function blocks (DFBs) in an IEC 61131-3 language.

Time savings from re-use of modules

Once they have been tested and qualified, your standards reduce development and installation times on site, thereby optimizing quality and reducing lead times:

- Function modules that can be reused in the application or between projects by XML import/export.
- Function blocks instantiated by dragging and dropping them from the library.
- Instances that can be updated automatically to reflect modifications made in the library (if this option is selected by the user)

Maximum quality assured

The integrated PLC simulator faithfully reproduces the behavior of the target program on a PC. All the debugging tools can be used during simulation, to enhance quality before installation:

- Step-by-step program execution
- Breakpoint and watchpoint
- Real-time animations for displaying the state of the variables and the logic during operation

Reduced downtime

Unity Pro features a DFB library for application diagnostics. Integrated into the program, these DFBs can be used (depending on their function) to monitor permanent conditions relating to security and the development of a process over time. A display window provides a clear display of all system and application faults in chronological order (date-stamped at source). From this window, you can simply click to access the editor for the program in which the error occurred (search for missing conditions at source).

Online modifications can be grouped consistently in local mode on a PC and transferred directly to the PLC in a single operation in order to be taken into account in the same scan cycle. A complete range of functions provide the basis for precision control of your operations, to minimize downtime:

- Log of operator actions on Unity Pro in a protected file
- User profile and password protection
- Integrated graphic runtime screens

1 - Processors, power supplies and racks

1 - Modicon M340 processors

Processors selection guide page 1/2

■ Processor modules

- Presentation, description page 1/4
- Memory structure page 1/6
- Characteristics page 1/8
- References page 1/9

■ Power supply modules

- Presentation, description page 1/10
- Functions page 1/11
- Characteristics page 1/12
- References page 1/13

■ Single-rack configuration

- Presentation, description page 1/14
- Functions page 1/14
- References page 1/15
- Dimensions, mounting page 1/15



Modicon M340 automation platform

Modicon M340 processors



Modicon M340 platform for Unity Pro software offer

BMX 34 10 Standard processor



Racks	Number of racks Max. number of slots (excluding power supply module)	1 (4, 6, 8 or 12 slots) 12
Inputs/Outputs	In-rack discrete I/O (1)	512 channels (modules with 8, 16, 32 or 64 channels)
	In-rack analog I/O (1)	128/66 channels (2) (modules with 2, 4, 6 or 8 channels)
	Distributed I/O	Limited depending on the type of medium: Over Ethernet TCP/IP network via network module (63 devices with I/O Scanning function), over Modbus link (32 devices)
In-rack application-specific channels	Max. number of channels (counter and serial link)	20
	Counter (1)	2-channel (60 kHz) or 8-channel (10 kHz) modules
	Motion control	–
	Process control, programmable loops	Process control EFB library
Integrated communication ports	Ethernet TCP/IP network	–
	CANopen Master machine and installation bus	–
	Serial link	1 in RTU/ASCII Modbus master/slave mode or in character mode (non-isolated RS232/RS485, 0.3...19.2 Kbps)
	USB port	1 programming port (PC terminal)
Communication modules	Max. number of networks (1)	1 (BMX NOE 0100 network module)
	Ethernet TCP/IP network	1 x 10BASE-T/100BASE-TX (Modbus TCP/IP, BOOTP/DHCP, FDR, Global Data, I/O Scanning, web server (standard, class B30 or configurable, class C30))
Internal memory capacity	Internal user RAM	2,048 Kb
	Program, constants and symbols	1,664 Kb
	Located/unlocated data	128 Kb
Memory card capacity (on processor)	Backup of program, constants and symbols	8 Mb as standard
	Hosting and display of user web pages	– (3)
	File storage	–
Application structure	Master task	1
	Fast task	1
	Event tasks	32
No. of Kinstructions executed per ms	100% Boolean	4.8 Kinstructions
	65% Boolean + 35% fixed arithmetic	4.4 Kinstructions
Rack power supply		24 V $\overline{\text{---}}$ isolated, 24...48 V $\overline{\text{---}}$ isolated or 100...240 V \sim power supply module

Modicon M340 processor

BMX P34 1000

Page

1/9

(1) The maximum values for the number of discrete I/O, analog I/O and counter channels and the number of networks are not cumulative (they are limited by the number of slots in the single-rack configuration, i.e. 11 maximum).
 (2) The first value is applied to a multi-rack configuration (not available). The second value corresponds to the physical limit with a single-rack configuration.
 (3) User web pages with Ethernet TCP/IP communication module **BMX NOE 0100** and optional memory card **BMX RWS 016MC** (16 Mb available).

BMX 34 20 Performance processors



1 (4, 6, 8 or 12 slots)		
12		
1,024/704 channels (2) (modules with 8, 16, 32 or 64 channels)		
256/66 channels (2) (modules with 2, 4, 6 or 8 channels)		
Limited depending on the type of medium: on CANopen bus (63 devices), on Ethernet TCP/IP network via network module (63 devices with I/O Scanning function), on a Modbus link (32 devices)		
36		
2-channel (60 kHz) or 8-channel (10 kHz) modules		
MFB (Motion Function Blocks) library (control of drives or servo drives on the CANopen bus)	–	MFB (Motion Function Blocks) library (control of drives or servo drives on the CANopen bus)
Process control EFB library		
–	1 x 10BASE-T/100BASE-TX (Modbus TCP/IP, BOOTP/DHCP, FDR, class B10 standard web server)	–
1 (63 slaves, 50...1,000 Kbps, class M20)	–	1 (63 slaves, 50...1,000 Kbps, class M20)
1 in RTU/ASCII Modbus master/slave mode or in character mode (non-isolated RS232/RS485, 0.3...19.2 Kbps)	–	–
1 programming port (PC terminal)		
1 (BMX NOE 0100 network module)		
1 x 10BASE-T/100BASE-TX (Modbus TCP/IP, BOOTP/DHCP, FDR, Global Data, I/O Scanning, web server (standard, class B30 or configurable, class C30))		
4,096 Kb		
3,584 Kb		
256 Kb		
8 Mb as standard		
– (3)		
16 Mb (with optional card BMX RMS 008MPF)		
1		
1		
64		
7.1 Kinstructions		
6.7 Kinstructions		
24 V \equiv isolated, 24...48 V \equiv isolated or 100...240 V \sim power supply module		

BMX P34 2010

BMX P34 2020

BMX P34 2030

Modicon M340 automation platform

Processor modules

Modicon M340 automation platform

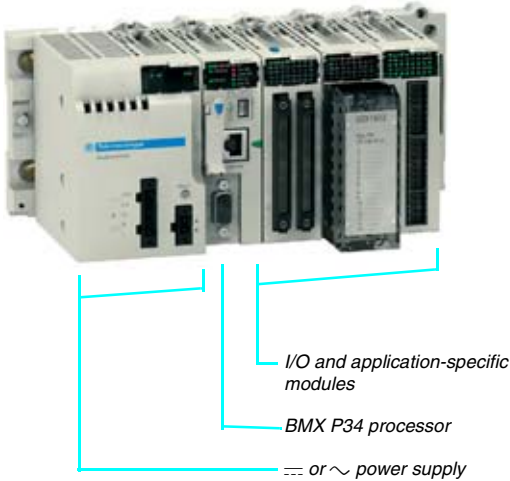

Presentation

Standard and Performance processors from the Modicon M340 automation platform manage an entire PLC single-rack station on which a maximum of 11 slots can be equipped with:

- Discrete I/O modules
- Analog I/O modules
- Application-specific modules (counter, Ethernet TCP/IP communication)

The four processors offered have different memory capacities, processing speeds, number of I/O and number and type of communication ports.

In addition, depending on the model, they offer a maximum (non-cumulative) of:

- 512 to 1024 discrete I/O
- 128 to 256 analog I/O
- 20 to 36 counter channels
- 0 to 2 Ethernet TCP/IP networks (with or without integrated port and network module)

Depending on the model, Modicon M340 processors include:

- A 10BASE-T/100BASE-TX Ethernet TCP/IP port
- A CANopen machine and installation bus
- A Modbus serial link
- A USB type TER port (for a programming terminal)

Each processor is supplied with a memory card used for:

- Backing up the application (program, symbols and constants)
- Activating a standard web server for the Transparent Ready B10 class integrated Ethernet port (depending on the model)

This memory card can be replaced by another type of memory card, to be ordered separately, that supports:

- Backing up the application and activating the standard web server (same as other card)
- A 16 Mb storage area for additional data organized in a file system (directories and sub-directories)

Programming Modicon M340 applications

To set up processors from the Modicon M340 automation platform, you need either:

- Unity Pro Small programming software
- Unity Pro Medium, Large or Extra Large programming software identical to that used to set up Modicon Premium and Modicon Quantum automation platforms
- With possibly, depending on requirements:
 - Unity EFB toolkit software for developing EF and EFB libraries in C language
 - Unity SFC View software for viewing and diagnostics of applications written in Sequential Function Chart language (SFC) or Grafcet

The function block software libraries provide Modicon M340 processors with the processing capability required to meet the needs of specialist applications in the following areas:

- Process control via programmable control loops (EF and EFB libraries)
- Motion control with multiple independent axis functions (MFB (*Motion Function Blocks*) library). The axes are controlled by Altivar 31/71 variable speed drives or Lexium 05/15 servo drives connected over the CANopen machine and installation bus.

Modicon M340 automation platform

Processor modules

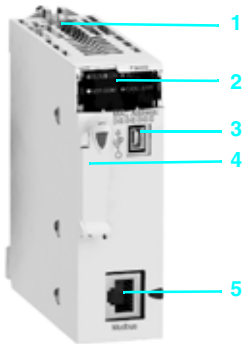

BMX P34 1000

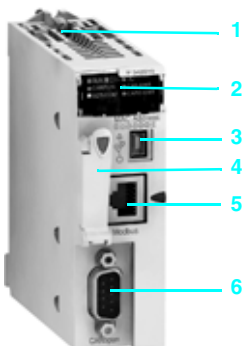

BMX P34 2010

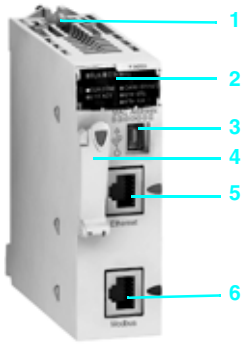

BMX P34 2020

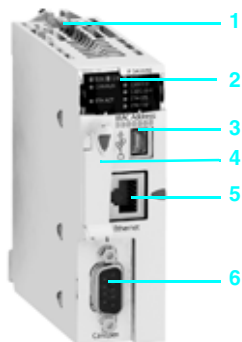

BMX P34 2030

Description of BMX P34 1000/2010 processors

BMX P34 1000/2010 Standard and Performance single-format processors have the following on the front panel:

1 Safety screw for locking the module in its slot (marked 0) in the rack

2 A display block comprising 5 or 7 LEDs, depending on the model:

RUN LED (green): Processor running (program executing)

ERR LED (red): Processor or system fault

I/O LED (red): I/O module fault

SER COM LED (yellow): Activity on the Modbus serial link

CARD ERR LED (red): Memory card missing or faulty

With, in addition, for model **BMX P34 2010**:

CAN RUN LED (green): Integrated machine/installation bus operational

CAN ERR LED (red): Integrated machine/installation bus fault

3 A mini B USB connector for a programming terminal (or Magelis XBT GT operator interface) (1)

4 A slot equipped with Flash memory card for backing up the application (an LED, located above this slot, indicates recognition of or access to the memory card)

5 An RJ45 connector for the Modbus serial link or character mode link (RS 232C/RS 485, 2-wire, non-isolated)

With, in addition, for model **BMX P34 2010**:

6 A 9-way SUB-D connector for the CANopen master machine and installation bus

Description of BMX P34 2020/2030 processors with integrated Ethernet TCP/IP port

BMX P34 2020/2030 Performance single-format processors have the following on the front panel:

1 Safety screw for locking the module in its slot (marked 0) in the rack

2 A display block comprising 8 or 10 LEDs, depending on the model:

RUN LED (green): Processor running (program executing)

ERR LED (red): Processor or system fault

I/O LED (red): I/O module fault

SER COM LED (yellow): Activity on the Modbus serial link

CARD ERR LED (red): Memory card missing or faulty

ETH ACT LED (green): Activity on the Ethernet TCP/IP network

ETH STS LED (green): Ethernet TCP/IP network status

ETH 100 LED (red): Data rate on the Ethernet TCP/IP network (10 or 100 Mbps)

With, in addition, for model **BMX P34 2030**:

CAN RUN LED (green): Integrated machine/installation bus operational

CAN ERR LED (red): Integrated machine/installation bus fault

3 A mini B USB connector for a programming terminal (or Magelis XBT GT operator interface) (1)

4 A slot equipped with Flash memory card for backing up the application (an LED, located above this slot, indicates recognition of or access to the memory card)

5 An RJ45 connector for connection to the Ethernet TCP/IP 10BASE-T/100BASE-TX network

Also included, depending on the model:

6 **BMX P 34 2020** processor: An RJ45 connector for the Modbus serial link or character mode link (RS 232C/RS 485, 2-wire, non-isolated)

7 **BMX P 34 2030** processor: A 9-way SUB-D connector for the CANopen master machine and installation bus

On the back panel there are two rotary switches for assigning the IP address. There are three ways to define this assignment:

Address set by the position of the two switches

Address set by the application parameters

Address set by the Ethernet TCP/IP BOOTP server

(1) The Magelis XBT GT graphic terminal requires Vijeo Designer configuration software version 4.5. Available 1st quarter 2007.

Memory structure

BMX P34 1000/2000 processor with memory card supplied as standard

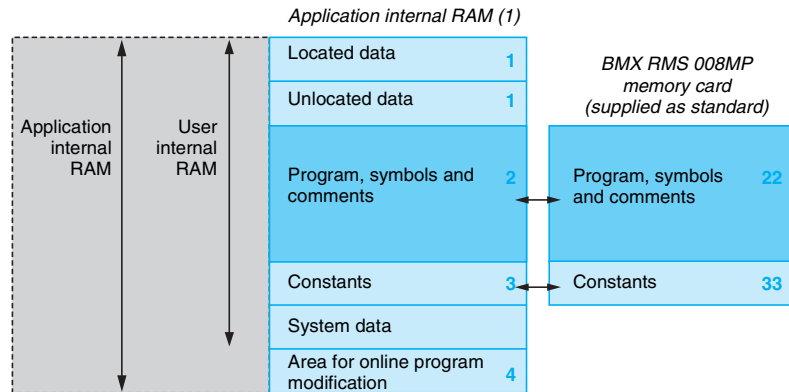

Application internal RAM

The application memory is divided into memory areas, physically distributed in the Modicon M340 processor's internal RAM:

- 1 Application data area, which may be one of two 2 possible types:
 - Located data, corresponding to the data defined by an address (for example %MW237) with which a symbol can be associated (for example, Counter_reject).
 - Unlocated data, corresponding to data defined only by a symbol. The use of unlocated data eliminates the restrictions of managing the memory location since the addresses are assigned automatically and also allows data to be structured and re-used.

This data area is backed up automatically when the PLC is turned off by duplicating its contents in a 256 Kbyte non-volatile internal memory integrated in the processor. It is also possible to back up this memory at any time with a user program.

- 2 Program, symbols and comments area: At program level this area contains the executable binary code and IEC source code.
- 3 Constants area: This area supports the constant located data (%KW_i).
- 4 Area for online program modification (see page 1/7)

The user can choose to transfer the source data to the executable program in the PLC. The fact of having the program source in the PLC means that, when an empty programming terminal is connected to the PLC, all the elements needed to debug or upgrade this application can be restored to the terminal. Comments and animation tables can be excluded from the data embedded in the PLC.

Memory card

Modicon M340 processors are supplied with an SD (*Secure Digital*) type Flash memory card. This memory card is intended for backing up the program, symbols and comments area 2 and the constants area 3.

Duplication (for areas 22 and 33) and retrieval (on return of power) operations are managed automatically by the system and are therefore transparent to the user.

This card (formatted by Schneider Electric and supplied with each processor) is referenced as a replacement part **BMX RMS 008MP**.

(1) For the size of the different memory areas, see characteristics, page 1/8.

Memory structure (continued)

BMX P34 20●0 processor with BMX RMS 008MPF memory card

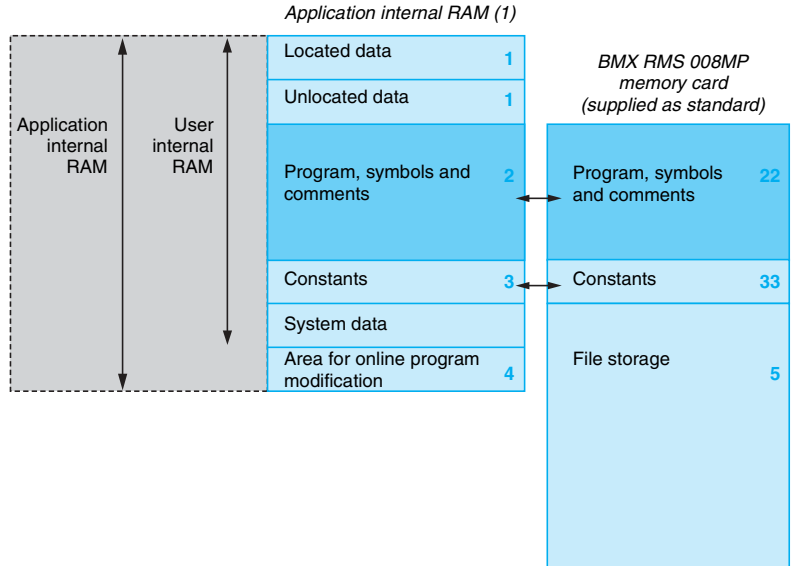

In place of the BMX RMS 008MP memory card (supplied as standard with each processor), **BMX P34 2010/2020/2030** processors can take the **BMX RMS 008MPF** memory card. With the three above-mentioned processors, this card also offers (in addition to the features of the BMX RMS 008MP card supplied as standard described on page 1/6):

- 5 A file storage area (for additional data, such as production data and manufacturing recipes): This area is limited to 16 Mb. These files can be managed from the application program or by any FTP client connected to the Ethernet TCP/IP port integrated in the processor.

For **BMX P34 2020/2030** processors with integrated Ethernet TCP/IP port, the **BMX RMS 008MPF** memory card also offers standard web services (Transparent Ready class B10).

The Unity Pro programming software assists the application designer with managing the structure and memory space occupation of the Modicon M340 automation platform.

Protecting the application

If necessary, it is possible to prohibit access to the application (in terms of reading or modifying the program) by only loading the executable code to the PLC. Additionally, a memory protection bit, set in configuration mode, is also available to prevent any program modification (via the programming terminal or downloads).

Modifying the program in online mode

As with Modicon Premium and Quantum platforms (with Unity Pro software), the online program modification function is available on the Modicon M340 automation platform with the option of adding or modifying the program code and data in different places in the application in a single modification session (thus ensuring modification is homogenous and consistent with the controlled process).

The application internal RAM memory area 4 authorizes these program modification or addition sessions while observing the recommendation to structure the application program in several, reasonably-sized sections.

Modicon M340 automation platform

Processor modules

Modicon M340 Micro-PLCs have been designed to conform with the main national and international standards relating to electronic devices for industrial control systems (see pages 6/2 to 6/7 “Standards, certifications and environmental conditions”).

Characteristics and performance

Processor			Standard	Performance		
			BMX P34 1000	BMX P34 2010	BMX P34 2020	BMX P34 2030
Maximum configuration	No. of racks	4, 6, 8 or 12 slots	1			
	Max. number of slots for processor and modules (excluding power supply module)		12			
Functions	Max. no. (1)	Discrete I/O	512	1,024, 704 in single-rack configuration (64 I/O x 11)		
		Analog I/O	128, 66 in single-rack configuration (4I/2Q x 11)	256, 66 in single-rack configuration (4I/2Q x 11)		
		Control channels	Programmable loops (via CONT-CTL process control EFB library)			
		Counter channels	20	36		
		Motion control	–	Independent axes on CANopen bus (via MFB library)	–	Independent axes on CANopen bus (via MFB library)
	Integrated connections	Ethernet TCP/IP	–	1 RJ45 port, 10/100 Mbps, with Transparent Ready class B10 standard web server		
		CANopen master bus	–	1 (9-way SUB-D)	–	1 (9-way SUB-D)
		Serial link	1 RJ45 port, Modbus master/slave RTU/ASCII or character mode (non-isolated RS 232C/RS 485), 0.3...19.2 Kbps			–
		USB port	1 port, 12 Mbps			
	Communication module	Ethernet TCP/IP	1 RJ45 port, 10/100 Mbps, with Transparent Ready class B30 standard web server or Transparent Ready class C30 configurable web server (2) (with BMX RWS 016MC memory card inserted in BM%X NOE 0100 module)			
Internal user RAM	Total capacity	Kb	2,048	4,096		
	Program, constants and symbols	Kb	1,664	3,584		
	Data	Kb	128	256		
Memory card	Supplied as standard (reference BMX RMS 008MP)		Backup of program, constants, symbol and data		Activation of standard web server, class B10	
	To be ordered separately (reference BMX RMS 008MPF)		Backup of program, constants, symbol and data		File storage, 16 Mb	
			–		Activation of standard web server, class B10	
			–		–	
Maximum size of object areas	Located internal bits	Maximum	bits	16,250 %Mi	32,464 %Mi	
		Default	bits	256 %Mi	512 %Mi	
	Located internal data	Maximum	Bytes	32,464 %MWi internal words, 32,760 %KW constant words		
		Default	Bytes	512 %MWi internal words, 128 %KW constant words, 1,024 %MWi internal words, 256 %KW constant words		
	Max. unlocated internal data	Kb	128 (3)	256 (3)		
Application structure	Master task		1 cyclic or periodic			
	Fast task		1 periodic			
	Auxiliary tasks		–			
	Event tasks		32 (including 2 with priority)	64 (including 2 with priority)		
Execution time for one instruction	Boolean		µs	0.18	0.12	
	On words or fixed point arithmetic	Single-length words	µs	0.38	0.25	
		Double-length words	µs	0.26	0.17	
	On floating points		µs	1.74	1.16	
No. of Kinstructions executed per ms	100% Boolean		Kinst/ms	5.4	8.1	
	65% Boolean and 35% fixed arithmetic		Kinst/ms	4.2	6.4	
System overhead	Master task		ms	1.05	0.70	
	Fast task		ms	0.20	0.13	
Power consumption		With 24 V ~ voltage	mA	72	90	95 135

(1) Only affects in-rack modules. The remote I/O on the CANopen bus are not included in these maximum numbers.

(2) Class C30 with **BMX RWS 016MC** memory card inserted in **BMX NOE 0100** Ethernet TCP/IP network module.

(3) The size of the located data (internal bits and data) and the size of the configuration data should be deducted from this value.

Modicon M340 automation platform

Processor modules

BMX P34 Modicon M340 processors

Modicon M340 processor modules are supplied with the **BMX RMS 008MP** Flash memory card. This card performs the following actions transparently:

- Backing up the application (program, symbols and constants) supported in the processor internal RAM that is not backed up,
- Activation of the Transparent Ready class B10 standard web server (with **BMX P34 2020/2030** Performance processors).

This card can be replaced by another card featuring a file storage option.



BMX P34 1000



BMX P34 2010/2030



BMX P34 2020



BMX RMS 008MP / MPF



BMX XCA USB0

I/O capacity (1)	Memory capacity	Max. no. of network modules	Integrated communication ports	Reference (3)	Weight kg
Standard BMX P340 10					
512 discrete I/O 128 analog I/O 20 application-specific channels	2,048 Kb integrated	1 Ethernet TCP/IP network	Modbus serial link	BMX P34 1000	0.200
Performance BMX P340 20					
1,024 discrete I/O 256 analog I/O 36 application-specific channels	4,096 Kb integrated	1 Ethernet TCP/IP network	Modbus serial link CANopen bus	BMX P34 2010	0.210
			Modbus serial link Ethernet TCP/IP network	BMX P34 2020	0.205
			Ethernet TCP/IP network CANopen bus	BMX P34 2030	0.215

Memory card

Description	Use	Processor compatibility	Reference	Weight kg
Memory card 16 Mb	As replacement for the memory card supplied as standard with each processor, used for: <ul style="list-style-type: none"> - Backup of program, constants, symbol and data - File storage, 16 Mb - Activation of class B10 web server 	BMX P34 20●0	BMX RMS 008MPF	0.002

Separate parts

Description	Use		Length	Reference	Weight kg
	From	To			
Terminal port/USB cordsets	Mini B USB port on the Modicon M340 processor	PC terminal type A USB port	1.8 m	BMX XCA USB018	0.065
			4.5 m	BMX XCA USB045	0.110

Replacement parts

Description	Use	Processor compatibility	Reference	Weight kg
Memory card 8 Mb	Supplied as standard with each processor, used for: <ul style="list-style-type: none"> - Backup of program, constants, symbol and data - Activation of class B10 web server 	BMX P34 1000 / 20●0	BMX RMS 008MP	0.002

(1) For I/O capacity in single-rack configuration, see characteristics, page 1/8.

1

Presentation

BMX CPS ●●●0 power supply modules provide the power supply for each **BMX XBP ●●00** rack and the modules installed on it.

There are two types of power supply module:

- Power supply modules for AC supplies
- Power supply modules for DC supplies

Description

The power supply module is selected according to:

- The electrical line supply: 24 V \equiv , 48 V \equiv or 100...240 V \sim
- The required power (see the power consumption table on page 6/8) (1)

BMX CPS ●●●0 power supply modules have the following on the front panel :

- 1 A display block comprising:
 - OK LED (green), lit if rack voltages are present and correct
 - 24 V LED (green), lit when the sensor voltage is present (for BMX CPS 2000/3500 AC power supply modules only)
- 2 A pencil-point RESET pushbutton for a cold restart of the application
- 3 A 2-way connector that can take a removable terminal block (screw or spring-type) for connecting the alarm relay
- 4 A 5-way connector that can take a removable terminal block (screw or spring-type) for connecting the following:
 - \equiv or \sim line supply
 - Protective earth
 - Dedicated 24 V \equiv power supply for the input sensors (for BMX CPS 2000/3500 AC power supply modules only)

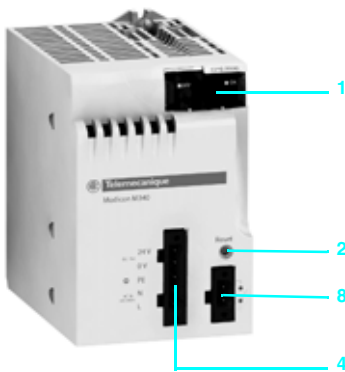

To be ordered separately:

Pack of two removable terminal blocks, depending on the model:

- Screw clamp **BMX XTS CPS10**
- Spring-type **BMX XTS CPS20**

(1) This power consumption calculation for the rack can also be performed by the Unity Pro programming software.

Functions

Alarm relay

The alarm relay located in each power supply module has a volt-free contact accessible from the front of the 2-way connector.

The operating principle is as follows:

In normal operation, with the PLC in RUN, the alarm relay is activated and its contact is closed (state 1).

The relay de-energizes and its associated contact opens (state 0) whenever the application stops, even partially, due to any of the following:

- Occurrence of a blocking fault
- Incorrect rack output voltages
- Loss of supply voltage

RESET pushbutton

The power supply module in each rack has a RESET button on the front panel; when activated, this triggers an initialization sequence for the processor and the rack modules it supplies.

Pressing this pushbutton triggers a sequence of service signals, which is the same as that for:

- A power break when the pushbutton is pressed
- A power-up when the pushbutton is released

In terms of the application, these operations represent a cold start (forcing the I/O modules to state 0 and initializing the processor).

Sensor power supply

The **BMX CPS 2000/3500** AC power supply modules have an integrated 24 V --- voltage supply for powering the input sensors. Connection to this sensor power supply is via the 5-way connector on the front panel.

The power available on this 24 V --- voltage depends on the power supply model (0.45 or 0.9 A) (see characteristics on page 1/12).

Characteristics

☐ power supply module			BMX CPS 2010		BMX CPS 3020		
Primary	Voltage	Nominal	V	24 ☐ isolated		24...48 ☐ isolated	
		Limit (ripple included)	V	18...31.2 ☐		18...62..4 ☐	
	Current	Input nominal I rms	A	1 at 24 V ☐		1.65 at 24 V ☐; 0.83 at 48 V ☐	
		Initial power-up at 25°C (1)		V	24 ☐		24 ☐
		I inrush	A	30		30	60
		I ² t on activation	A ² s	≤ 0.6		≤ 1	≤ 3
		It on activation	As	≤ 0.15		≤ 0.2	≤ 0.3
	Micro-break duration	Line (accepted)	ms	≤ 1			
	Integrated protection			With internal fuse (not accessible)			
	Secondary	Useful power	Max.	W	17		32
3.3 V ☐ voltage (2)		Nominal voltage	V	3.3			
		Nominal current	A	2.5		4.5	
		Typical power	W	8.25		14.85	
24 V ☐ output (3)		Nominal voltage	V	24 ☐			
		Nominal current	A	0.69		1.3	
		Typical power	W	16.8		31.2	
Integrated protection on the voltages (4)			Yes, against overloads, short-circuits and overvoltages				
Max. dissipated power			W	8.5			
Max. length of power supply cable	Copper wires with 1.5 mm ² cross-section		m	20		10	
	Copper wires with 2.5 mm ² cross-section		m	30		15	
Insulation	Dielectric strength	Primary/secondary and primary/ground	V rms	1,500 - 50 Hz for 1 min at an altitude of 0...4,000 m			
	Insulation resistance	Primary/secondary and primary/ground	MΩ	≥ 10			
~ power supply module			BMX CPS 2000		BMX CPS 3500		
Primary	Voltages	Nominal	V	100...240 ~			
		Limit (ripple included)	V	85...264 ~			
	Frequencies	Nominal/limit	Hz	50-60/47-63			
	Power	Apparent	VA	70		120	
	Current	Input nominal I rms	A rms	0.61 at 115 V ~; 0.31 at 240 V ~		1.04 at 115 V ~; 0.52 at 240 V ~	
		Initial power-up at 25°C (1)		V	120 ~	240 ~	120 ~
		I inrush	A	≤ 30		≤ 60	≤ 60
		I ² t on activation	A ² s	≤ 0.5		≤ 2	≤ 1
		It on activation	As	0.03		0.06	≤ 0.05
	Micro-break duration	Line (accepted)	ms	≤ 10			
Integrated protection			With internal fuse (not accessible)				
Secondary	Useful power	Max. overall	W	20		36	
		Max. on 3.3 V ☐ and 24 V ☐ rack output voltages	W	16.5		31.2	
	3.3 V ☐ voltage (2)	Nominal voltage	V	3.3			
		Nominal current	A	2.5		4.5	
		Power (typical)	W	8.25		14.85	
	24 V rack ☐ voltage (3)	Nominal voltage	V	24 ☐			
		Nominal current	A	0.69		1.3	
		Typical power	W	16.8		31.2	
	24 V ☐ sensor voltage (4)	Nominal voltage	V	24 ☐			
		Nominal current	A	0.45		0.9	
Typical power		W	10.8		21.6		
Integrated protection on the voltages (5)			Yes, against overloads, short-circuits and overvoltages				
Maximum dissipated power			W	8.5			
Insulation	Dielectric strength	Primary/secondary (24 V/3.3 V)	V rms	1500			
		Primary/secondary (sensor 24 V)	V rms	2300			
		Primary/ground	V rms	1500			
		24 V sensor output/ground	V rms	500			
	Insulation resistance	Primary/secondary and primary/ground	MΩ	≥ 100			

(1) These values should be taken into account when starting several devices simultaneously and when sizing protection devices.
 (2) 3.3 V ☐ voltage for the I/O module logic power supply
 (3) 24 V ☐ voltage for the I/O module power supply and the processor
 (4) 24 V ☐ sensor output for the sensor power supply
 (5) Protected by a fuse that cannot be accessed

Modicon M340 automation platform

Power supply modules

References

Each **BMX XBP ●●00** rack must be equipped with a power supply module. These modules are inserted in the first two slots of each rack (marked CPS). The power required to supply each rack depends on the type and number of modules installed in the rack. It is therefore necessary to draw up a power consumption table rack by rack in order to determine the **BMX CPS ●●●0** power supply module most suitable for each rack (see page 6/8).



BMX CPS 2010 / 3020



BMX CPS 2000 / 3500

Power supply modules

Line supply	Available power (1)			Total	Reference	Weight kg
	3.3 V --- (2)	24 V rack --- (2)	24 V sensor --- (3)			
24 V --- isolated	8.3 W	16.5 W	–	16.5 W	BMX CPS 2010	0,290
24...48 V --- isolated	15 W	31.2 W	–	31.2 W	BMX CPS 3020	0,340
100...240 V \sim	8.3 W	16.5 W	10.8 W	20 W	BMX CPS 2000	0.300
	15 W	31.2 W	21.6 W	36 W	BMX CPS 3500	0.360

Separate parts

Description	Composition	Type	Reference	Weight kg
Pack of 2 removable connectors	One 5-way terminal block and one 2-way terminal block	Cage clamp	BMX XTS CPS10	0.020
		Spring-type	BMX XTS CPS20	0.015

(1) The sum of the absorbed power on each voltage (3.3 V --- and 24 V ---) should not exceed the total power of the module. See the power consumption table on page 6/8.

(2) 3.3 V --- and 24 V rack --- voltages for powering Modicon M340 PLC modules

(3) 24 V sensor --- voltage for powering the input sensors (voltage available via the 2-way removable connector on the front panel)



Presentation

BMX XBP ●●00 racks are the basic element of the Modicon M340 automation platform in a single-rack configuration.

These racks perform the following functions:

- **Mechanical function:** They are used to install all the modules in a PLC station (power supply, processor, discrete I/O, analog and application-specific I/O). These racks can be mounted on a panel, plate or DIN rail:
 - Inside enclosures
 - On machine frames, etc.
- **Electrical function:** The racks incorporate a Bus X. They are used to:
 - Distribute the power supplies required for each module in the same rack
 - Distribute data and service signals for the entire PLC station
 - Hot swap modules during operation

Description

BMX XBP ●●00 racks are available in 4, 6, 8 or 12-slot versions, and comprise:

- 1** A metal frame that performs the following functions:
 - Holds the Bus X electronic card and protects it against EMI and ESD type interference
 - Holds the modules
 - Gives the rack mechanical rigidity
- 2** A ground terminal for grounding the rack
- 3** Holes for mounting the rack on a frame. These holes are big enough for M6 screws.
- 4** Fixing points for the shielding connection bar
- 5** Tapped holes to take each module locking screw
- 6** A connector for an expansion module. This connector (marked XBE) is not used for this version.
- 7** 40-way female ½ DIN connectors forming the connection between the rack and each module. When the rack is delivered, these connectors are protected by covers that should be removed before inserting the modules.
Slots for anchoring the module pins

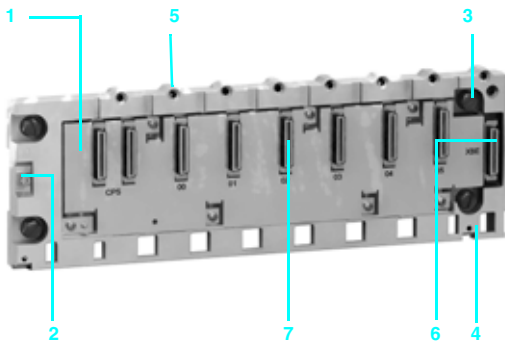

Rack 6 slots BMX XBP 0600

To be ordered separately:

BMX XSP ●●00 cable shielding connection kit, used to protect against electrostatic discharge when connecting the shielding of cordsets for connecting:

- Analog modules
- A Magelis XBT operator interface to the processor (via **BMX XCA USBH0●●** shielded USB cable)

This kit comprises:

- 8** A metal bar that takes the clamping rings
- 9** Two sub-bases to be mounted on the rack
- 10** A set of spring clamping rings for attaching cables with their shielding to the metal bar.
Packs of 10 **STB XSP 30●0** clamping rings can be ordered in addition if required.

Function

Addressing modules in a single-rack configuration

Each rack must contain a power supply module and a processor module.

Inserting different modules in the rack:

- The power supply module always occupies the **CPS** slot.
- The processor module must always be installed in slot **00**.
- Its I/O modules and application-specific modules are installed in slot **01** to slot ...
 - **03** with a 4-slot rack
 - **05** with a 6-slot rack
 - **07** with an 8-slot rack
 - **11** with a 12-slot rack

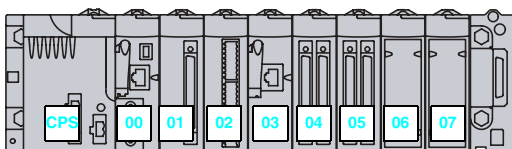

Example of installation with 8-slot rack

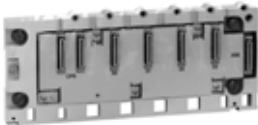

BMX XBP 0400

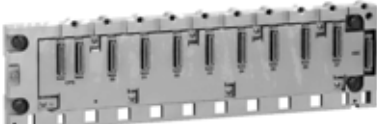

BMX XBP 0800

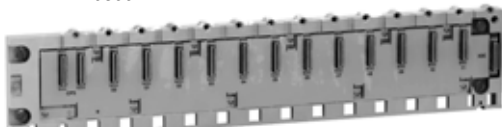

BMX XBP 1200

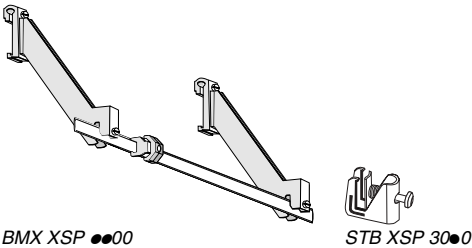

BMX XSP ●●00

STB XSP 30●0

Racks

Description	Type of module to be inserted	No. of slots (1)	Reference	Weight kg
Racks	BMX CPS power supply,	4	BMX XBP 0400	1.470
	BMX P34 processor, I/O modules and	6	BMX XBP 0600	1.750
	application-specific modules (counter, communication)	8	BMX XBP 0800	2.310
		12	BMX XBP 1200	-

Accessories

Description	For use with	Unit reference	Weight kg
Shielding connection kits comprising: - a metal bar - two sub-bases - one set of spring clamping rings	BMX XBP 0400 rack	BMX XSP 0400	0.280
	BMX XBP 0600 rack	BMX XSP 0600	0.310
	BMX XBP 0800 rack	BMX XSP 0800	0.340
	BMX XBP 1200 rack	BMX XSP1200	0.400
Spring clamping rings (pack of 5)	Cables with 1.5...6 mm ² cross-section	STB XSP 3010	0.050
	Cables with 5...11 mm ² cross-section	STB XSP 3020	0.070
Protective covers (pack of 5)	Unoccupied slots on BMX XBP ●●00 rack	BMX XEM 010	0.005

(1) Number of slots taking the processor module, I/O modules and application-specific modules (excluding power supply module).

Dimensions, mounting

BMX XBP

Common side view Front view: BMX XBP example

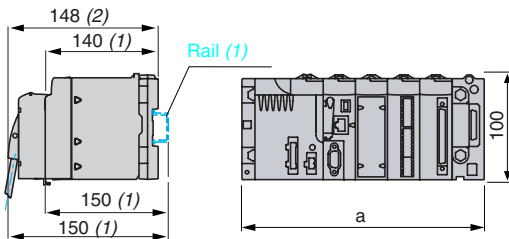

	a
BMX XBP 0400	242.4
BMX XBP 0600	307.6
BMX XBP 0800	372.8
BMX XBP 1200	503.2

(1) With removable terminal block (cage, screw or spring)
(2) With FCN connector

Mounting the racks

On AM1 PA and AM3 PA pre-slotted plate

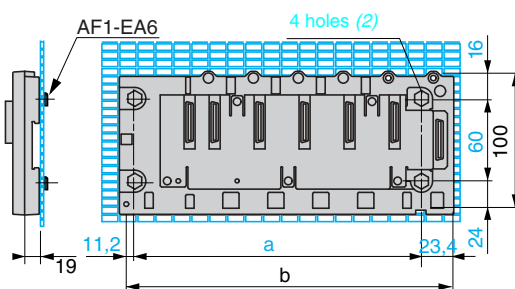

	a	b
BMX XBP 0400	207.8	242.2
BMX XBP 0600	273	307.6
BMX XBP 0800	338.2	372.8
BMX XBP 1200	468.6	503.2

(1) On AM1 ED rail: 35 mm wide, 15 mm deep Only possible with BMX XBP 0400/0600/0800 rack

(2) For panel-mounting: The diameter of the fixing holes must be sufficient to accept M4, M5, M6 and UNC# screws (4.32 to 6.35)

Installation rules

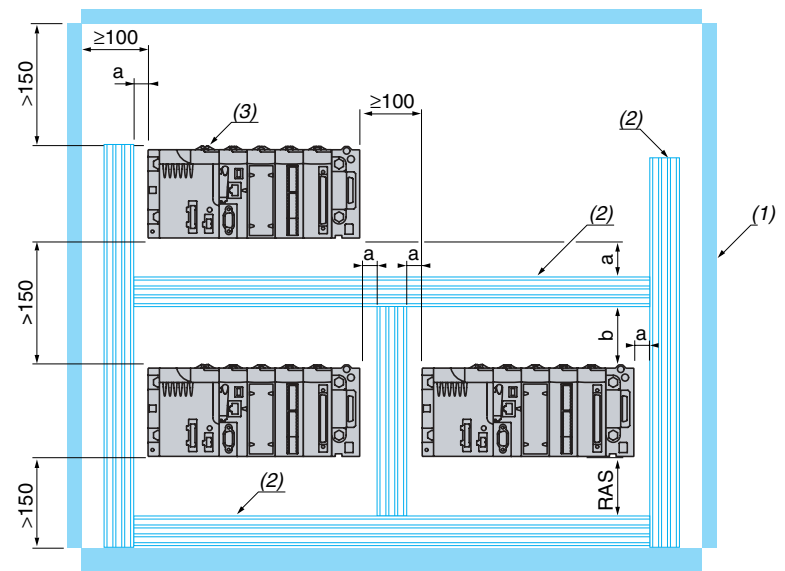

a ≥ 60 mm b ≥ 80 mm

(1) Equipment or enclosure

(2) Cable ducting or clip

2.1 Discrete I/O modules

Discrete input, mixed, and output modules selection guide. page 2/2

- Discrete I/O modules
 - Presentation, description page 2/6
 - Functions page 2/8
 - Characteristics page 2/10
 - References page 2/16
 - Connections page 2/18

2.2 Analog I/O modules and process control

Analog I/O modules selection guide page 2/22

- Analog I/O modules
 - Presentation, description page 2/24
 - Connections page 2/25
 - Functions page 2/26
 - Characteristics page 2/28
 - References page 2/31
- Programmable process control page 2/32

2.3 Distributed I/O

IP 67 and IP 20 distributed I/O selection guide. page 2/34

2.4 Counter modules and Motion Function Blocks

- Counter modules
 - Presentation, description page 2/36
 - Functions page 2/37
 - Characteristics page 2/40
 - References page 2/41
 - Connections page 2/42
- MFB, Motion Function Blocks page 2/44

Modicon M340 automation platform

Discrete I/O modules

Input modules and mixed I/O modules

Applications

16-channel input modules
 Connection via cage clamp, screw clamp or spring-type removable terminals



Type	
Voltage	
Modularity (Number of channels)	
Connection	
Isolated inputs	IEC 1131-2 conformity Logic Sensor compatibility in accordance with standard IEC 947-5-2
Isolated outputs	Fallback IEC 1131-2 conformity Protection Logic
Module	
Page	

<table border="1"> <tr> <td>---</td> <td>24 V</td> <td>48 V</td> </tr> </table>	---	24 V	48 V	<table border="1"> <tr> <td>--- or ~</td> <td>24 V</td> </tr> </table>	--- or ~	24 V	<table border="1"> <tr> <td>~</td> <td>48 V</td> <td>100...120V</td> </tr> </table>	~	48 V	100...120V
---	24 V	48 V								
--- or ~	24 V									
~	48 V	100...120V								
16 isolated channels										
Via BMX FTB 2000/2010/2020 20-way cage clamp, screw clamp or spring-type removable terminals										
Type 3	Type 1	Type 1 (~)	Type 3							
Positive		Pos. or neg.	-							
2-wire ---, 3-wire --- PNP any type		2-wire ---/~, 3-wire --- PNP or NPN any type	2-wire ~							
BMX DDI 1602	BMX DDI 1603 ▲	BMX DAI 1602 ▲	BMX DAI 1603 ▲	BMX DAI 1604						
2/17										

Compatibility with installation help system	Tego Dial TeSys Quickfit
Compatibility with Advantys Telefast ABE 7 pre-wired system	Connection sub-bases Input and output adaptor sub-bases
Passive connection sub-base	Optimum "Economy" Optimum "Miniature" Universal
Relay adaptor sub-base	Fixed relays Plug-in relays
Preformed cordsets with 40-way connector	
Pages	

-
-
-
-
-
-
-
-
-
-

▲ Available 2nd quarter 2007

2
 .1

32/64-channel high-density input modules
Connection via 40-way connectors with preformed cordsets



16/32-channel mixed I/O modules
Connection via cage clamp, screw clamp or spring-type removable terminals



--- 24 V	
32 isolated channels	64 isolated channels
Via one 40-way connector	Via two 40-way connectors
Type 3	Non-IEC
Positive	
2-wire ---, 3-wire --- PNP any type	-

--- 24 V I/O

--- and ~ (outputs only) 24 V inputs, relay outputs
--

--- 24 V I/O

8 isolated inputs and 8 isolated outputs
Via BMX FTB 2000/2010/2020 20-way cage clamp, screw clamp or spring-type removable terminals
Type 3

16 isolated inputs and 16 isolated outputs
Via one 40-way connector

Positive	-	Positive
----------	---	----------

Configurable output fallback, continuous monitoring of output control and resetting of outputs in case of internal fault		
Yes		
Protected	Not protected	Protected
Positive	-	Positive

BMX DDI 3202K

BMX DDI 6402K

BMX DDM 16022

BMX DDM 16025

BMX DDM 3202K

2/17

2/18

APE 1B24M Dialbase interface with 8I/8Q

LU9 G02 splitter boxes (8 motor starters) and BMX FCC ●●1/●●3 preformed cordsets

-

-

APE 1B24M Dialbase interface

LU9 G02 splitter boxes (8 motor starters) and BMX FCC ●●1/●●3 preformed cordsets

Depending on model, 8- or 16-channel passive sub-bases, with or without LED, with common or 2 terminals per channel

Depending on model, 16-channel active sub-bases with solid state or electromechanical, fixed or removable relays, 5...48 V ---, 24 V ---, 24 V...240 V ~ or volt-free, with common or 2 terminals per channel, screw or spring-type connection

ABE 7H20E●00

ABE 7H16C●●

ABE 7H08R●●/7H08S21,
ABE 7H16R1●/7H16R50,
ABE 7H16R2●/7H16S21,
ABE 7H16R3●/7H16R23,
ABE 7H16S43,

ABE 7S16E2●●

ABE 7P16F31●●

BMX FCC ●●1/FCC ●●3

5/10 to 5/15, 2/18

-

-

-

-

-

-

-

ABE 7H20E●00

ABE 7H16C●●

ABE 7H08R●●/7H08S21,
ABE 7H16R1●/7H16R50,
ABE 7H16R2●/7H16S21,
ABE 7H16R3●/7H16R23,
ABE 7H16S43/7H16F43

ABE 7S16E2●●

ABE 7P16F31●●

BMX FCC ●●3

5/10 to 5/15, 2/18

Modicon M340 automation platform

Discrete I/O modules
Output modules

Applications

32/64-channel high-density output modules
Connection via 40-way connectors with preformed cordsets



Type
Voltage
Current
Modularity (Number of channels)
Connection
Isolated outputs
Fallback
IEC 1131-2 conformity
Protection
Logic
Discrete output module

--- solid state
24 V
0.1 A per channel
32 protected channels
64 protected channels
Via one 40-way connector
Via two 40-way connectors
Configurable output fallback, continuous monitoring of output control and resetting of outputs in case of internal fault
Yes
Current limiter with electronic tripping
Positive
-
BMX DDO 3202K
BMX DDO 6402K

Page

2/17

Compatibility with installation help system
Tego Dial
TeSys Quickfit
Compatibility with Advantys Telefast ABE 7 pre-wired system
Connection sub-bases
Input adaptor sub-bases

-
-
-
-

Passive sub-base
Optimum "Economy"
Optimum "Miniature"
Universal

ABE 7H20E●00
ABE 7H16C●●
ABE 7H08R●●/7H08S21, ABE 7H16R1●/7H16R50, ABE 7H16R2●/7H16S21, ABE 7H16R3● ABE 7H16F43

Relay adaptor sub-base
Fixed relays
Removable relays

ABE 7S16S●●● / 7R16S
ABE 7R16T●●●/7P16T●●●

Preformed cordsets with 40-way connector

BMX FCC●●1/FCC ●●3

Pages

5/10 to 5/15, 2/18

16-channel output modules

8/16-channel output modules

Connection via cage clamp, screw clamp or spring-type removable terminals



— solid state
24 V —
0.5 A per channel
16 protected channels

~ triac
100...240 V
0.6 A per channel
16 non-protected channels

—/~ relay	
24 V —, 24...240 V ~	
3 A (lth) per channel	2 A (lth) per channel
8 non-protected channels	16 non-protected channels

Via BMX FTB 2000/2010/2020 20-way cage clamp, screw clamp or spring-type removable terminals

Configurable output fallback, continuous monitoring of output control and resetting of outputs in case of internal fault	
Yes	
Current limiter with electronic tripping	
Positive	Negative
BMX DDO 1602	BMX DDO 1612 ▲

Configurable output fallback		
Yes		
—		
—		
—		
BMX DAO 1605 ▲	BMX DRA 0805	BMX DRA 1605

2/17

—
—
—
—
—
—
—
—
—
—
—
—
—
—
—
—
—
—
—
—
—
—
—
—

▲ Available 2nd quarter 2007

Modicon M340 automation platform

Discrete I/O modules

Presentation

Discrete I/O modules in the Modicon M340 offer are standard modules occupying a single slot, equipped with either of the following:

- A connector for a screw or spring-type 20-way removable terminal block
- One or two 40-way connector(s)

A wide range of discrete inputs and outputs can be used to meet whatever requirements arise in terms of:

- functions, AC or DC I/O, positive or negative logic
- modularity, 8, 16, 32 or 64 channels per module

The inputs receive signals from the sensors and perform the following functions:

- acquisition
- adaptation
- electrical isolation
- filtering
- protection against interference signals

The outputs memorize commands issued by the processor to enable control of the preactuators via the decoupling and amplification circuits.

Description

BMX D●I/D●O/DRA discrete I/O modules are standard format (1 slot). They have a case, which ensures IP 20 protection of the electronics, and are locked into position by a captive screw.

I/O modules connected via 20-way removable terminal block

- 1 Rigid body providing support and protection for the electronic card
- 2 Module reference marking (a label is also visible on the right-hand side of the module)
- 3 Channel status display block
- 4 Connector taking the 20-way removable terminal block for connecting sensors or preactuators

To be ordered separately:

A **BMX FTB 20●0** 20-way removable terminal block or a preformed cordset with a 20-way removable terminal block at one end and flying leads at the other (see page 2/8).

I/O modules connected via 40-way connector

- 1 Rigid body providing support and protection for the electronic card
- 2 Module reference marking (a label is also visible on the right-hand side of the module)
- 3 Channel status display block
- 4 One or two 40-way connectors (32 or 64 channels) (1) for connecting sensors or preactuators
- 5 With the 64-channel module, a pushbutton, which, with successive presses, displays the state of channels 0...31 or 32...63 on the block 3 (see page 2/10)

To be ordered separately, depending on the type of module:

One or two preformed cordset(s) with a 40-way connector (see page 2/8).

(1) Fujitsu FCN 40-way connector

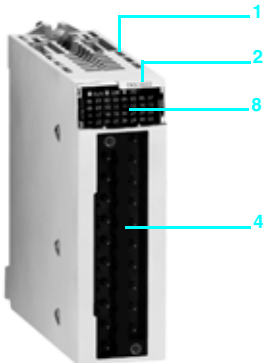

Module and 20-way removable terminal block

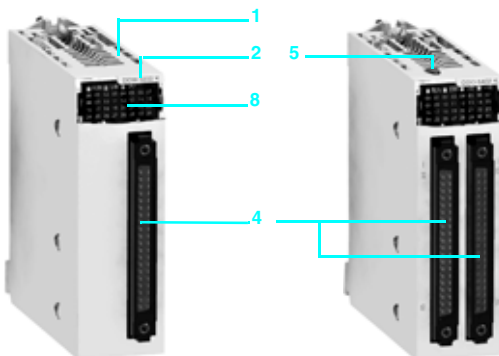

32- and 64-channel modules with for connection via 40-way connector(s)

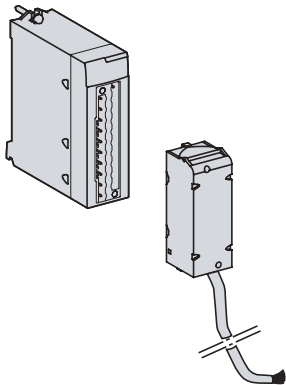

Preformed cordset with removable terminal block at one end and flying leads at the other

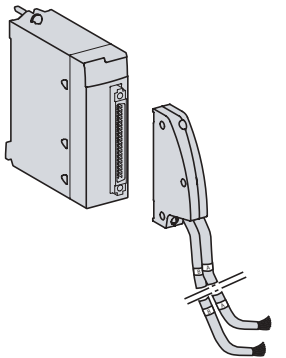

Preformed cordset with 40-way connector at one end and 2 flying leads at the others

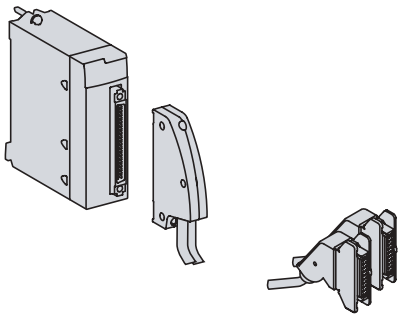

Preformed cordset with 40-way connector and HE 10 connector for Advantys Telefast ABE 7 system

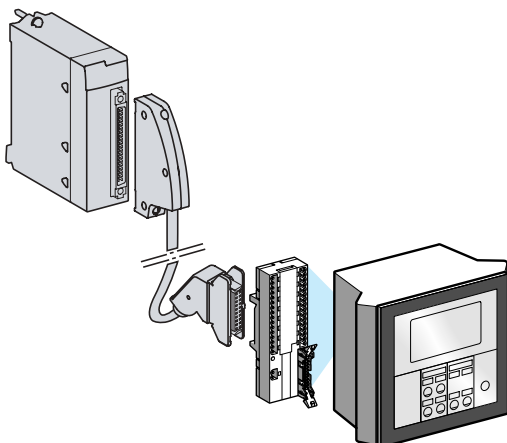

Example of connection to the Tego Dial installation help system

Characteristics:
pages 2/11 to 2/16

References:
pages 2/17 to 2/18

Connections:
pages 2/19 to 2/22

Connecting modules with removable terminal blocks

There are three types of 20-way removable terminal block:

- Screw clamp terminal block
- Cage clamp terminal block
- Spring-type terminal block

Each removable terminal block can take:

- Bare wires
- Wires equipped with DZ5-CE cable ends

One version of the removable terminal block is equipped with **BMX FTW●●1** cordsets with color-coded flying leads (3, 5 or 10 m long).

Cage clamp terminal blocks

The capacity of each terminal is:

- Minimum: One 0.34 mm² wire (AWG 22)
- Maximum: One 1.5 mm² wire (AWG 14)

BMX FTB 2000 cage clamp connectors are equipped with captive screws (maximum tightening torque 0.5 N.m).

Screw clamp terminal blocks

The capacity of each terminal is:

- Minimum: One or two 0.34 mm² wires (AWG 22)
- Maximum: Two 1.5 mm² wires (AWG 14)

BMX FTB 2010 screw clamp connectors are equipped with captive screws (maximum tightening torque 0.5 N.m).

Spring-type terminal blocks

The capacity of each terminal in the **BMX FTB 2020** spring-type terminal blocks is:

- Minimum: Two 0.34 mm² wires (AWG 22)
- Maximum: Two 1.5 mm² wires (AWG 14)

Connecting modules with 40-way connectors

Preformed cordsets with 40-way connector at one end and flying leads at the other

Preformed cordsets can be used for easy direct wire-to-wire connection between the I/O of modules with connectors **1** and the sensors, preactuators or intermediate terminals.

These preformed cordsets comprise:

- At one end, a 40-way connector **2** with either of the following:
 - One sheath **3** containing 20 wires with a cross-section of 0.34 mm² (AWG 22) (**BMX FCW ●●1**)
 - Two sheaths **4**, each containing 20 wires with a cross-section of 0.34 mm² (AWG 22) (**BMX FCW ●●3**)

- At the other end **5**, color-coded flying leads conforming to standard DIN 47100 (see page 2/22)

Preformed cordsets with 40-way connector and HE 10 connector(s)

Two types of cordset can be used for connecting the I/O of modules with 40-way connectors **1** to rapid wiring connection and adaptation interfaces called Advantys Telefast ABE 7 **2** (see page 5/8).

These preformed cordsets comprise:

- At one end, a 40-way connector **3** with either of the following:
 - One sheath **4** containing 20 wires (**BMX FCC ●●1**)
 - Two sheaths **5** each containing 20 wires (**BMX FCC ●●3**)
- At the other end, one or two HE 10 connectors **6**

Connection to Tego Dial and TeSys Quickfit systems

BMX DDI 3202K/6402K input modules and **BMX DDO 3202K/6402K** output modules **1** are designed, amongst other things, for use in conjunction with Tego Dial and TeSys Quickfit installation help systems.

The modules are easily connected using a connection cable.

Modicon M340

automation platform

Discrete I/O modules

Functions

Hot swapping

Due to their integrated devices, I/O modules (including application-specific modules) can be removed and connected while powered up.

Note: When the PLC is powered up and running, the I/O modules can be removed without any material risk by performing the following sequence **before** removing the module:

- Disconnect the power voltage on the outputs
- Disconnect the sensor and preactuator power supply
- Remove the terminal block or connector

I/O module assignment

Discrete I/O modules have different parameters for each channel. The channels are grouped into blocks of 4, 8 or 16 consecutive channels depending on the type of module. Each group of channels can be assigned to a specific application task (master or fast).

Protection of DC inputs

The 24 and 48 V --- inputs are constant-current type. This characteristic makes it possible to:

- Ensure minimum current in active state in compliance with the IEC standard
- Limit the current consumption when the input voltage increases, to avoid unwanted temperature rise in the module
- Reduce the current consumption on the sensor power supply provided by the PLC power supply or by a process power supply

Protection of DC outputs

All protected solid state outputs have a protective device which, when an output is active, can detect the occurrence of:

- An overload or short-circuit: This type of fault deactivates the output (tripping) and indicates a fault on the display on the module front panel (the faulty channel LED flashes, the I/O module fault LED lights up).
- Reverse polarity: This type of fault short-circuits the power supply without damaging the module. For this protection to work in optimum conditions, it is essential to place a fast-blow fuse on the power supply upstream of the preactuators.
- Inductive overvoltage: Each output is protected individually against inductive overvoltages and has a fast zener diode demagnetization circuit for electromagnets, which can reduce the output response time for some fast machines.

Reactivation of DC outputs

If a fault has caused an output to trip, the output can be reactivated using this parameter if no other terminal fault is present.

Reactivation is defined for each group of 8 channels. It has no effect on an inactive channel or one that is not faulty.

The reactivation command can be:

- Programmed: Reactivation is carried out by a command from the PLC application or via the debug screen. To avoid repeated reactivations too close together, the module automatically allows a time delay of 10 s between two reactivations.
- Automatic: Reactivation takes place automatically every 10 s until the fault disappears.

RUN/STOP command

An input can be configured to control the RUN/STOP mode for the PLC.

This is taken into account on a rising edge. A STOP command from an input has priority over a RUN command from a programming terminal or via the network.

Functions (continued)

Output fallback

This parameter defines the fallback mode used by the DC solid state outputs when the PLC stops following a:

- Processor fault
- Rack fault
- Fault on the cable connecting the racks

The outputs must be set to a state that is not harmful to the application. This state, known as the fallback position, is defined for each module when the DC solid state outputs are configured. This configuration offers a choice between:

- Fallback: The channels are set to 0 or 1 according to the fallback value defined for the group of 8 corresponding channels.
- Maintain: The outputs maintain the state in which they were before the stop occurred.

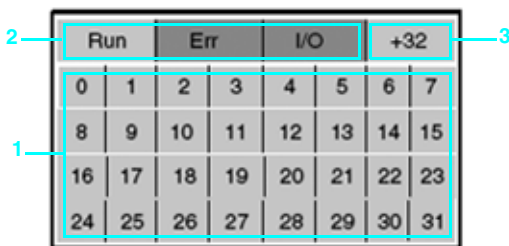

I/O module diagnostics

Each discrete I/O module is equipped with a display block on the front panel centralizing all the information necessary for module control, diagnostics and maintenance. The display block comprises:

- 1 A set of 8, 16 or 32 green LEDs depending on the module modularity. Each LED is associated with one channel:
 - On: channel in state 1; Off: channel in state 0
 - Flashing: channel faulty, overloaded or short-circuited
- 2 Three LEDs indicating the module status:
 - RUN (green): On: Normal operation
 - ERR (red): On: Internal module fault; Flashing: Exchange fault between the module and the processor
 - I/O (red): On: External fault (sensor/preactuator voltage, overload, short-circuit, etc.); Flashing: Terminal block fault
- 3 A +32 LED (green) indicating, in the case of 64-channel modules, whether the set of 32 LEDs 1 displays the state of channels 0...31 (off) or the state of channels 32...63 (on). This +32 LED is activated or deactivated by a pushbutton located on top of the module.

Diagnostics via Unity Pro

Using the integrated diagnostics in Unity Pro, this local diagnostics on the module front panel is complemented by system diagnostics based on predefined screens at global hardware configuration level, module level and channel level (see pages 4/21 and 4/22).

Remote diagnostics using a web browser on a "Thin Client" PC

In addition, the diagnostics described above can be performed remotely using a simple web browser thanks to the standard web server integrated in the Modicon M340 platform (processor with integrated Ethernet port or Ethernet module), using the "ready-to-use" Rack Viewer function (see page 3/4).

Compatibility with 2-wire and 3-wire sensors

Input type	24 V \equiv positive log. (sink)	24 V \equiv type 3 positive log. (sink)	24 V \equiv type 3 positive log. (sink)	24 V \sim type 1	48 V \sim type 3	100...120 V \sim type 3
Any 3-wire \equiv sensor, PNP type						
Any 3-wire \equiv sensor, NPN type						
Telemecanique 2-wire \equiv sensor or other brand, with the following characteristics: - Residual voltage in closed state ≤ 7 V - Minimum switched current ≤ 2.5 mA - Residual current in open state ≤ 1.5 mA						
Telemecanique 2-wire \equiv sensor or other brand with the following characteristics: - Residual voltage in closed state ≤ 4 V - Minimum switched current ≤ 1 mA - Residual current in open state ≤ 0.5 mA						
2-wire \equiv/\sim sensor (1)						
2-wire \sim sensor						

Not compatible
 Compatible

(1) 24 V \sim sensors can be used as positive logic (sink) or negative logic (source) inputs, but are not IEC-compliant.

Common characteristics

Environment

Conformity to standards	NFC 63 850, IEC 664, IEC 1131 2, UL 508, UL7 46C, CSA 22 2 no. 142
Temperature derating	The characteristics at 60°C are assured for 60% of inputs and 60% of outputs at state 1

Characteristics of DC input modules

Module			BMX DDI 1602	BMX DDI 1603	BMX DDI 3202K	BMX DDI 6402K	BMX DAI 1602		
Number of inputs			16		32	64	16		
Connection			Spring or screw-type 20-way removable terminal block		One 40-way connector	Two 40-way connectors	Spring or screw-type 20-way removable terminal block		
Nominal input values	Voltage	V	24 ---	48 ---	24 ---				
	Current	mA	3.5	2.5	2.5	1	3		
	Logic		Positive (<i>sink</i>)				Negative (<i>source</i>)		
Input limit values	At state 1	Voltage	V	≥ 11	≥ 34	≥ 11	≥ 15	≥ 14	
		Current	mA	> 2 (for U ≥ 11 V)	> 2 (for U ≥ 34 V)	> 2 (for U ≥ 11 V)	> 1 (for U ≥ 15 V)	> 2	
	At state 0	Voltage	V	< 5	< 10	< 5			
		Current	mA	≤ 1.5	≤ 0.5	≤ 1.5	≤ 0.5		
Sensor power supply (ripple included)		V	19...30 (possible up to 34 V, limited to 1 hour in every 24 hours)	38...60	19...30 (possible up to 34 V, limited to 1 hour in every 24 hours)				
Input impedance at nominal voltage			KΩ	6.8	19.2	9.6	24	6.4	
Response time (filtering)	Typical	ms	4					10	
	Maximum	ms	7					20	
Reverse polarity			Protected			No	–		
IEC 1131-2 conformity			Type 3	Type 1	Type 3	Non-IEC			
Compatibility with 2-wire/3-wire sensors			IEC 947-5-2			–			
Paralleling of inputs (1)			Yes		No				
Insulation resistance			MΩ	>10 at 500 V ---					
Dielectric strength	Primary/Secondary	Vrms	1,500 - 50/60 Hz for 1 minute (up to 4,000 m)						
	Between groups of channels	V	–		500 ---		–		
Type of input			Current sink				Resistive		
Sensor voltage control threshold	OK	V	> 18 ---	> 36 ---	> 18 ---				
	Fault	V	< 14 ---	< 24 ---	< 14 ---				
Reliability	MTBF in hours	At T _{ambient} = 30°C	798,237		696,320	362,681	1,504,958		
Consumption			Typical					mA	See power consumption table page 6/8
Maximum dissipated power			W	2.5	3.6	3.9	4.3	3	
Temperature derating			None						

(1) This characteristic allows several inputs to be wired in parallel on the same module or on different modules for input redundancy.

Characteristics of AC input modules

Module			BMX DAI 1602	BMX DAI 1603	BMX DAI 1604	
Number of inputs			16			
Connection			Spring or screw-type 20-way removable terminal block			
Nominal input values	Voltage	V	24 ~	48 ~	100...120 ~	
	Current	mA	3	5		
	Frequency	Hz	50/60			
Input limit values	At state 1	Voltage	V	≥ 15	≥ 34	≥ 74
		Current	mA	≥ 2		≥ 2.5
	At state 0	Voltage	V	≤ 5	≤ 10	≤ 20
		Current	mA	≤ 1		
	Frequency		Hz	47...63		
	Sensor power supply (ripple included)		V	20...26	40...52	85...132
Current peak on activation	At nominal voltage	mA	5	95	240	
Input impedance at nominal voltage and F = 55 Hz			KΩ	6	9	13
Response time (filtering)	Activation		ms	15	10	
	Deactivation		ms	20		
IEC 1131-2 conformity			Type 1	Type 3		
Compatibility with 2-wire/3-wire sensors			IEC 947-5-2			
Insulation resistance			MΩ	>10 at 500 V $\overline{\text{---}}$		
Dielectric strength			Vrms	1,500 - 50/60 Hz for 1 minute (up to 4,000 m)		
Type of input			Resistive			Capacitive
Sensor voltage control threshold	OK	V	> 18	> 36	> 82	
	Fault	V	< 14	< 24	< 40	
Reliability	MTBF in hours	At T _{ambient} = 30°C	1,504,958			
Consumption			Typical	mA		See power consumption table page 6/8
Maximum dissipated power			W	3	4	3.8
Temperature derating			None			

Characteristics of triac output module

Module			BMX DAO 1605		
Number of inputs			W	16	
Connection			Spring or screw-type 20-way removable terminal block		
Operating voltages	Nominal		V	100...240 ~	
	Limit		V	85...288 ~	
Currents	Maximum		A	0.6 per channel, 2.4 per common, 4.8 for all 4 commons	
	Minimum			25 mA at 100 V ~, 25 mA at 240 V ~	
Maximum inrush current			A	≤ 20/cycle	
Leakage current	At state 0		mA	≤ 1.5 for 120 V ~, 60 Hz, ≤ 3 for 240 V ~, 60 Hz	
Residual voltage	At state 1		V	≤ 1.5	
Response time	Activation		ms	≤ 1 +/- 0.5 Hz	
Nominal resistive load	Deactivation		ms	≤ 1 +/- 0.5 Hz	
Type of command			Passage through zero		
Built-in protection			Varistor		
Protection fuses			None (use an external fast-blow fuse)		
Dielectric strength			Vrms	2,830 ~/3 cycles (2,000 m altitude)	
Insulation resistance			MΩ	≤ 10	
Reliability			-		
Consumption			Typical	mA	See power consumption table page 6/8
Maximum dissipated power			-		

Characteristics of DC solid state output modules

Module			BMX DDO 1602	BMX DDO 1612	BMX DDO 3202K	BMX DDO 6402K
Number of inputs			16		32	64
Connection			Spring or screw-type 20-way removable terminal block		One 40-way connector	Two 40-way connectors
Output nominal values	Voltage	V	24 ---			
	Current	A	0.5		0.1	
	Logic		Positive (source)	Negative (sink)	Positive (source)	
Output limit values	Voltage (ripple included)	V	19...30 (possible up to 34 V, limited to 1 hour in every 24 hours)			
	Current per channel	A	0.625		0.125	
	Current per module	A	10		3.2	6.4 if $\theta \leq 40^\circ\text{C}$ 5.1 if $\theta \leq 50^\circ\text{C}$ 3.8 if $\theta \leq 60^\circ\text{C}$
Tungsten filament lamp power			W		6 maximum	
Leakage current			At state 0		mA < 0.5	
Residual voltage			At state 1		V < 1.2	
Minimum load impedance			Ω		48	
Response time (1)			ms		1.2	
Maximum overload time			ms		-	
Compatibility with IEC 1131-2 DC inputs			Yes (type 3, not IEC)		Yes (not IEC)	Yes (type 3, not IEC)
Paralleling of outputs			Yes (2 max.)		Yes (3 max.)	
Switching frequency on inductive load			Hz		0.5/LI ²	
Built-in protection			Against overvoltages		Yes, by Transil diode	
			Against inversions		Yes, by reverse-mounted diode. Use a 2 A fuse on the + 24 V of the preactuators.	
			Against short-circuit and overloads		Yes, with current limiter and electronic circuit-breaker 1.5 In < Id < 2 In	
Preactuator voltage control threshold			At state 0		V > 18	
			Fault		V < 14	
Insulation resistance			M Ω		> 10 at 500 V ---	
Dielectric strength			Output/ground or output/internal logic		Vrms 1,500 ~ - 50/60 Hz for 1 minute	
			Between groups of channels		V -	
Reliability MTBF in hours			At T _{ambient} = 30°C		409,413	
Consumption			Typical		mA	
Maximum dissipated power			W		4	
Temperature derating			None		2.26	
					3.6	
					6.85	
					See "Current per module" above	

(1) All outputs are equipped with a fast demagnetization circuit for the electromagnets. Discharge time for the electromagnets < L/R.
 (2) Excluding load current.

Characteristics of relay output modules

Module				BMX DRA 0805				BMX DRA 1605			
Number of inputs				8				16			
Connection				Spring or screw-type 20-way removable terminal block							
Limit operating voltages		DC	V	10...34 ---				24...125 --- (resistive load)			
		AC	V	10...264 ~				200...264 ~ (Cos φ = 1)			
Thermal current				A				3			
Switching load		Minimum	mA	1 at 5 V ---							
Electrical life				-				24 V	200 V	240 V	
AC load		Power cos φ = 0.7	VA	-				-	300 (1), 80 (2)	240 (1), 72 (2)	
		Power cos φ = 0.35	VA	-				-	200 (1), 60 (2)	120 (1), 36 (2)	
DC load		Power	W	-				24 (1), 7.2 (2)	-	-	
Voltage				24 V	48 V	110... 120 V	200... 240 V	24 V	200 V	240 V	
AC load		Resistive loads AC-12	Power	VA	50 (3)	50 (4), 110 (5)	110 (4), 220 (5)	220 (4)	-		
		Inductive loads AC-15 (cos φ = 0.3)	Power	VA	24 (5)	10 (6), 24 (7)	10 (8), 50 (9), 110 (10)	10 (8), 50 (11), 220 (12)	-	200 (1), 60 (2)	120 (1), 36 (2)
		Inductive loads AC-14 (cos φ = 0.7)	Power	VA	-				-	300 (1), 80 (2)	240 (1), 72 (2)
DC load		Resistive loads DC-12	Power	W	24 (4), 40 (13)	-					
		Inductive loads DC-13 (14)	Power	W	10 (7), 24 (4)	-				24 (1), 7.2 (2)	-
Response time		Activation	ms	< 10							
		Deactivation	ms	< 8				< 12			
Built-in protection		Against overloads and short-circuits	None. Use a fast-blow fuse per channel or group of channels								
		Against AC inductive overvoltages	None. Use an RC circuit or ZNO surge limiter appropriate to the voltage in parallel on each output								
		Against DC inductive overvoltages	None. Use a discharge diode on each output								
Insulation resistance				MΩ	> 10 at 500 V ---						
Dielectric strength				Vrms	2,000 - 50/60 Hz for 1 minute						
Reliability		MTBF in hours	At T _{ambient} = 30°C	1,573,341				2,463,296			
Consumption		Typical	mA	See power consumption table page 6/8							
Dissipated power				W	2.7 max.				3		
Temperature derating				None							

- (1) For 1 x 10⁵ operating cycles
 (2) For 3 x 10⁵ operating cycles
 (3) For 0.7 x 10⁶ operating cycles
 (4) For 1 x 10⁶ operating cycles
 (5) For 0.5 x 10⁶ operating cycles
 (6) For 5 x 10⁶ operating cycles
 (7) For 2 x 10⁶ operating cycles
 (8) For 10 x 10⁶ operating cycles
 (9) For 1.5 x 10⁶ operating cycles
 (10) For 0.15 x 10⁶ operating cycles
 (11) For 3 x 10⁶ operating cycles
 (12) For 0.1 x 10⁶ operating cycles
 (13) For 0.3 x 10⁶ operating cycles
 (14) Where L/R = 60 ms for BMX DRA 0805 module, L/R = 7 ms for BMX DRA 1605 module

Characteristics of mixed I/O relay module

Module				BMX DDM 16025			
				24 V $\overline{\text{DC}}$ inputs	24 V $\overline{\text{DC}}$ or 24...240 V \sim relay outputs		
Number of inputs/outputs				8	8		
Connection				Spring or screw-type 20-way removable terminal block			
Nominal values	Inputs	Voltage	V	24 $\overline{\text{DC}}$ (positive logic)			
		Current	mA	3.5			
	Outputs	DC voltage	V	–			
		Direct current	A	2 (resistive load)			
		AC voltage	V	220 \sim , Cos φ = 1			
		Alternating current	A	2			
Input limit values	At state 1	Voltage	V	≥ 11			
		Current	mA	≥ 2 (for $U \geq 11$)			
	At state 0	Voltage	V	5			
		Current	mA	≤ 1.5			
	Sensor power supply (ripple included)		V	19...30 (possible up to 30 V, limited to 1 hour in every 24 hours)			
Relay output voltage					24 V	200 V	240 V
AC load	Inductive loads AC-14 (cos φ = 0.7)	Power	VA	–	–	300 (1), 80 (2)	240 (1), 72 (2)
		Power	VA	–	–	200 (1), 60 (2)	120 (1), 36 (2)
DC load	Inductive loads DC-13	Power	W	–	24 (1), 7.2 (2)	–	–
Maximum switching frequency				–	3,600 cycles/hour		
Input impedance at nominal voltage				KΩ	6.8		
Input response time				Typical	ms	4	
				Maximum	ms	7	
Reverse polarity on inputs				Protected			
IEC 1131-2 conformity				Yes, type 3			
Compatibility with 2-wire/3-wire sensors				IEC 947-5-2			
Paralleling of inputs				No			
Input type				Current sink			
Output response time				Activation	ms	–	
				Deactivation	ms	–	
Switching load				Minimum	V	5 V $\overline{\text{DC}}$ /1 mA	
				Maximum	V	–	
Mechanical durability				No. of switching operations	–	≥ 20 million	
Fuse protection				–	No (use one fast-blow fuse per channel or group of channels)		
Sensor voltage control thresholds				OK	V	> 18	
				Fault	V	< 14	
Insulation resistance				MΩ	> 10 at 500 V $\overline{\text{DC}}$		
Dielectric strength				Primary/secondary	Vrms	1,500 - 50/60 Hz for 1 minute	
				Between groups of I/O	V	500 $\overline{\text{DC}}$	
				Max. voltage	Vrms	–	
Reliability	MTBF in hours	At $T_{\text{ambient}} = 30^{\circ}\text{C}$		912,167			
Consumption				Typical	mA	See power consumption table page 6/8	
Dissipated power				W	3.1 maximum		
Temperature derating					None		

(1) For 1×10^5 operating cycles
 (2) For 3×10^5 operating cycles
 (3) Excluding load current

Characteristics of 24 V $\overline{\text{---}}$ mixed I/O modules

Module			BMX DDM 16022		BMX DDM 3202K			
			Inputs	Solid state outputs	Inputs	Solid state outputs		
Number of inputs/outputs			8	8	16	16		
Connection			Spring or screw-type 20-way removable terminal block		One 40-way connector			
Nominal values			Voltage	24 $\overline{\text{---}}$				
			Current	3.5	500	2.5	100	
			Logic	Positive (<i>sink</i>)	Positive (<i>source</i>)	Positive (<i>sink</i>)	Positive (<i>source</i>)	
Tungsten filament lamp power			W	–	6 maximum	–	1.2 maximum	
Input limit values	At state 1	Voltage	V	≥ 11	–	≥ 11	–	
		Current	mA	> 3 (for $U \geq 11$ V)	–	≥ 2 (for $U \geq 11$)	–	
	At state 0	Voltage	V	5	–	5	–	
		Current	mA	≤ 1.5	–	≤ 1.5	–	
	Sensor power supply (ripple included)	Possible up to 30 V, limited to 1 hour in every 24 hours	V	19...30	–	19...30	–	
Output limit values	Voltage (ripple included)	Possible up to 30 V, limited to 1 hour in every 24 hours	V	–	19...30	–	19...30	
		Currents	Per channel	mA	–	625	–	125
		Per module	A	–	5	–	3.2	
Input impedance at nominal voltage			K Ω	6.8	–	9.6	–	
Input response time			Typical	ms	4	–	4	–
			Maximum	ms	7	–	7	–
Reverse polarity on inputs				Protected	–	Protected	–	
IEC 1131-2 conformity				Yes, type 3	–	Yes, type 3	–	
Compatibility with 2-wire/3-wire sensors				IEC 947-5-2	–	IEC 947-5-2	–	
Input type				Current sink	–	Current sink	–	
Leakage current			At state 0	mA	–	< 0.5	–	0.1
Residual voltage			At state 1	V	–	< 1.2	–	< 1.5 (for $I=0.1$ A)
Minimum load impedance				Ω	–	48	–	220
Output response time (1)				ms	–	1.2	–	1.2
Max. overload time before fault state				ms	–	15	–	15
Compatibility with IEC 1131-2 DC inputs				–	–	Yes (type 3, not IEC)	–	Yes (type 3, not IEC)
Paralleling of outputs				–	–	Yes (2 maximum)	–	Yes (3 maximum)
Switching frequency on inductive load				Hz	–	0.5/LI ²	–	0.5/LI ²
Built-in protection			Against overvoltages		–	Yes, by Transil diode	–	Yes, by Transil diode
			Against inversions		–	Yes, by reverse-mounted diode. Use a 2 A fuse on the preactuator + 24 V	–	Yes, by reverse-mounted diode. Use a 2 A fuse on the preactuator + 24 V
			Against short-circuits and overloads		–	Yes, by current limiter and electronic circuit-breaker 1.5 In < Id < 2 In	–	Yes, by current limiter and electronic circuit-breaker 0.125 A < Id < 0.185 A
Sensor and preactuator voltage control thresholds			OK	V	> 18			
			Fault		< 14			
Insulation resistance				M Ω	> 10 at 500 V $\overline{\text{---}}$			
Dielectric strength			Primary/secondary	Vrms	1,500 - 50/60 Hz for 1 minute			
			Between groups of inputs and outputs	V	500 $\overline{\text{---}}$			
			Outputs/ground or outputs/internal logic		–	1,500 - 50/60 Hz for 1 minute	–	1,500 - 50/60 Hz for 1 minute
Reliability			MTBF in hours	At T _{ambient} = 30°C	447,581		432,904	
Consumption			3.3 V $\overline{\text{---}}$	Typical	mA	79	125	
				Maximum	mA	111	166	
			24 V $\overline{\text{---}}$ preactuators (2)	Typical	mA	59	69	
				Maximum	mA	67	104	
Maximum dissipated power				W	3.7	4		
Temperature derating					None			

(1) All outputs are equipped with a fast demagnetization circuit for the electromagnets. Discharge time for the electromagnets < L/R.

(2) Excluding load current.

Modicon M340

automation platform

Discrete I/O modules



BMX DAI 1602



BMX DDI 3202K



BMX DDI 6402K

References

Discrete input modules

Type of current	Input voltage	Connection by (1)	IEC 1131-2 conformity	Modularity (no. of channels)	Reference	Weight kg	
=	24 V (positive logic)	Screw or spring-type 20-way removable terminal block	Type 3	16 isolated inputs	BMX DDI 1602	0.115	
		One 40-way connector	Type 3	32 isolated inputs	BMX DDI 3202K	0.112	
		Two 40-way connectors	Non-IEC	64 isolated inputs	BMX DDI 6402K	0.145	
=	24 V (negative logic)	Screw or spring-type 20-way removable terminal block	Non-IEC	16 isolated inputs	BMX DAI 1602 ▲	0.115	
		48 V (positive logic)	Screw or spring-type 20-way removable terminal block	Type 1	16 isolated inputs	BMX DDI 1603 ▲	0.115
~	24 V	Screw or spring-type 20-way removable terminal block	Type 1	16 isolated inputs	BMX DAI 1602 ▲	0.115	
		48 V	Screw or spring-type 20-way removable terminal block	Type 3	16 isolated inputs	BMX DAI 1603 ▲	0.115
		100...120 V	Screw or spring-type 20-way removable terminal block	Type 3	16 isolated inputs	BMX DAI 1604	0.115



BMX DDO 1602



BMX DRA 0805/1605



BMX DDO 3202K



BMX DDO 6402K

Discrete output modules

Type of current	Output voltage	Connection by (1)	IEC 1131-2 conformity	Modularity (no. of channels)	Reference	Weight kg
= solid state	24 V/0.5 A (positive logic)	Screw or spring-type 20-way removable terminal block	Yes	16 protected outputs	BMX DDO 1602	0.120
		Screw or spring-type 20-way removable terminal block	Non-IEC	16 protected outputs	BMX DDO 1612 ▲	0.120
	24 V/0.1 A (positive logic)	One 40-way connector	Yes	32 protected outputs	BMX DDO 3202K	0.110
		Two 40-way connectors	Yes	64 protected outputs	BMX DDO 6402K	0.150
~ triac	100...240	Screw or spring-type 20-way removable terminal block	–	16 outputs	BMX DAO 1605 ▲	0.140
= or ~ relay	12...24 V =/3 A, 24...240 V ~/3 A	Screw or spring-type 20-way removable terminal block	Yes	8 non-protected outputs	BMX DRA 0805	0.145
		Screw or spring-type 20-way removable terminal block	Yes	16 non-protected outputs	BMX DRA 1605	0.150

(1) By connector, module supplied with cover(s)

▲ Available 2nd quarter 2007

Modicon M340 automation platform

Discrete I/O modules



BMX
DDM 1602

BMX
DDM 3202K

References (continued)

Discrete mixed I/O modules

Number of I/O	Connection via (1)	No. and type of inputs	No. and type of outputs	IEC 1131 2 conformity	Reference	Weight kg
16	Screw or spring-type 20-way removable terminal block	8 (positive logic)	8, solid state 24 V $\overline{\text{---}}$ / 0,5 A	Inputs, type 3	BMX DDM 16022	0.115
			8, relay 24 V $\overline{\text{---}}$ or 24...240 V \sim	Inputs, type 3	BMX DDM 16025	0.135
32	One 40-way connector	16 (positive logic)	16, solid state 24 V $\overline{\text{---}}$ / 0,1 A	Inputs, type 3	BMX DDM 3202K	0.110



BMX FTB 2000

Removable connection blocks

Description	Use	Reference	Weight kg
20-way removable terminal blocks	Cage clamp	For module with 20-way removable terminal block	BMX FTB 2000
	Screw clamp	For module with 20-way removable terminal block	BMX FTB 2010
	Spring-type	For module with 20-way removable terminal block	BMX FTB 2020

Preformed cordsets for I/O modules with removable terminal block

Description	Composition	Length	Reference	Weight kg
Preformed cordsets with one end with flying leads	One 20-way terminal block	3 m	BMX FTW 301	0.850
	One end with color-coded flying leads	5 m	BMX FTW 501	1.400
		10 m	BMX FTW 1001	2.780



BMX FTW 01

Preformed cordsets for I/O modules with 40-way connectors

Description	No. of sheaths	Composition	Cross-section	Length	Reference	Weight kg			
Preformed cordsets with one end with flying leads	1 x 20 wires (16 channels)	One 40-way connector	0.324 mm ²	3 m	BMX FCW 301	0.820			
		One end with color-coded flying leads		5 m			BMX FCW 501	1.370	
				10 m			BMX FCW 1001	2.770	
	2 x 20 wires (32 channels)	One 40-way connector	0.324 mm ²	3 m	BMX FCW 303	0.900			
		Two ends with color-coded flying leads		5 m			BMX FCW 503	1.490	
				10 m			BMX FCW 1003	2.960	
Preformed cordsets for Telefast Advantys ABE 7 sub-bases	1 x 20 wires (16 channels)	One 40-way connector One HE 10 connector	0.324 mm ²	0.5 m	BMX FCC 051	0.140			
				1 m	BMX FCC 101	0.195			
				2 m	BMX FCC 201	0.560			
				3 m	BMX FCC 301	0.840			
				5 m	BMX FCC 501	1.390			
				10 m	BMX FCC 1001	2.780			
				2 x 20 wires (32 channels)	One 40-way connector Two HE 10 connectors	0.324 mm ²	0.5 m	BMX FCC 053	0.210
							1 m	BMX FCC 103	0.350
							2 m	BMX FCC 203	0.630
							3 m	BMX FCC 303	0.940
	5 m	BMX FCC 503	1.530						
	10 m	BMX FCC 1003	3.000						



BMX FCW 01



BMX FCW 03



BMX FCC 01

Input modules

BMX DDI 1602

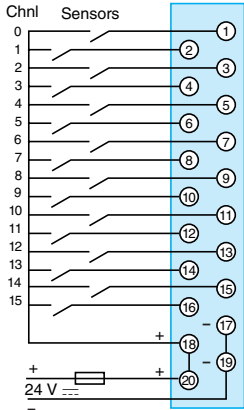

BMX DDI 3202K/6402K

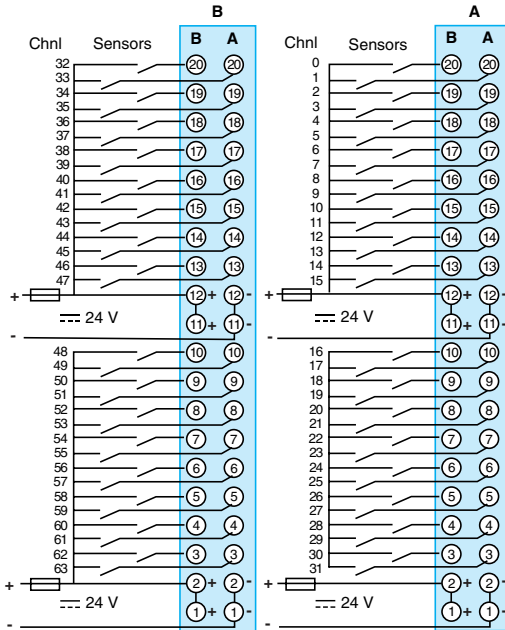

BMX DDI 1603

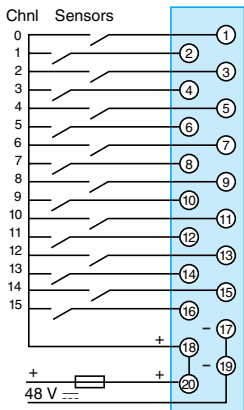

BMX DDI 3202K: Connector **A** (outputs I0...I32)

BMX DDI 6402K: Connector **A** (output I0...I32) and connector **B** (output I33...I63)

For correspondence of the FCN 40-way connector pins with the wire colors of

BMX FCW ●01/●03 prewired cordsets, in accordance with DIN 47100, see table on page 2/22.

BMX DAI 1602/1603/1604

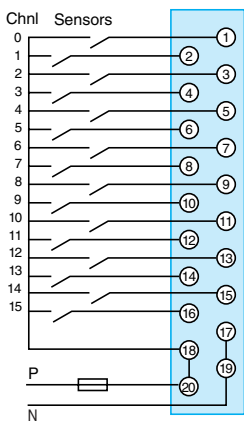

BMX DAI 1602, use in 24 V ~~, negative logic

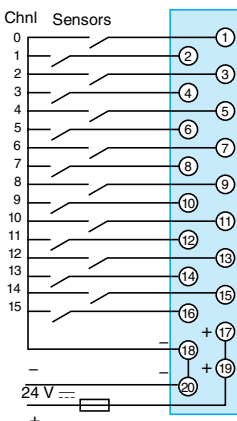

P-N voltage:

24 V ~: **BMX DAI 1602**

48 V ~: **BMX DAI 1603**

100/120 V ~: **BMX DAI 1604**

Output modules

BMX DDO 1602

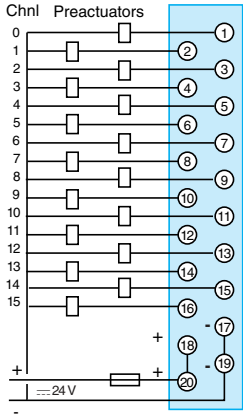

BMX DDO 1612

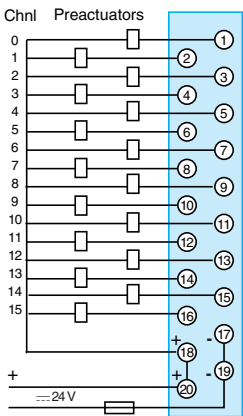

BMX DDO 3202K/6402K

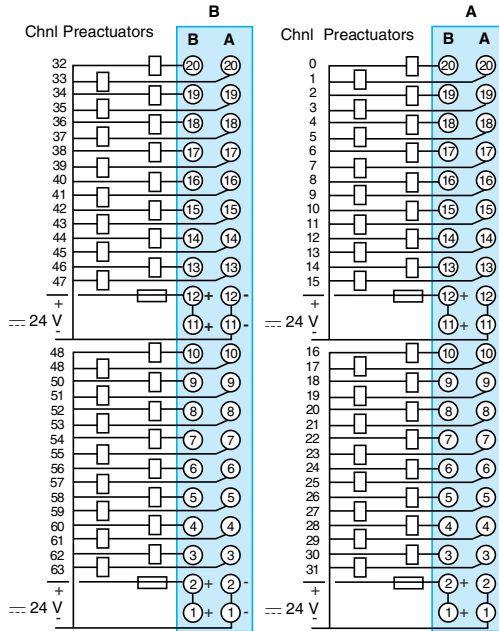

BMX DDO 3202K: Connector A (outputs Q0...Q32)

BMX DDO 6402K: Connector A (output Q0...Q32) and connector B (output Q33...Q63)

Note: For correspondence of the FCN 40-way connector pins with the wire colors of BMX FCW 001/003 prewired cordsets, in accordance with DIN 47100, see table on page 2/22.

BMX DAO 1605

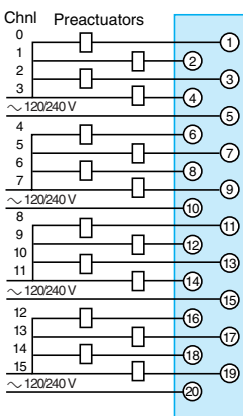

BMX DRA 0805

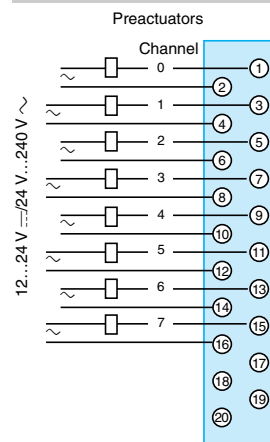

BMX DRA 1605

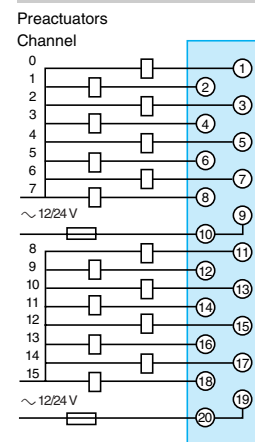

Mixed I/O modules

BMX DDM 16025

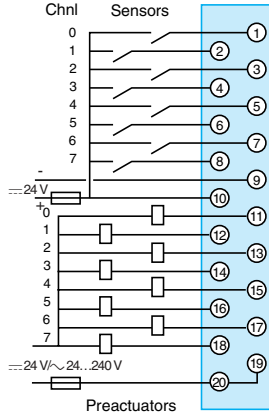

BMX DDM 16022

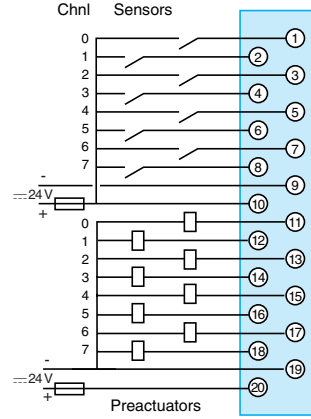

BMX DDM 3202K

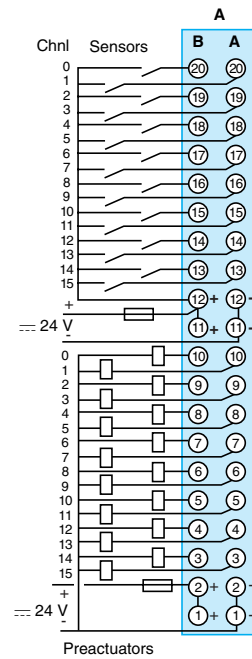

Modicon M340 automation platform

Discrete I/O modules

Cordset color codes in accordance with DIN 47100

Connection cables with 40-way connector and end(s) with flying leads BMX FCW ●01/●03

Correspondence of connector pins with the wire colors at the sheath end

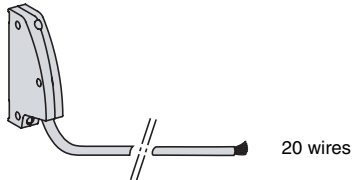

Cordset with one sheathed end with flying leads
BMX FCW ●01

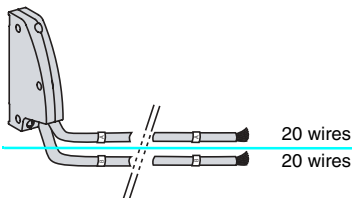

Cordset with two sheathed ends with flying leads
BMX FCW ●03

Connector pin no.	Color at sheath end	32/64-channel inputs	32/64-channel outputs	32-channel I/O
B20	White	Input 0/32	Output 0/32	Input 0
A20	Brown	Input 1/33	Output 1/33	Input 1
B19	Green	Input 2/34	Output 2/34	Input 2
A19	Yellow	Input 3/35	Output 3/35	Input 3
B18	Gray	Input 4/36	Output 4/36	Input 4
A18	Pink	Input 5/37	Output 5/37	Input 5
B17	Blue	Input 6/38	Output 6/38	Input 6
A17	Red	Input 7/39	Output 7/39	Input 7
B16	Black	Input 8/40	Output 8/40	Input 8
A16	Purple	Input 9/41	Output 9/41	Input 9
B15	Gray/pink	Input 10/42	Output 10/42	Input 10
A15	Red/blue	Input 11/43	Output 11/43	Input 11
B14	White/green	Input 12/44	Output 12/44	Input 12
A14	Brown/green	Input 13/45	Output 13/45	Input 13
B13	White/yellow	Input 14/46	Output 14/46	Input 14
A13	Yellow/brown	Input 15/47	Output 15/47	Input 15
B12	White/gray	+ 24 V	+ 24 V	+ 24 V
A12	Gray/brown	- 24 V	- 24 V	- 24 V
B11	White/pink	+ 24 V	+ 24 V	+ 24 V
A11	Pink/brown	- 24 V	- 24 V	- 24 V
B10	White	Input 16/48	Output 16/48	Output 0
A10	Brown	Input 17/49	Output 17/49	Output 1
B9	Green	Input 18/50	Output 18/50	Output 2
A9	Yellow	Input 19/51	Output 19/51	Output 3
B8	Gray	Input 20/52	Output 20/52	Output 4
A8	Pink	Input 21/53	Output 21/53	Output 5
B7	Blue	Input 22/54	Output 22/54	Output 6
A7	Red	Input 23/55	Output 23/55	Output 7
B6	Black	Input 24/56	Output 24/56	Output 8
A6	Purple	Input 25/57	Output 25/57	Output 9
B5	Gray/pink	Input 26/58	Output 26/58	Output 10
A5	Red/blue	Input 27/59	Output 27/59	Output 11
B4	White/green	Input 28/60	Output 28/60	Output 12
A4	Brown/green	Input 29/61	Output 29/61	Output 13
B3	White/yellow	Input 30/62	Output 30/62	Output 14
A3	Yellow/brown	Input 31/63	Output 31/63	Output 15
B2	White/gray	+ 24 V	+ 24 V	+ 24 V
A2	Gray/brown	- 24 V	- 24 V	- 24 V
B1	White/pink	+ 24 V	+ 24 V	+ 24 V
A1	Pink/brown	- 24 V	- 24 V	- 24 V

Connection cables with 20-way terminal block at one end and flying leads at the other BMX FTW ●01

Correspondence of 20-way removable terminal block pins with the wire colors (at sheath end)

Correspondence of terminal block pins with the wire colors at the sheath end

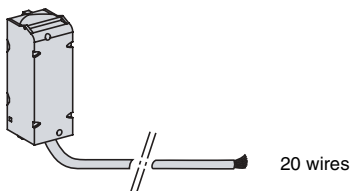

Cordset with 1 sheathed end with flying leads
BMX FTW ●01

Terminal block pin no.	Color at sheath end	16-channel inputs	8- or 16-channel outputs	16-channel I/O
1	White	Input 0	See page 2/20	Input 0
2	Brown	Input 1	See page 2/20	Input 1
3	Green	Input 2	See page 2/20	Input 2
4	Yellow	Input 3	See page 2/20	Input 3
5	Gray	Input 4	See page 2/20	Input 4
6	Pink	Input 5	See page 2/20	Input 5
7	Blue	Input 6	See page 2/20	Input 6
8	Red	Input 7	See page 2/20	Input 7
9	Black	Input 8	See page 2/20	Sensor + common power supply
10	Purple	Input 9	See page 2/20	Sensor pwr supply
11	Gray/pink	Input 10	See page 2/20	Output 0
12	Red/blue	Input 11	See page 2/20	Output 1
13	White/green	Input 12	See page 2/20	Output 2
14	Brown/green	Input 13	See page 2/20	Output 3
15	White/yellow	Input 14	See page 2/20	Output 4
16	Yellow/brown	Input 15	See page 2/20	Output 5
17	White/gray	Power supply	See page 2/20	Output 6
18	Gray/brown	+ common pwr sup.	See page 2/20	Output 7
19	White/pink	Power supply	See page 2/20	Preactuator pwr sup.
20	Pink/brown	Power supply	See page 2/20	Preactuator pwr sup.

Modicon M340 automation platform

Analog I/O modules

2

.2

Applications

Analog inputs



Type of I/O	
Type	
Range	Voltage
	Current
	Thermocouple, Temperature probe, Resistor
Modularity	
Acquisition period	
Conversion time	
Resolution	
Isolation	
Connection	Directly to the module
	Via preformed cordsets
Module	

Isolated low-level voltage inputs, resistors, thermocouples and temperature probes	
Multi-range	
± 40 mV, ± 80 mV, ± 160 mV, ± 320 mV, ± 640 mV and ± 1.28 V	
-	
Thermocouples type B, E, J, K, L, N, R, S, T, U Temperature probes type Pt 100, Pt 1000, Ni 100, Ni 1000 and Cu 10, 2- or 4-wire Resistors 2-, 3- or 4-wire, 400 Ω or 4,000 Ω	
4 channels	8 channels
400 ms for all 4 channels	400 ms for all 8 channels
-	
16 bits	
Between channels: 750 V --- Between channels and bus: 2,000 V --- Between channels and ground: 750 V ---	
Via 40-way connector	Via two 40-way connectors
BMX FCW ●01S cordsets with one end with color-coded flying leads (3 or 5 m long)	
BMX ART 0414	BMX ART 0814 ▲

Page

2/32



Compatibility with Advantys Telefast ABE 7 pre-wired system	
Type of module	Connection sub-base
	Preformed cordsets (1.5, 3 or 5 m long)

Sub-base with 4 channels for direct connection of 4 thermocouples plus connection and provision of cold-junction compensation	
ABE 7CPA412	
BMX FCA●●2	

Pages

5/16 and 2/32

▲ Available 2nd quarter 2007

Analog inputs

Analog outputs

Mixed analog I/O



Isolated high-level inputs	Isolated high-level outputs	Non-isolated high-level inputs	Non-isolated high-level outputs
Voltage/current	Voltage/current	Voltage/current	
± 10 V, 0...10 V, 0...5 V, 1...5 V, ± 5 V	± 10 V	± 10 V, 0...10 V, 0...5 V, 1...5 V	± 10 V
0...20 mA, 4...20 mA, ± 20 mA	0...20 mA, 4...20 mA	0...20 mA, 4...20 mA	0...20 mA, 4...20 mA
–	–	–	–
4 channels	2 channels	4 channels	2 channels
Fast: 1 + (1 x no. of declared channels) ms By default, 5 ms for all 4 channels	–	Fast: 1 + (1 x no. of declared channels) ms By default, 5 ms for all 4 channels	–
–	≤ 1 ms	–	≤ 1 ms
16 bits	16 bits	12 bits in 10 V range 10 bits in 20 mA range	12 bits
Between channels: 300 V $\overline{\text{---}}$ Between channels and bus: 2,000 V $\overline{\text{---}}$ Between channels and ground: 2,000 V $\overline{\text{---}}$	Between channels: 1,400 V $\overline{\text{---}}$ Between channels and bus: 2,000 V $\overline{\text{---}}$ Between channels and ground: 2,000 V $\overline{\text{---}}$	Between group of input channels and group of output channels: 1,400 V $\overline{\text{---}}$ Between channels and bus: 2,000 V $\overline{\text{---}}$ Between channels and ground: 2,000 V $\overline{\text{---}}$	

Via 20-way removable terminals (screw or spring-type)

BMX FTW ●01S cordsets with one end with color-coded flying leads (3 or 5 m long)

BMX AMI 0410

BMX AMO 0210

BMX AMM 0600 ▲

2/32



4-channel sub-base for direct connection of 4 inputs, delivers and distributes 4 protected isolated power supplies

ABE 7CPA410

BMX FCA●●0

5/16 and 2/32

Modicon M340 automation platform

Analog I/O modules

Presentation

The analog I/O module offer consists of:

- Three isolated analog input modules:
 - 4 analog high-speed channels (16 bits), voltage or current, **BMX AMI 0410**
 - 4 and 8 analog channels (15 bits + sign) for thermocouples, Pt, Ni or Cu temperature probes, **BMX ART 0414/0814**
- One analog output module with 2 voltage/current channels, **BMX AMO 0210**
- One mixed module (12 bits) with 4 analog input channels and 2 analog output channels, non-isolated, voltage or current, **BMX AMM 0600**

Analog I/O modules are equipped with a connector for a 20-way removable terminal block, except for **BMX ART 0414/0814** analog input modules with thermocouples/temperature probes, which are equipped with a 40-way connector.

All analog modules occupy a single slot in the **BMX XBP ●●●** racks. These modules can be installed in any slot in the rack, except the first two (PS and 00) reserved for the power supply module in the **BMX CPS ●●0** rack and the **BMX P34 ●●0** processor module respectively.

The power supply for the analog functions is supplied by the backplane bus (3.3 V and 24 V). Analog I/O modules are hot-swappable (see page 2/9).

In a Modicon M340 single-rack configuration, the maximum number of analog channels is limited by the number of slots available in the rack (11 slots maximum).

Description

BMX AM●/ART analog I/O modules are standard format (1 slot). They have a case, which ensures IP 20 protection of the electronics, and are locked into position by a captive screw.

I/O modules connected via 20-way removable terminal block

BMX AM● analog I/O modules have the following on the front panel:

- 2 A rigid body providing support and protection for the electronic card
- 3 A module reference marking (a label is also visible on the right-hand side of the module).
- 4 A module and channel status display block
- 5 A connector taking the 20-way removable terminal block, for connecting sensors or preactuators on screw or spring-type terminals

To be ordered separately:

- 6 A **BMX FTB 20●0** 20-way removable terminal block or preformed cordsets with 20-way terminal block at one end and flying leads at the other (**BMX FTW ●01S** or, with 25-way SUB-D connector, **BMX FCA ●●0**) for direct connection to Advantys Telefast ABE 7 sub-bases (see page 2/32).

I/O modules connected via 40-way connector

BMX ART 0●14 analog input modules have the following on the front panel:

- 1 A rigid body providing support and protection for the electronic card
- 2 A module reference marking (a label is also visible on the right-hand side of the module)
- 3 A module and channel status display block
- 4 A 40-way connector for connecting the sensors

To be ordered separately:

- 5 Preformed cordsets with 40-way connector at one end and flying leads at the other (**BMX FCW ●01S** or, with 25-way SUB-D connector, **BMX FCA ●●2**) for direct connection to Advantys Telefast ABE 7 sub-bases (see page 2/32).

To be ordered separately irrespective of the type of module:

- A shielding connection kit to protect against electrostatic discharge, consisting of a metal bar and two sub-bases for mounting on the rack supporting the analog modules
- A set of **STB XSP 3020** clamping rings for the shielding braids of analog signal cables.

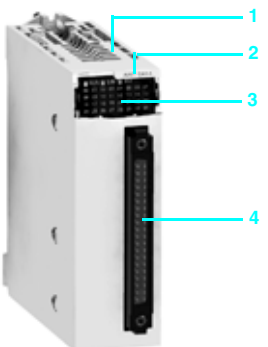
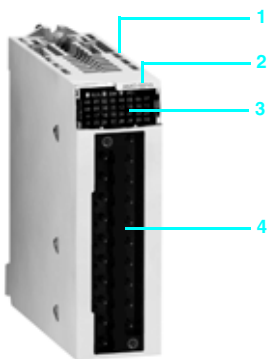

Modicon M340 automation platform

Analog I/O modules

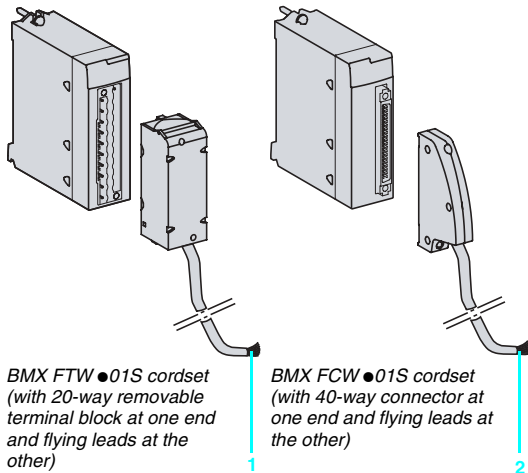

BMX FTW ●01S cordset (with 20-way removable terminal block at one end and flying leads at the other)

BMX FCW ●01S cordset (with 40-way connector at one end and flying leads at the other)

Connecting modules with removable terminal blocks

BMX AMI 0410/AMO 0210/AMM 0600 modules with 20-way terminal block

These 20-way removable terminal blocks are the same as those used for discrete I/O modules (screw clamp, cage clamp or spring-type). See page 2/8.

One version of the removable terminal block is equipped with a 3 or 5 m long cordset with color-coded flying leads (**BMX FTW●●S**). These preformed cordsets, with reinforced shielding have, at the other end **1**, color-coded flying leads conforming to standard DIN 47100.

Connecting modules with 40-way connectors

BMX ART 0●14 modules with 40-way connectors

Two types of cordset are available:

- Preformed cordsets with reinforced shielding (**BMX FCW ●01S**) have, at the other end **2**, color-coded flying leads conforming to standard DIN 47100. They are available in 3 or 5 m lengths, and provide easy direct wire-to-wire connection of the analog sensors via terminal blocks.
- Preformed cordsets with reinforced shielding (**BMX FCA ●●2**) which have at the other end **3**, a 25-way SUB-D connector. They are available in 1.5, 3 or 5 m lengths, and provide direct connection to the Advantys Telefast **ABE 7CPA412** sub-base (see below).

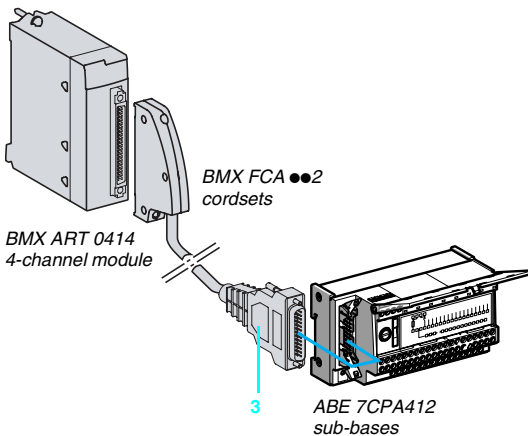

BMX ART 0414 4-channel module

BMX FCA ●●2 cordsets

ABE 7CPA412 sub-bases

Use with Advantys Telefast ABE 7 sub-bases

Using the Advantys Telefast ABE 7 pre-wired system makes it easier to install the modules since the inputs (or outputs) can be accessed using screw terminals. Two special sub-bases are available:

Advantys Telefast ABE 7CPA410 sub-base

The Advantys Telefast **ABE 7CPA410** sub-base is mainly used in conjunction with the **BMX AMI 0410** voltage/current analog 4-input module. It is used to:

- Connect the four sensors directly
- Remotely locate the input terminals in voltage mode
- Power the 4...20 mA conditioners one channel at a time with a 24 V voltage, protected and limited to 25 mA, while maintaining isolation between channels
- Protect the current impedance matching resistors integrated in the sub-base against overvoltages

Connection is via the **BMX FCA ●●0** cordset (1.5, 3 or 5 m long).

Advantys Telefast ABE 7CPA412 sub-base

The Advantys Telefast **ABE 7CPA412** sub-base is specially designed as a wiring interface for the **BMX ART 0414** and **BMX ART 0814** thermocouple modules. It is used to:

- Connect the four thermocouple probes
- Provide external cold-junction compensation with a temperature probe integrated in the sub-base
- Ensure continuity of the shielding

The **BMX ART 0814** module requires two Advantys Telefast **ABE 7CPA412** sub-bases. The connection with each sub-base is made via a **BMX FCA ●●2** cable (1.5, 3 or 5 m long).

Modicon M340 automation platform

Analog I/O modules

BMX AMI 0410 analog input modules

The **BMX AMI 0410** module is a high-level analog input module with 4 isolated inputs (16 bits).

Used with sensors or transmitters, it performs monitoring, measurement and process control functions for continuous processes.

For each input, the **BMX AMI 0410** module offers the following ranges:

- Voltage ± 10 V, ± 5 V, 0...10 V, 0...5 V and 1...5 V
- Current 0...20 mA, 4...20 mA and ± 20 mA, depending on the choice made during configuration

The module operates with voltage inputs. It includes four reading resistors connected to the terminal block to form the current inputs.

Functions

The **BMX AMI 0410** module includes the following functions:

- Adaptation and multiplexing:
 - Physical connection to the process
 - Protection of the module against overvoltages
 - Protection of the current reading resistors
 - Adaptation of input signals by analog filtering
 - Scanning of input channels by solid state multiplexing, by optical commutator switches
- Adaptation to input signals: Gain selection, drift compensation
- Conversion: 24-bit analog/digital converter
- Conversion of input measurements to a unit that is suitable for the user:
 - Taking account of the recalibration and alignment coefficients to be applied to measurements, as well as the module autocalibration coefficients
 - Measurement filtering, depending on the configuration parameters
 - Measurement scaling, depending on the configuration parameters
- Interface and communication with the application:
 - Receipt of the configuration parameters for the module and its channels
 - Transmission of measured values to the application, as well as module status
- Module power supply
- Module monitoring and indication of any faults to the application:
 - Conversion circuit test
 - Channel range overshoot test and watchdog test.

BMX ART 0414/0814 analog input modules

BMX ART 0414/0814 modules are multirange input modules with 4 or 8 low-level isolated inputs (15 bits + sign) respectively.

Depending on the choice made during configuration, the modules offer, for each of the inputs, the following range:

- Temperature probe: Pt100, Pt1000, Cu10, Ni100 or Ni1000, with open-circuit detection
- Thermocouple: B, E, J, K, L, N, R, S, T or U, with broken wire detection
- Resistor: 0...400 or 0...4000 Ω , 2-, 3- or 4-wire
- Voltage: ± 40 mV, ± 80 mV, ± 160 mV, ± 320 mV, ± 640 mV, ± 1.28 V.

Functions

BMX ART 0414/0814 modules offer the following functions

- Adaptation and current source per channel:
 - Accepting an overload of ± 7.5 V
 - Autocalibration of the analog module offset as close as possible to the input terminal
 - Selection of the cold-junction compensation sensor included in the Advantys Telefast **ABE 7 CPA412** sub-base or externally by the Pt 100 probe
- Adaptation to input signals: Based on a low offset amplifier internal to the A/D converter
- Conversion: 16-bit converter
- Conversion of input measurements to a unit that is suitable for the user:
 - Taking account of the recalibration and alignment coefficients to be applied to measurements, as well as the module autocalibration coefficients
 - Measurement filtering, depending on the configuration parameters
 - Measurement scaling, depending on the configuration parameters
- Interface and communication with the application:
 - Receipt of the configuration parameters for the module and its channels
 - Transmission of measured values to the application, as well as module status
- Module monitoring and indication of any faults to the application:
 - Conversion circuit test
 - Channel range overshoot test and watchdog test.

BMX AMO 0210 analog output module

The **BMX AMO 0210** module is a module with 2 high-level isolated outputs (15 bits + sign). It offers, for each of them, the ranges:

- Voltage: ± 10 V
- Current: 0...20 mA and 4...20 mA

The range is selected during configuration.

Functions

The **BMX AMO 210** module includes the following functions:

- Physical connection to the process
- Protection of the module against overvoltages
- Adaptation of the output signals:
 - Voltage or current adaptation by software configuration
 - Protection of the outputs against short-circuits and overloads
- Conversion to 15 bits with sign with redefinition of data
- Conversion of application values into data that can be used by the digital/analog converter:
 - Use of factory calibration parameters
- Interface and communication with the application:
 - Managing exchanges with the processor
 - Geographical addressing
 - Receipt of the configuration parameters for the module and its channels
 - Transmission of module status to the application
- Module monitoring and indication of any faults to the application:
 - Output power supply test
 - Channel range overshoot test
 - Output fault presence test
 - Watchdog test.

BMX AMM 0600 mixed analog I/O module

The **BMX AMM 0600** mixed module is an 11 bits + sign module with 4 inputs and 2 outputs, non-isolated between one another. It offers, for each of them, the ranges:

- Voltage: ± 10 V, 0...10 V, 0...5 V and 1...5 V
- Current: 0...20 mA and 4...20 mA.

Functions

The **BMX AMM 0600** module has the following functions:

- Protection of the module against overvoltages
- Adaptation to the different actuators: voltage or current output
- Conversion of digital signals (10 bits or 12 bits depending on the range) to analog signals
- Conversion of application data into data that can be used by the digital/analog converter
- Module monitoring and fault indication to the application: Converter test, range overshoot test, watchdog test.

Characteristics of BMX AMI 0410 analog input modules

Input module		BMX AMI 0410							
Input type		Isolated high-level inputs							
Number of channels		4							
Nature of inputs	Voltage	$\pm 10\text{ V}$, $0\dots 10\text{ V}$, $0\dots 5\text{ V}$, $1\dots 5\text{ V}$, $\pm 5\text{ V}$							
	Current	$0\dots 20\text{ mA}$, $4\dots 20\text{ mA}$, $\pm 20\text{ mA}$ (via protected internal $250\ \Omega$ resistors)							
Analog/digital conversion		16 bits							
Voltage/current range		$\pm 10\text{ V}$	$\pm 5\text{ V}$	$0\dots 5\text{ V}$	$0\dots 10\text{ V}$	$1\dots 5\text{ V}$	$0\dots 20\text{ mA}$	$4\dots 20\text{ mA}$	$\pm 20\text{ mA}$
Maximum conversion value		$\pm 11.4\text{ V}$					$\pm 30\text{ mA}$		
Resolution		0.35 mV					0.92 μA		
Input impedance	Typical	$\text{M}\Omega$							
		10 (irrespective of the input level)							
Permitted overload on the inputs	Voltage range	V							
	Current range	mA							
Voltage/current internal conversion resistor		W					250		
Precision of internal conversion resistor		-					0.1% - 15 ppm/ $^{\circ}\text{C}$		
Filtering		1 st order digital filtering							
Read cycle time	Fast	ms							
	Default	ms							
Measurement errors (1)	At 25°C	%FS					0.075%		
	Maximum at $0\dots 60^{\circ}\text{C}$	%FS					0.1%		
Temperature drift		15 ppm/ $^{\circ}\text{C}$					30 ppm/ $^{\circ}\text{C}$		
Recalibration		Internal							
Common mode between channels		dB							
Digital value format		120							
Isolation		$\pm 10,000$ by default, $\pm 32,000$ in user scale							
Isolation	Between channels	V							
	Between channels and bus	V							
	Between channels and ground	V							
Consumption	Typical	mA							
		See power consumption table page 6/8							

Characteristics of BMX ART 0414/0814 analog input modules

Input module		BMX ART 0414		BMX ART 0814	
Input type		Isolated inputs, low-level voltage, resistors, temperature probes, thermocouples			
Number of channels		4		8	
Nature of inputs		$\pm 40\text{ mV}$; $\pm 80\text{ mV}$; $\pm 160\text{ mV}$; $\pm 320\text{ mV}$; $\pm 640\text{ mV}$; $\pm 1.28\text{ V}$			
Analog/digital conversion		bits			
Resolution		$\Sigma \Delta 16$			
Filtering		15 + sign			
Read cycle time		1 st order digital filtering			
Permitted overload on the inputs		ms		ms	
50/60 Hz rejection		400 with temperature probes (1...4)		400 with temperature probes (1...8)	
		200 with thermocouples (1...4)		200 with thermocouples (1...8)	
Cold junction compensation		V		V	
		± 7.5		± 7.5	
Recalibration	Differential mode Typical	dB			
	Common mode Typical	dB			
Cold junction compensation		60			
Recalibration		120			
Isolation	External compensation by Pt100 probe	<input type="checkbox"/> Using the dedicated Advantys Telefast ABE 7CPA412 sub-base including the probe <input type="checkbox"/> Using a 2-wire thermocouple wired on channel 0 and/or 4 <input type="checkbox"/> Using a 3-wire temperature probe wired on channel 3 and/or 7			
	Between channels	Internal			
	Between channels and bus	V			
Consumption	Between channels and ground	V			
	Typical	mA			
		750			
		2,000			
		750			
		See power consumption table page 6/8			

(1) %FS: Error as a % of full scale
 (2) Including the conversion resistor error

Characteristics of BMX ART 0414/0814 analog input modules

Input ranges for BMX ART 0414/0814 modules

Voltage range			± 40 mV	± 80 mV	± 160 mV	± 320 mV	± 640 mV	± 1.28 V
Typical input impedance		MΩ	10					
Maximum conversion value			± 102.5%					
Maximum resolution		mV	40/2 ¹⁴	80/2 ¹⁴	160/2 ¹⁴	320/2 ¹⁴	640/2 ¹⁴	1280/2 ¹⁴
Measurement errors (1)	At 25°C	%FS	0.05					
	Maximum at 0...60°C	%FS	0.15					
Temperature drift		ppm/°C	30					
Resistor range			400 Ω			4,000 Ω		
Type			2-, 3- or 4-wire					
Maximum conversion value			± 100%					
Maximum resolution		mV	400/2 ¹⁴			4,000/2 ¹⁴		
Measurement errors (1)	At 25°C	%FS	0.12					
	Maximum at 0...60°C	%FS	0.2					
Temperature drift		ppm/°C	25					
Temperature probe ranges			Pt100	Pt1000	Cu10	Ni100	Ni1000	
Measurement range		°C	According to IEC: -200...+850 According to US/JIS: -100...+450		-100...+260	-60...+180		
Resolution		°C	0.1					
Detection type			Open circuit (detection on each channel)					
Measurement errors (1)	At 25°C (2)	°C	± 2.1		± 4	± 2.1	0.7	
	Maximum at 0...60°C	°C	± 2		± 4	± 3.0	1.3	
Max. wiring resistance	4-wire	Ω	50	500	50	500		
	2/3-wire	Ω	20	200	20	200		
Temperature drift			30 ppm/°C					
Thermocouple ranges			B	E	J	K	L	
Measurement range		°C	+130...+1820	-270...+1000	-200...+760	-270...+1370		-200...+900
Resolution		°C	0.1					
Detection type			Open circuit (detection on each channel)					
Measurement errors (1)	At 25°C	°C	± 3.5	± 3.7	± 2.8	± 3.7	± 3.0	
	Maximum at 0...60°C	°C	± 5	± 5	± 4.5	± 5	± 4.5	
Temperature drift		ppm/°C	25					
Thermocouple ranges (continued)			N	R	S	T	U	
Measurement range		°C	+270...+1300	-50...+1665	-50...+1665	-270...+400	-200...+600	
Resolution		°C	0.1					
Detection type			Open circuit (detection on each channel)					
Measurement errors (1)	At 25°C	°C	± 3.7	± 3.2	± 3.2	± 3.7	± 2.7	
	Maximum at 0...60°C	°C	± 5	± 4.5	± 4.5	± 5	± 4.5	
Temperature drift		ppm/°C	25					

(1) %FS: Error as a % of full scale. ± 1 °C with Pt100 temperature probe range, - 100...+ 200 °C
(2) Excluding error caused by the wiring

Characteristics of the BMX AMO 0210 analog output module

Module		BMX AMO 0210	
Output type		Isolated high-level outputs	
Number of channels		2	
Ranges	Voltage	± 10 V	
	Current	0...20 mA and 4...20 mA	
Resolution		bits	15 + sign
Conversion time		ms	≤ 1
Output power supply		Internal power supply via rack	
Output ranges		Voltage	
Adjustment range	Nominal	V	± 10 V
	Maximum	V	± 11.25 V
Load impedance		Ω	≥ 1,000
Detection type		Short-circuit	
Measurement errors (1)		At 25°C	
		%FS	0.10
		Maximum at 0...60°C	
		%FS	0.25
Temperature drift		40 ppm/°C	
Recalibration		None, factory-calibrated	
Fallback mode (2)		Default or configurable	
Isolation	Between channels	V rms	1,400 V ---
	Between channels and bus	V rms	2,000 V ---
	Between channels and ground	V rms	2,000 V ---
Consumption	Typical	mA	See power consumption table page 6/8

Characteristics of BMX AMM 0600 mixed analog I/O module

Module		BMX AMM 0600									
Channel type		Non-isolated high-level inputs						Non-isolated high-level outputs			
Number of channels		4						2			
Ranges		± 10 V	0...5 V	0...10 V	1...5 V	0...20 mA	4...20 mA	± 10 V	0...20 mA	4...20 mA	
Maximum conversion value	Voltage	V				± 11.25		± 11.25		–	
	Current	mA				–		–		0...24 mA	
Resolution		bits		12	10	11	10	10	12		
Filtering		1 st order digital filtering by firmware									
Precision of internal conversion resistor		250 Ω, 0.2% - 25 ppm/°C									
Read cycle time	Fast	ms						1 + 1 x no. of channels used (periodic reading of no. of declared channels)		–	
	Default	ms						5 for 4 channels		–	
Conversion time		ms						–		< 1	
Permitted overload on the input channels	Voltage	V				± 30		–		± 11.25	
	Current	mA				–		± 30		–	
Measurement errors (1)	At 25°C	%FS				0.3		0.6		–	
	Maximum at 0...60°C	%FS				0.5		1		–	
Temperature drift		80 ppm/°C				100 ppm/°C					
Recalibration		Internal						None, factory-calibrated			
Fallback mode (2)		–						Default or configurable			
Isolation	Between group of input channels and group of output channels	V						1,400 ---			
	Between channels and bus	V						2,000 ---			
	Between channels and ground	V						2,000 ---			
Consumption	Typical	mA						See power consumption table page 6/8			

(1) %FS: Error as a % of full scale

(2) Default: Output at 0 (V or mA). Configurable: Hold last value or set at predefined value for each channel.

Modicon M340 automation platform

Analog I/O modules



BMX AMI 0410



BMX ART 0414 BMX ART 0814



BMX FTB 2000



BMX FTW 01S



ABE 7CPA410



BMX FCA 01



BMX FCA 02

References

Analog input modules

Input type	Input signal range	Resolution	Connection	No. of channels	Reference	Weight kg
Isolated high-level inputs	± 10 V, 0...10 V, 0...5 V, 1...5 V, ± 5 V 0...20 mA, 4...20 mA, ± 20 mA	16 bits	Via cage clamp, screw clamp or spring-type removable terminal block	4 fast channels	BMX AMI 0410	–
Isolated low-level inputs	Temperature probe, thermocouple ± 40 mV, ± 80 mV, ± 160 mV, ± 320 mV, ± 640 mV, ± 1.28 V 0...400 Ω , 0...4000 Ω	15 bits + sign	40-way connector	4 channels 8 channels	BMX ART 0414 BMX ART 0814 ▲	– –

Analog output module

Output type	Output signal range	Resolution	Connection	No. of channels	Reference	Weight kg
Isolated high-level outputs	± 10 V, 0...20 mA, 4...20 mA	16 bits	Via cage clamp, screw clamp or spring-type removable terminal block	2 channels	BMX AMO 0210	–

Mixed analog I/O module

Channel type	Signal range	Resolution	Connection	No. of channels	Reference	Weight kg
Mixed I/O, non-isolated	± 10 V, 0...10 V, 0...5 V, 1...5 V, 0...20 mA, 4...20 mA	12 bits or 10 bits depending on the range	Via cage clamp, screw clamp or cage spring-type removable terminal block	I: 4 channels Q: 2 channels	BMX AMM 0600 ▲	–

Connection accessories for analog modules (1)

Description	For use with modules	Type, composition	Length	Reference	Weight kg
20-way removable terminal blocks	BMX AMI 0410	Cage clamp	–	BMX FTB 2000	–
	BMX AMO 0210	Screw clamp	–	BMX FTB 2010	–
	BMX AMM 0600	Spring-type	–	BMX FTB 2020	–
Preformed cordsets	BMX AMI 0410	One 20-way removable terminal block	3 m	BMX FTW 301S	–
	BMX AMO 0210		5 m	BMX FTW 501S	–
	BMX AMM 0600	One end with color-coded flying leads	–	–	–
	BMX ART 0414	One 40-way connector	3 m	BMX FCW 301S	–
BMX ART 0814 (2)	One end with color-coded flying leads	5 m	BMX FCW 501S	–	

Advantys Telefast ABE 7 pre-wired system

Advantys Telefast ABE 7 sub-bases	BMX AMI 0410	Distribution of isolated power supplies Delivers 4 protected isolated power supplies for 4...20 mA inputs Direct connection of 4 inputs	–	ABE 7CPA410	0.180
	BMX ART 0414 BMX ART 0814	Connection and provision of cold junction compensation for thermocouples Direct connection of 4 inputs	–	ABE 7CPA412	0.180
Preformed cordsets for ABE 7CPA sub-bases	BMX AMI 0410	One 20-way removable terminal block and one 25-way SUB-D connector for ABE 7CPA410 sub-base	1.5 m	BMX FCA150	–
			3 m	BMX FCA300	–
			5 m	BMX FCA500	–
	BMX ART 0414 BMX ART 0814	One 40-way connector and one 25-way SUB-D connector for ABE 7CPA412 sub-base	1.5 m 3 m 5 m	BMX FCA152 BMX FCA302 BMX FCA502	– – –

(1) The shielding on the cordsets carrying the analog signals must always be connected to the **BMX XSP 0000** shielding connection kit mounted under the rack holding the analog modules (see page 1/15).

(2) The **BMX ART 0814** 8-channel module requires two **ABE 7CPA412** sub-bases and two **BMX FCA 02** cordsets.

▲ Available 2nd quarter 2007

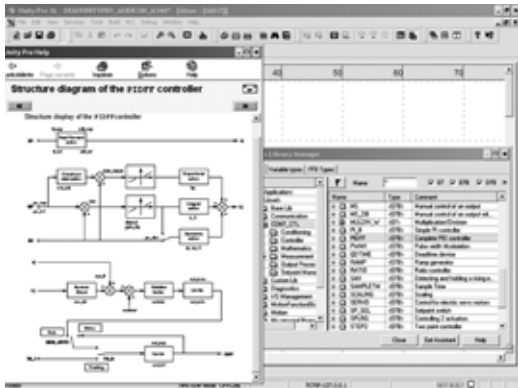

CONT_CTL, programmable process control integrated in Unity Pro

Process control in machines

Unity Pro contains CONT_CTL, a library of 36 function blocks used to create control loops for machine control.

All requirements for closed loop control functions in machines are adequately met by Modicon M340 thanks to the wealth of functions in the library and the flexibility with which function blocks can be linked together through programming. This solution therefore eliminates the need for external controllers, and simplifies the overall control architecture of the machine, as well as its design, roll-out and operation.

The function blocks, EF or EFB, can be used in all Unity Pro languages i.e. LD, ST, IL and FBD. FBD is particularly suitable for accessing control processing operations in Unity Pro through its assistant for entering and viewing parameters and function block variables.

CONT_CTL library functions

The library consists of five function families:

- Input data conditioning
- Controllers
- Math functions
- Measurement processing
- Output value processing

Input data conditioning

DTIME	Pure delay
INTEGRATOR	Integrator with limiting
LAG_FILTER	First order time lag device
LDLG	PD device with smoothing
LEAD	Differentiator with smoothing
MFLOW	Mass flow calculation based on the measurement of differential pressure or flow speed with pressure and temperature compensation
QDIME	Deadtime device
SCALING	Scaling
TOTALIZER	Integrator (typically of flow) until a limit (typically a volume) is reached, with automatic reset
VEL_LIM	Velocity limiter, with manipulated variable limiting

Controllers

PI_B	Simple PI controller: PI algorithm with a mixed structure (series/parallel)
PIDFF	Complete PID controller: PID algorithm with a parallel or mixed structure (series/parallel)
AUTOTUNE	Automatic tuner setting for the PIDFF (complete PID) controller or the PI_B (simple PI) controller <ul style="list-style-type: none"> □ Identification using Ziegler Nichols type method □ Modeling based on 1st order process □ Building of control parameters with criterion for prioritizing either the reaction time to disturbance (dynamic) or the stability of the process
IMC	Model corrector. The model is a first order model with delay. This corrector is useful: <ul style="list-style-type: none"> □ When there are serious delays compared with the main time constant of the process; this scenario cannot be satisfactorily resolved by standard PID process control □ For regulating a non-linear process IMC can handle any stable and aperiodic process of any order.
SAMPLETM	Control of controller startup and sampling
STEP2	Two-point controller
STEP3	Three-point controller for temperature regulation

Math functions

COMP_DB	Comparison of two values, with dead zone and hysteresis
K_SQRT	Square root, with weighting and threshold, useful for linearization of flow measurements
MULDIV_W	Weighted multiplication/division of 3 numerical values
SUM_W	Weighted summation of 3 numerical values

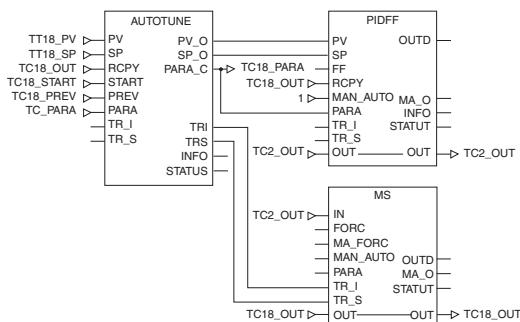

Example: PID controller with MS manual control

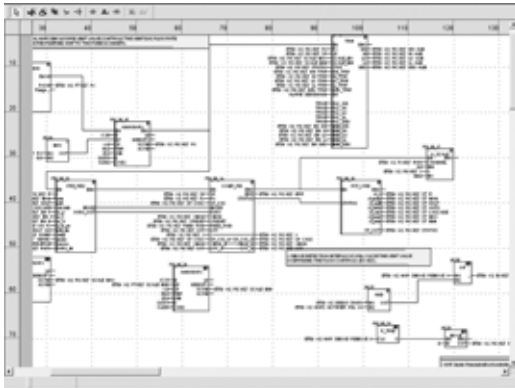

Programming in Unity Pro in offline mode

Measurement processing

AVGMV	Moving average with fixed number of samples (50 max.)
AVGMV_K	Moving average with constant correction factor, 10,000 samples max.
DEAD_ZONE	Dead zone
LOOKUP_TABLE1	Linearization of characteristic curves using first-order interpolation
SAH	Detection of a rising edge
HYST_XXX	Detection of high threshold with hysteresis (1)
INDLIM_XXX	Detection of high and low thresholds with hysteresis (1)

Output value processing

MS	Manual control of an output
MS_DB	Manual control of an output with dead zone
PWM1	Control via pulse width modulation
SERVO	Control for servo motors
SPLRG	Control of two <i>Split Range</i> actuators

Setpoint management

RAMP	Ramp generator, with separate ascending and descending ramps
RATIO	Ratio controller
SP_SEL	Selection of setpoint value: local (operator) or <i>remote</i> (processing)

Setting up process control function blocks

Based on the sequencing of function blocks, the FBD language integrated into Unity Pro is a programming language particularly suitable for building control loops. Designers can use FBD to easily associate blocks from the CONT_CTL library with their own DFB blocks written in Unity Pro's ST, IL or LD language, or in C language.

Debugging, operation

All Unity Pro's standard debugging services (see page 4/21) are available. In particular, the Modicon M340 processor simulator can be used to check correct execution of processing offline.

Compatibility

The CONT_CTL control function block library is available in all versions of Unity Pro. It is compatible with all processors in the Modicon M340, Premium, Quantum, and Atrium ranges.

Resources

The technical documentation provides many examples of how to set up programmable process control function blocks in FBD, LD, IL and ST languages.

The techniques for adjusting process control loops are described in the document "Process control, Unity V3.0" available on the www.telemecanique.com website.

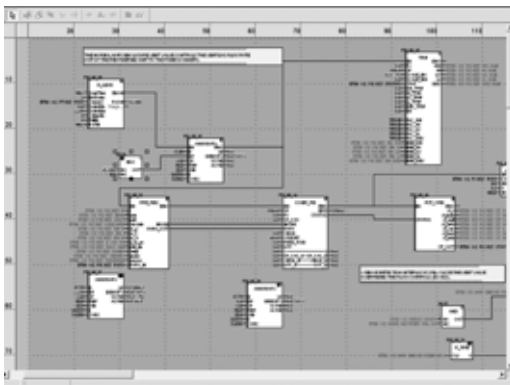

Programming in online mode

(1) XXX depending on the type of variable: DINT, INT, UINT, UDINT, REAL

Modicon M340 automation platform

Distributed I/O system

2

.3

Splitter box and module type

Monobloc I/O splitter boxes
Advantys FTB



Type of communication with Modicon M340 platform

CANopen

Max. number per connexion points

1 monobloc splitter

Discrete inputs/outputs	Number of channels
	Input voltage
	Output voltage

Splitter of 16 I, 8 I + 8 O, 12 I + 4 O, 16 I/O or 8 I + 8 I/O
 --- 24 V
 --- 24 V

Analogue inputs/outputs

–

Counting

–

Type of input/output connectors

M12 connectors

Housing type

Plastic and metal

Module type

FTB 1

Pages

Consult our catalogue “IP 67 splitter boxes”

Monobloc IP 20 distributed I/O

Optimum IP 20 distributed I/O

Modular IP 20 distributed I/O

Modicon Momentum

Advantys OTB

Advantys STB



Ethernet TCP/IP

Ethernet TCP/IP
CANopen
Modbus (RS 485)

Ethernet TCP/IP
CANopen

1 base with 1 communicator

1 interface module

1 "NIM" interface module + 32 I/O modules

Base of 16 I, 32 I, 8 O, 16 O, 32 O, 10 I/8 O,
16 I/8 O, 16 I/12 O et 16 I/16 O

12 I/8 O

Module of 2 I, 4 I, 6 I, 16 I, 2 O, 4 O, 6 O or 16 O

== 24 V, ~ 120 V et ~ 230 V

== 24 V

== 24 V, ~ 115 V and ~ 230 V

== 24 V, ~ 120 V and ~ 230 V and relay

== 24 V and relay

== 24 V, ~ 115/230 V and relay

Bases 8 I, 16 I or 4 O voltage/current
Base 4 I thermocouple or RTD

–

Modules 2 I and 2 O voltage/current
Module 2 I thermocouple or RTD

Base 2 channels 10 kHz/200 kHz

Integrated in interface module:
- 2 channels 5 kHz/20 kHz
- 2 PWM function channels

Module 1 channel 40 kHz

Base 6 I/3 O ~ 120 V with 1 Modbus port

–

Parallel interface module for TeSys Quickfit and
TeSys U motor-starters

Screw or spring terminal blocks

Removable screw terminal blocks

Screw or spring connectors

Plastic

170 AD●

OTB 1●O DM9LP

STB D●●/A●●

Consult our catalogue
"Modicon Momentum automation platform"

Consult our catalogue
"Advantys OTB distributed I/O"

Consult our catalogue
"Advantys STB distributed I/O"

Modicon M340 automation platform

BMX EHC 0200/0800 counter modules

Presentation

BMX EHC 0200 and **BMX EHC 0800** counter modules for the Modicon M340 automation platform are used to count the pulses generated by a sensor or to process the signals from an incremental encoder.

The two modules differ in the number of counter channels, maximum input frequencies, functions and auxiliary input and output interfaces:

Counter module	No. of channels	Maximum frequency	Integrated functions	No. of physical inputs	No. of physical outputs
BMX EHC 0200	2	60 kHz	Upcounting Downcounting Period meter Frequency meter Frequency generator Axis control	6	2
BMX EHC 0800	8	10 kHz	Upcounting Downcounting Measurement Interface	2	–

The sensors used on each channel can be:

- 2-wire 24 V proximity sensors
- 3-wire 24 V proximity sensors
- 10/30 V output signal incremental encoders with push-pull outputs

BMX EHC 0200 / 0800 counter modules can be used to meet the demands of applications such as:

- Alarm generation on empty unwinder status using the ratio
- Sorting small parts using the period meter
- Single electronic cam using the dynamic setting thresholds
- Speed control using the period meter

These standard format modules can be installed in any available slot of a Modicon M340 PLC; they can be removed while powered up.

In a Modicon M340 PLC configuration, the number of **BMX EHC 0200 / 0800** counter modules should be added to the number of application-specific modules: communication, motion control and weighing.

The function parameters are set by configuring the Unity Pro software.

Description

BMX EHC 0200 / 0800 analog I/O modules are standard format. They occupy a single slot in **BMX XBP ●●00** racks.

They come in a plastic case, which ensures IP 20 protection of the electronics, and locks into position with a screw.

BMX EHC 0200 module, 2 channels, 60 kHz

The **BMX EHC 0200** counter module has the following on the front panel:

- 1 Module and channel status LED array
- 2 16-way connector for wiring the sensors of counter 0
- 3 16-way connector for wiring the sensors of counter 1
- 4 10-way connector for wiring:

- the auxiliary outputs
- the sensor power supplies

To be ordered separately:

- A **BMX XTS HSC 20** kit containing:
 - Two 16-pin connectors
 - One 10-pin connector
- A **BMX XSP 010** electromagnetic compatibility kit.

BMX EHC 0800 module, 8 channels, 10 kHz

The **BMX EHC 0800** counter module has the following on the front panel:

- 1 Module and channel status LED array
- 2 20-way connector compatible with discrete I/O

To be ordered separately: a **BMX XSP 010** electromagnetic compatibility kit.

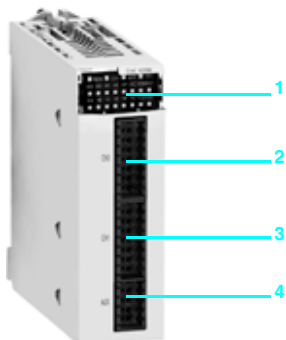

BMX EHC 0200

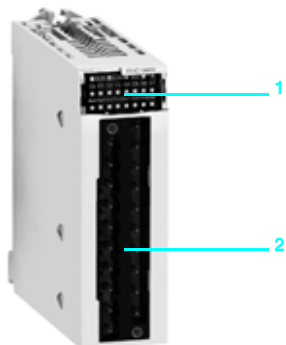

BMX EHC 0800

Operation

Block diagram of a BMX EHC 0200 module counter channel

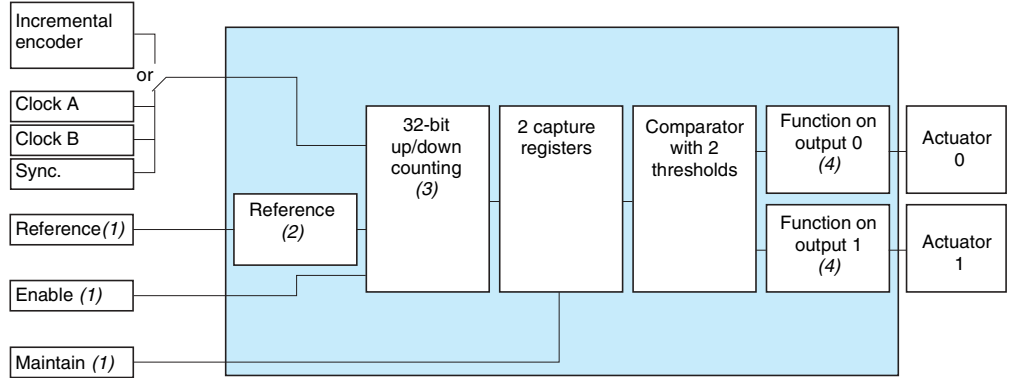

- (1) Optional.
- (2) Reference: 5 operating modes for IN_SYNC and IN_REF inputs.
- (3) Counting: 8 modes, see page 2/38.
- (4) Functions: 11 possible types of behavior.

Block diagram of a BMX EHC 0800 module counter channel

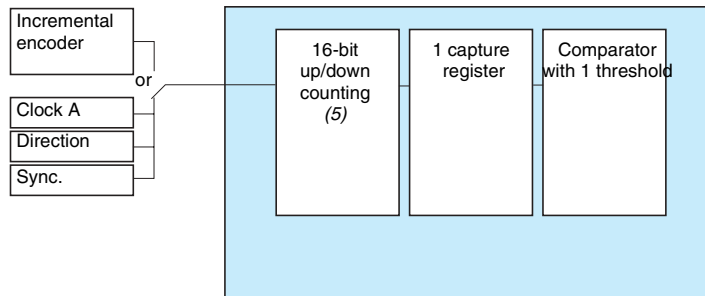

- (5) BMX EHC 0800 counting: 7 modes, see page 2/39.

Functional characteristics of the BMX EHC 0200 module

Configurable functions	Frequency meter	This function measures a frequency, speed, data rate or an event stream. As standard, this function measures the frequency received on the IN A input. This frequency is always expressed in Hz (number of pulses per second), with a precision of 1 Hz. The maximum frequency on the IN A input is 60 kHz. The maximum cyclic ratio at 60 kHz is 60%.
	Count events	This function is used to determine the number of events received intermittently. In this mode, the counter calculates the number of pulses applied to the IN_A input, at time intervals defined by the user. As an option, it is possible to use the IN_SYNC input during a period of time, provided that the enable bit has indeed been configured. The module counts the pulses applied to the IN_A input each time the pulse for this input lasts longer than 5 µs (without anti-bounce filter). IN_A input pulses that have appeared for less than 100 ms after a change of state of the IN_SYNC input are lost.
	Measure time periods	This function is used to: <ul style="list-style-type: none"> ■ determine how long an event lasts for ■ determine the time that separates 2 events ■ time and measure the execution time of a process Measures the elapsed time during an event or between two events (IN_A input) according to a selectable time base of 10 µs, 100 µs or 1 ms. The IN_SYNC input can be used to enable or stop a measurement. The module can carry out a maximum of 1 measurement every 5 ms. The smallest measurable pulse is 100 µs, even if the unit defined by the user is 10 µs. The maximum measurable duration is 4,294,967,295 units (1) (unit to be defined).
	Ratio count	The ratio count mode only uses the IN_A and IN_B inputs. This count mode consists of 2 modes: <ul style="list-style-type: none"> ■ Ratio 1: used to divide 2 frequencies and useful in applications such as flowmeters and mixers, for example. ■ Ratio 2: used to subtract 2 frequencies and useful in the same applications but requiring more precise regulation (more similar frequencies). Ratio 1 mode presents the results in thousandths in order to have better accuracy (a display of 2000 corresponds to a value of 2) and ratio 2 mode presents the results in Hz. The maximum frequency that the module can measure on the IN_A and IN_B inputs is 60 kHz. The maximum measurable value is 4,294,967,295 units (1).
	Downcounting	This function is used to list a group of operations. In this mode, activation of the synchronization function starts the counter which, starting with a preset value, decreases on each pulse applied to the IN_A input, until it reaches the value 0. This downcounting is made possible when the enable function has been activated. The counting register is thus updated at intervals of 1 ms. One basic use of this mode is to signal, using an output, the end of a group of operations (when the counter reaches 0). The smallest pulse applied to the IN_SYNC input is 100 µs. The frequency applied to the IN_SYNC input is at maximum 1 pulse every 5 ms. The maximum value of the preset value is 4,294,967,295 (1). The maximum count value is 4,294,967,295 units (1).
	Loop (modulo) counting	This function is used in packaging and labeling applications where actions are repeated on series of moving objects. In the counting direction, the counter increases until it reaches the preset modulo value. On the next pulse, the counter is reset to 0 and counting restarts. In the downcounting direction, the counter decreases until it reaches the value 0. On the next pulse, the counter is reset to the preset modulo value. Downcounting can then restart. The maximum frequency applied to the IN_A and IN_B inputs is 60 kHz. The smallest pulse applied to the IN_SYNC input is 100 µs. The frequency applied to the IN_SYNC input is at maximum 1 pulse every 5 ms. The frequency of the modulo event is at maximum 1 every 5 ms. The maximum modulo and counter value is 4,294,967,295 (1).
	32-bit counter counting	This function is used mainly in axis following. The maximum frequency applied simultaneously to the IN_A and IN_B inputs is 60 kHz. The smallest pulse applied to the IN_SYNC input is 100 µs. The frequency of the referencing event is at maximum 1 every 5 ms. The counter value is between - 2,147,483,647 and + 2,147,483,647 (2).
	Width modulation	In this operating mode, the module uses an internal clock generator to supply a periodic signal on the module output Q0. Only the Q0 output is affected by this mode, the Q1 output being independent of this mode. Control of the Q0 output must be at 1 to enable modulation on the Q0 output. The maximum output frequency value is 4 kHz. The frequency applied to the IN_SYNC input is at maximum 1 pulse every 5 ms. As the Q0 output is source type, a load resistor is needed for the Q0 output signal to change to 0 at the correct frequency. The cyclic ratio adjustment range varies according to the frequency of the Q0 output.

(1) If the measurement value exceeds 2,147,483,647 units then the application must convert the measurement naturally to a signed integer (DINT) or an unsigned integer (UINT).

(2) The counter value is a signed integer (DINT) which must not be converted to an unsigned integer (UINT).

Functional characteristics of the BMX EHC 0800 module

Configurable functions	Frequency meter	<p>This function measures a frequency, speed, rate or data stream control. As standard, this function measures the frequency received on the IN A input. This frequency is always expressed in Hz (number of pulses per second), with a precision of 1 Hz.</p> <p>The maximum frequency on the IN A input is 60 kHz. The maximum cyclic ratio at 60 kHz is 60%.</p>
	Count events	<p>This function is used to determine the number of events received intermittently. In this mode, the counter calculates the number of pulses applied to the IN_A input, at time intervals defined by the user.</p> <p>As an option, it is possible to use the IN_AUX input during a period of time, provided that the enable bit has indeed been configured.</p> <p>The module counts the pulses applied to the IN_A input each time the pulse for this input lasts longer than 50 µs (without anti-bounce filter). Pulses with less than 100 ms synchronization are lost.</p>
	Downcounting	<p>This function is used to list a group of operations.</p> <p>In this mode, when counting is enabled (software validation via the valid_sync command), a rising or falling edge on the IN_AUX input causes a value, defined by the user, to be loaded in the counter. The latter decreases on each pulse applied to the IN_A input, until it reaches the value 0. Downcounting is made possible when the force_enable command is high (software positioning).</p> <p>The smallest pulse applied to the IN_AUX input is 100 µs. The frequency applied to the IN_AUX input is at maximum 1 pulse every 25 ms.</p>
	Loop (modulo) counting	<p>This function is used in packaging and labeling applications where actions are repeated on series of moving objects.</p> <p>The counter increases on each pulse applied to the IN_A input, until it reaches the preset modulo value. On the next pulse in the upcounting direction, the counter is reset to 0 and upcounting restarts.</p> <p>The maximum frequency applied to the IN_A input is 10 kHz. The smallest pulse applied to the IN_AUX input varies according to the selected filter level. The frequency applied to the IN_AUX input is at maximum 1 pulse every 25 ms. The frequency of the modulo event is at maximum 1 every 25 ms. The minimum acceptable modulo value varies according to the frequency of the IN_A input. For example, for a frequency of 10 kHz applied to the IN_A input, the modulo must be higher than 250.</p>
	Up/down counter	<p>This function is used for an accumulation, upcounting or downcounting operation on a single input.</p> <p>Each pulse applied to the IN_A input produces:</p> <ul style="list-style-type: none"> ■ upcounting of pulses if the IN_AUX input is high ■ downcounting of pulses if the IN_AUX input is low <p>The counter values vary between the limits -65,536 and +65,535. The maximum frequency applied to the IN_A input is 10 kHz. Pulses applied to the IN_A input, after a change of direction, are only upcounted or downcounted after a period corresponding to the delay for taking account of the state of the IN_AUX input due to the programmable filter level on this input.</p>
	32-bit counter counting	<p>32-bit counter counting mode is available for channels 0, 2, 4, and 6 (channels 1, 3, 5 and 7 are now inactive). It behaves in the same way as the up/down counting mode using up to 3 physical inputs. It enables simultaneous upcounting and downcounting.</p> <p>The counter values vary between the limits -2,147,483,648 and +2,147,483,647 (31-bit word and 1 sign bit).</p> <p>The eight 16-bit registers can be configured as four 32-bit registers. The maximum frequency applied to the IN_A and IN_B inputs is 10 kHz. The smallest pulse applied to the IN_AUX input is defined according to the filtering applied to this input. The frequency of loading the preset value is at maximum 1 every 25 ms.</p>

2

2.

Modicon M340 automation platform

BMX EHC 0200/0800 counter modules

2

.4

General characteristics				
Type of module		BMX EHC 0200	BMX EHC 0800	
Modularity		2 channels	8 channels	
Number of physical inputs per module		6	2	
Number of physical outputs per module		2	–	
Application		Upcounting, downcounting, measurement, frequency meter, frequency generator, axis following	Upcounting, downcounting, measurement, interfacing	
Frequency on counter inputs		kHz max. 60	max. 10	
Module cycle time		ms 1	5	
Number of inputs/outputs per counter channel	Inputs	Number	6	
		Type	V 24 ---, Type 3	
	Outputs	Number	2	
		Type	V 24 ---	
Encoder		10...30 V incremental encoder model with push-pull outputs		
Power supply	Sensor voltage	V 19.2...30 ---		
	Actuator current	A 0.5 max. per output 2 per module	–	
Distribution of power to the sensors		Yes. Short-circuit and overload protection, 300 mA typical	–	
Hot swapping		Yes, in certain conditions: the module can be removed and reinserted in its slot while the rack is powered up, but the counter may need to be re-enabled when it is reinserted in its base.		
Insulation voltage from the ground to the bus		V 1500 for 1 min		
Consumption Typical		mA	See power consumption table page 6/8	
Input characteristics				
Module type		BMX EHC 0200	BMX EHC 0800	
Input type		High-speed inputs (IN_A, IN_B, IN_SYNC) and auxiliary inputs (IN_EN, IN_REF, IN_CAP)	High-speed inputs (IN_A, IN_B, IN_AUX)	
Number of inputs per channel		6, 24 V ---	2, 24 V ---	
Inputs	Voltage	V	30 ---	
		At state 1	Voltage V 11...30 --- Current mA 6 (24 V ---)	
	At state 0	Voltage V	< 5 ---	
		Current mA	< 1.5	
	Current at 11 V ---		mA	> 2
	Characteristics of outputs			
Output type		BMX EHC 0200	BMX EHC 0800	
Number of outputs per channel		2, 24 V ---, 0.5 A	–	
Voltages		V 19.2...30 ---	–	
Maximum load current	Each point	A 0.5	–	
	Per module	A 1	–	
Maximum leakage current at state 0		mA 0.1	–	
Maximum voltage drop at state 1		V < 3	–	
Maximum short-circuit output current		Each point A 1.5	–	
Maximum load capacity		µs < 200	–	
Short-circuit and overload		Protection for each channel		
Polarity on each output channel	Default	Normal logic on both channels		
	User configuration	Reverse logic on one or more channels		
Inductive load		The inductive load is calculated by application of the formula: $L = 0.5/I^2 \times F$ where: □ L: load inductance in Henrys □ I: load current in amps □ F: switching frequency in Hz		

Modicon M340 automation platform

BMX EHC 0200/0800 counter modules



BMX EHC 0200



BMX EHC 0800



BMX FTB 2000

References

BMX EHC 0200/0800 counter modules

Description	No. of channels	Characteristics	Reference (1)	Weight kg
Counter modules for 2 and 3-wire 24 V \pm sensors and 10/30 V \pm incremental encoders with push-pull outputs	2	Counting at 60 kHz	BMX EHC 0200	0.112
	8	Counting at 10 kHz	BMX EHC 0800	0.113

Connection accessories (1)

Description	Composition Use	Unit reference	Weight kg
Connector kit	Two 16-pin connectors and one 10-pin connectors for BMX EHC 0200 module	BMX XTS HSC 20	0.021
20-way removable terminals blocks For BMH EHC 0800 module	Cage clamp	BMX FTB 2000	0,093
	Screw clamp	BMX FTB 2010	0,075
	Spring-type	BMX FTB 2020	0,060
Electromagnetic compatibility kits For BMX EHC 0200/0800 modules	Comprising: a metal bar, two sub-bases and one set of spring clamping rings	See page 1/15	–

(1) The shielding on the cordsets carrying the analog signals must always be connected to the **BMX XSP000** shielding connection kit mounted under the rack holding the analog modules (see page 1/15).

Connections

Pinout for the BMX EHC 0200 module 16-pin connector

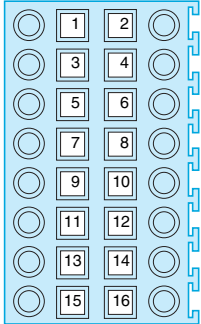

Pin number	Symbol	Description
1, 2, 7, 8	24V_SEN	24 V $\overline{\text{---}}$ output for the sensor power supply
5, 6, 13, 14	GND_SEN	0 V $\overline{\text{---}}$ output for the sensor power supply
15, 16	FE	Functional earth
3	IN_A	Input A
4	IN_SYNC	Synchronization input
9	IN_B	Input B
10	IN_EN	Enable input
11	IN_REF	Referencing input
12	IN_CAP	Capture input

Pinout for the BMX EHC 0200 module 10-pin connector

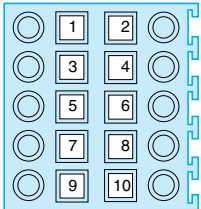

Pin number	Symbol	Description
1	24V_IN	24 V $\overline{\text{---}}$ input for the input power supply
2	GND_IN	0 V $\overline{\text{---}}$ input for the input power supply
5	Q0-1	Q1 output of counter channel 0
6	Q0-0	Q0 output of counter channel 0
7	Q1-1	Q1 output of counter channel 1
8	Q1-0	Q0 output of counter channel 1
9	24V_OUT	24 V $\overline{\text{---}}$ input for the output power supply
10	GND_OUT	0 V $\overline{\text{---}}$ input for the output power supply

Examples of connection to the BMX EHC 0200 module

Sensor connections

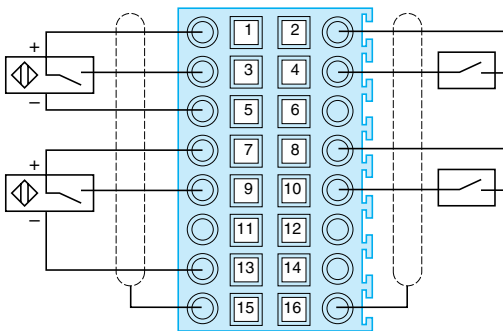

Connection of an incremental encoder

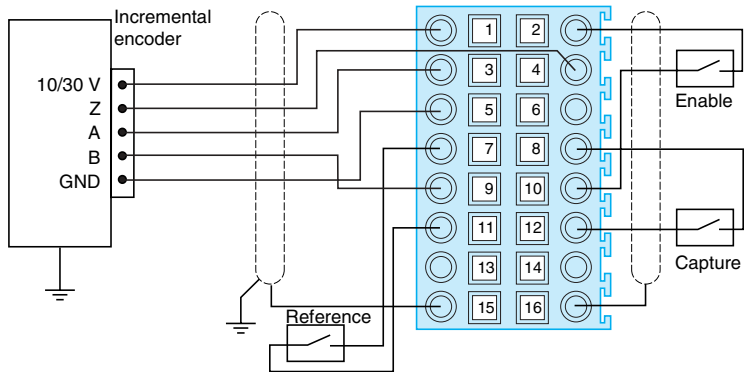

Connection of power supplies and actuators (1)

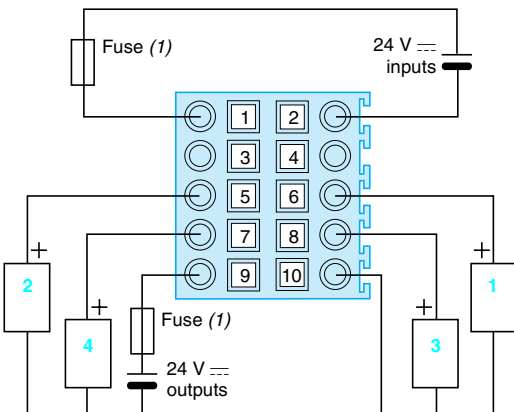

- 1 Actuator for Q0 output of counter channel 0
- 2 Actuator for Q1 output of counter channel 0
- 3 Actuator for Q0 output of counter channel 1
- 4 Actuator for Q1 output of counter channel 1

(1) A fast-blow fuse should be used to protect the module electronics in the event of reversed polarity of the power supplies on the inputs and outputs.

Connections (continued)

Pinout for the connector for the BMX EHC 0800 module 20-way terminal block

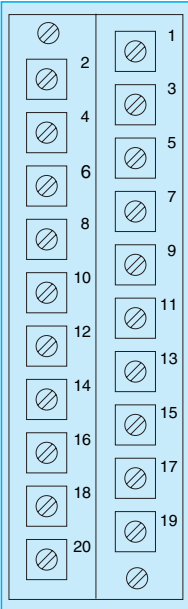

Pin number	Description
1	IN_AUX input of channel 0
2	IN_A input of channel 0
3	IN_AUX input of channel 1
4	IN_A input of channel 1 or IN_B input of channel 0
5	IN_AUX input of channel 2
6	IN_A input of channel 2
7	IN_AUX input of channel 3
8	IN_A input of channel 3 or IN_B input of channel 2
9	IN_AUX input of channel 4
10	IN_A input of channel 4
11	IN_AUX input of channel 5
12	IN_A input of channel 5 or IN_B input of channel 4
13	IN_AUX input of channel 6
14	IN_A input of channel 6
15	IN_AUX input of channel 7
16	IN_A input of channel 7 or IN_B input of channel 0
17	Feedback - 24 V power supply for sensors
18	VDC + Power supply for sensors
19	Functional earth, for shielding connection
20	Functional earth, for shielding connection

Examples of connection to the BMX EHC 0800 module

Connection of sensors (1) (2) (3)

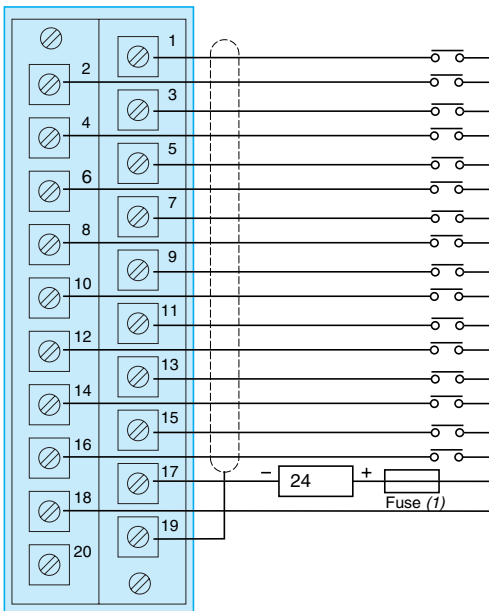

Connection of an incremental encoder (1) (2) (3) (4)

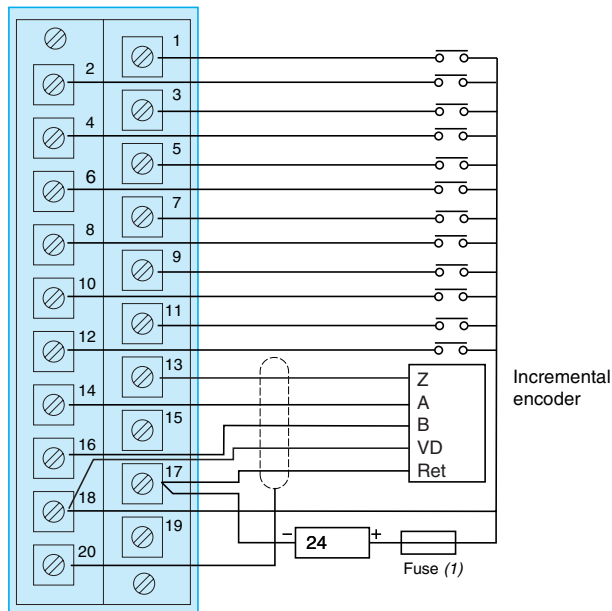

- (1) It is advisable to adapt the programmable filtering to the frequency applied to the inputs since using programmable filtering avoids the need to use a shielded cable.
- (2) In the case of an encoder or a high-speed sensor without programmable filtering, it is advisable to use a shielded cable connected to pins 15 and 16 of the connector.
- (3) In the case of a very disturbed environment without programmable filtering, it is advisable to use the **BMX XSP 010** electromagnetic protection kit to connect the shielding. In this case it is also advisable to use a 24 V power supply dedicated to the inputs as well as a shielded cable for connecting the power supply to the module.
- (4) A fast-blow fuse should be used to protect the module electronics in the event of reversed polarity of the power supplies.

2

.4

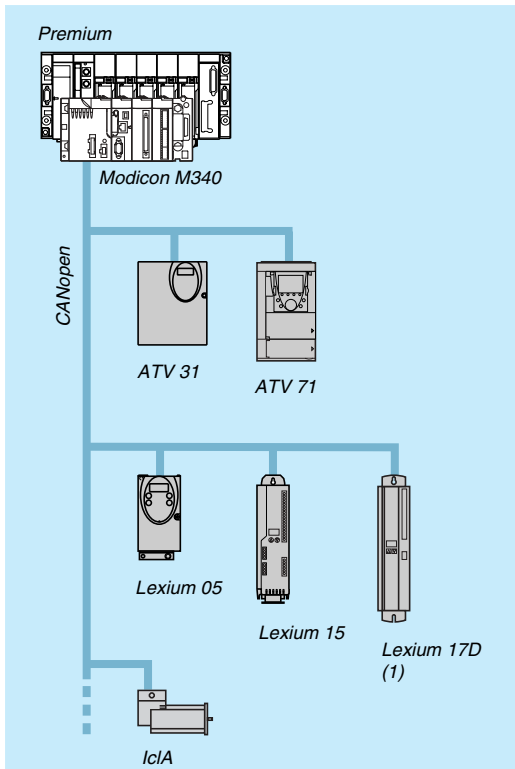

MFB: Motion control distributed over CANopen



Presentation

MFB (Motion Function Blocks) is a library of function blocks integrated in Unity Pro used to set up motion control in the architectures of drives and servo drives on machine buses and CANopen installations:

- Altivar 31: For asynchronous motors from 0.18 to 15 kW
- Altivar 71: For asynchronous motors from 0.37 to 500 kW
- Lexium 05: For servo motors from 0.4 to 6 kW
- Lexium 15LP/MP/HP: For BSH and BDH servo motors from 0.9 to 42.5 kW
- Lexium 17D: For BPH, BPL and SER servo motors from 1.5 to 70 A rms (1)
- IclA IFA/IFE/IFS: For integrated motor drives from 0.05 to 0.25 kW

In compliance with PLCopen specifications, the MFB library allows both easy and flexible motion programming with Unity Pro, as well as axis diagnosis. In maintenance operations, drives can be replaced quickly and safely thanks to drive parameter download blocks.

Setting up drives on the CANopen network is facilitated through Motion Tree Manager organization in the Unity Pro browser, making it easy for users to access the application drives.

Applications

The features of the Motion Function Blocks library are particularly suitable for machines with independent axes. In the case of these modular/special machines, MFB function blocks are the perfect solution for controlling single axes. The following are typical applications for this type of architecture:

- Automatic storage/removal
- Handling
- Palletizers/depalletizers
- Conveyors
- Packaging, simple label application
- Grouping/ungrouping
- Adjustment axes in flexible machines, etc.

Functions

The table below lists the function blocks of the MFB library and the drives compatible with them. The prefix indicates the block family:

- MC: Function block defined by the Motion Function Blocks PLCopen standard
- TE: Function block specific to Telemecanique products
- Lxm: Function block specific to Lexium servo drives

Type	Function	Function block	Altivar		Lexium		IclA
			ATV 31	ATV 71	05	15/17D (1)	
Management and motion	Read an internal parameter	MC_ReadParameter					
	Write an internal parameter	MC_WriteParameter					
	Read the current position	MC_ReadActualPosition					
	Read the instantaneous speed	MC_ReadActualVelocity					
	Acknowledge error messages	MC_Reset					
	Stop all active movement	MC_Stop					
	Axis coming to standstill	MC_Power					
	Movement to absolute position	MC_MoveAbsolute					
	Relative movement	MC_MoveRelative					
	Additional movement	MC_MoveAdditive					
	Homing	MC_Home					
	Movement at given speed	MC_MoveVelocity					
	Read diagnostic data	MC_ReadAxisError					
	Read servo drive status	MC_ReadStatus					
Save and restore parameters (FDR)	Read all parameters and store in PLC memory	TE_UploadDriveParam					
	Write all parameters from the PLC memory	TE_DownloadDriveParam					
Advanced Lexium functions	Set the reduction ratio	Lxm_GearPos				(2)	
	Read a motion task	Lxm_UploadMTask					
	Write a motion task	Lxm_DownloadMTask					
	Start a motion task	Lxm_StartMTask					
System	Communication with the servo drive	TE_CAN_Handler					

Compatible

(1) Lexium 17D supported by MFB with Modicon Premium platform only

(2) Function not supported by Lexium 15 LP servodrives

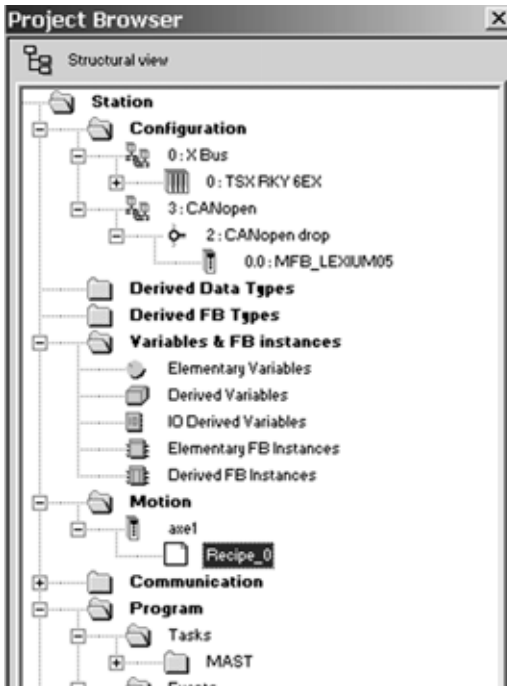

Motion Tree Manager integrated in the Unity Pro browser

Motion Tree Manager

Motion Tree Manager is associated with Unity Pro's MFB library, and integrated in its browser. It provides specific assistance for:

- Axis object management
- Axis variable definition
- Drive parameter management

Motion Tree Manager automatically creates links between the CANopen bus configuration and the MFB function block data using a limited amount of configuration data.

General axis parameters

In this tab, the designer is prompted to define:

- The name of the axis that will identify it in the browser for the entire application
- The address of the drive on the CANopen bus

Axis parameters

The dropdown lists in this tab are used to determine the exact type of drive: family, version.

Variable names

This last tab is used to identify data structures:

- **Axis Reference**, used by all the instances of function blocks for the axis in question
- **CAN_Handler**, used to manage communication with the drive via the CANopen network

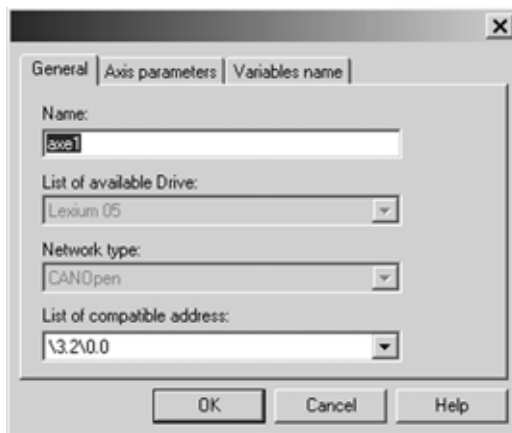

General parameters: Axis name and address

Recipe definition

The "recipes" attached to the axis are the data structures containing all the adjustment parameters of a given drive. This data is used when:

- Changing the drive with restoration of the context during "Faulty Device Replacement" maintenance
- Changing the manufacturing program of the machine, and calling up an appropriate set of parameters, such as servo control gains, limitations etc. adapted to the weight and size of the moving parts.

Programming, diagnostics and maintenance

Communication between the PLC and drive is automatically set up by the system as soon as a TE_CAN_Handler instance is declared in the Unity Pro task with which the axis is associated.

Movements are then programmed by sequencing function blocks from the library in the Unity Pro editor as selected by the user (LD, ST, FBD).

The two function blocks, MC_ReadStatus, and in some cases MC_ReadAxisError, are useful for determining the overall status of the axis, and the code of active warnings or errors.

The function blocks TE_UploadDriveParam and TE_DownloadDriveParam allow the application to save all the parameters of a drive (recipe) and to then quickly reload them into another drive if the first one fails.

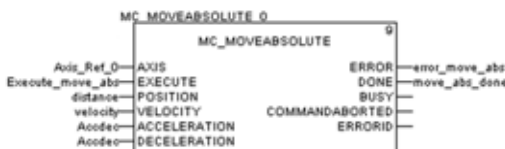

MFB: Programming a movement in absolute mode

Communication selection guide page 3/2

3.1 - Ethernet TCP/IP networks - Transparent Ready

- Embedded Web services page 3/4
- Ethernet TCP/IP communication services page 3/6
- Performances page 3/14
- Ethernet integrated port / module selection page 3/20
- Ethernet processor/module product data sheet page 3/22
- ConneXium cabling system page 3/24

3.2 - CANopen machines and installations bus

- Presentation page 3/36
- Description page 3/38
- Characteristics page 3/38
- References page 3/39
- Cabling system page 3/40

3.3 - Serial links

- Modbus and character mode serial link page 3/42
- Cabling system page 3/44



Modicon M340 automation platform

Communication, integrated ports and modules

3

Applications

Processors with integrated Ethernet TCP/IP port

Ethernet TCP/IP module



Type

Structure	Physical interface
	Connector type
	Access method
	Data rate

Medium

Configuration	Maximum number of devices
	Maximum length
	Number of links of the same type per station
	Other integrated port

Standard services

Conformity class

Embedded Web server services	Standard services
	Configurable services

Transparent Ready communication services	I/O Scanning service
	FDR service
	SNMP network management service
	Global Data service
	SMTP e-mail notification service
	Passband management

Compatibility with processor

Processor or module

Page

Ethernet TCP/IP

10BASE-T/100BASE-TX
RJ45
CSMA-CD
10/100 Mbps

Double twisted pair copper cable, category CAT 5E
Optical fiber via ConneXium wiring system

-	
100 m (copper cable), 4,000 m (multi-mode optical fiber), 32,500 m (single-mode optical fiber)	
1 (integrated port)	1 (Ethernet module) with BMX P34 1000/2010 processor 2 (integrated port et Ethernet module) with BMX P34 2020/2030 processor
Serial link	CANopen bus
	-

Modbus TCP/IP messaging

Transparent Ready class B10	Transparent Ready class B30	Transparent Ready class C30
"Rack viewer" PLC diagnostics "Data editor" access to PLC data and variables		
-	-	"Alarm viewer" "Graphic Data Editor"
-	-	Hosting and display of user Web pages (16 Mb)

No	Yes
Yes (client)	Yes (server)
Yes	
No	Yes
No	
Yes	

- Standard and Performance processors

BMX P34 2020	BMX P34 2030	BMX NOE 0100	BMX NOE 0100 + BMXRWS 016MC
---------------------	---------------------	---------------------	------------------------------------

3/22 3/23

Processors with integrated machine and installation bus

Processors with integrated serial link



CANopen

ISO 11898 (9-way SUB-D connector)
 9-way SUB-D
 CSMA/CA (multiple access)
 20 Kbps...1 Mbps depending on distance

Double shielded twisted pair copper cable

63
 20 m (1 Mbps)...2,500 m (20 kbps)
 1

Serial link Ethernet TCP/IP

- PDO implicit exchange (application data)
 - SDO explicit exchange (service data)
 Class M20

-

-

-

-

-

-

-

-

-

-

-

-

BMX P34 2010

BMX P34 2030

Modbus and Character mode

Non-isolated, 4-wire RS 232/2-wire RS 485
 RJ45
 Master/slave with Modbus link,
 Half duplex (RS 485)/Full duplex (RS 232) in character mode
 0.3...19.2 Kbps

Double shielded twisted pair copper cable

32 per segment, 247 max.
 15 m (non-isolated), 1,000 m with insulating case
 1

- CANopen Ethernet TCP/IP

Read/write bits and words, diagnostics with Modbus link
 Send and receive character string in character mode

-

-

-

-

-

-

-

-

-

-

-

-

BMX P34 1000

BMX P34 2010

BMX P34 2020

Modicon M340 automation platform

Ethernet TCP/IP network, Transparent Ready
Web services

Overview of the Web services

In conformity with Schneider Electric Ethernet products (processors and Ethernet modules on Modicon automation platforms, distributed I/O modules, variable speed drives and gateways), standard Web services are integrated in **BMX P34 2020/2030** processors and the **BMX NOE 0100** Ethernet network module on the Modicon M340 platform.

From a simple Internet browser, the standard Web server authorizes the following “ready-to-use” functions:

- Product configuration
- Remote diagnostics and maintenance of products
- Display and adjustment of products (read/write variables, status)

With the **BMX NOE 0100** Ethernet network module equipped with the **BMX RWS C016M** memory card, the Web server also offers the following functions:

- Management of PLC alarms (system and application) with partial or total acknowledgement (ready-to-use Alarm Viewer function pages).
- Hosting and display of Web pages created by the user.

The embedded Web server is a realtime data server. All the data can be presented in the form of standard Web pages in HTML format and can therefore be accessed using any Web browser that supports the embedded Java code. The standard functions provided by the Web server are supplied “ready-to-use” and thus do not require any programming of either the PLC or the client PC device supporting a Web browser.

Standard Web server on the Modicon M340 platform

Rack Viewer PLC diagnostics function

The Rack Viewer function can be used for PLC system and I/O diagnostics. It displays the following in realtime:

- LED status on the front panel of the PLC
- The PLC type and version
- The hardware configuration of the PLC including the status of the system bits and words
- Detailed diagnostics of each of the I/O module channels (1) or application-specific channels in the configuration



Modicon M340 hardware configuration

Data Editor read/write function for PLC data and variables

The Data Editor function can be used to create tables of animated variables for realtime read/write access to PLC data in the form of lists.

Various animation tables containing specific application variables to be monitored or modified can be created by the user and saved in the standard Web server module.

In addition to the standard Web server, the Web server in the **BMX NOE 0100** Ethernet network module equipped with the **BMX RWS C016M** memory card offers the option of displaying the variables, and they can be entered and displayed either symbolically (2) (S_Pump 234) or depending on their address (%MW99).

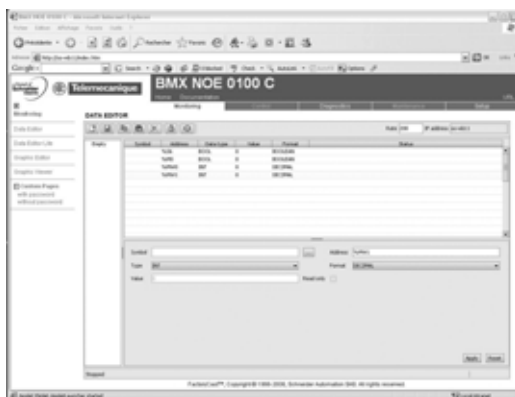

Data editor variables table

(1) Function available 2nd quarter 2007.

(2) Access to symbols available 2nd quarter 2007. Hence provides access to unlocated data.

Modicon M340 automation platform

Ethernet TCP/IP network, Transparent Ready Web services



Alarm display from the diagnostic buffer

BMX NOE 0100 Ethernet module Web server

With the **BMX NOE 0100** Ethernet network module equipped with the **BMX RWS C016M** memory card (to be ordered separately), the Web server offers, in addition to the standard Web services, the functions below.

Alarm Viewer function (1)

Alarm Viewer (1) is a ready-to-use, password-protected function. This function can be used to process alarms (display, acknowledgment and deletion) managed at PLC level by the system or using diagnostic function blocks known as DFBs (system-specific diagnostic function blocks and application-specific diagnostic function blocks created by the user).

These alarms are stored in the diagnostic buffer managed by the Modicon M340 platform (special memory space for storing all the diagnostics events).

The diagnostics viewer is a Web page comprising a list of messages, which displays the following information for each alarm:

- Dates and times of the occurrence/removal of a fault
- Alarm message
- Alarm status
- Type of associated diagnostic function block (DFB)

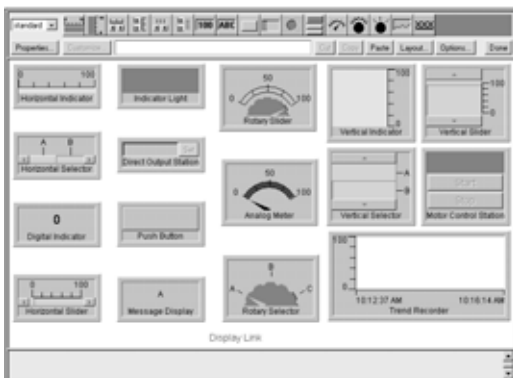

Library of predefined graphic objects

Graphic Data Editor function

This function is used to create the graphic views animated by the PLC variables that can be accessed via their address (access to located data). The ready-to-use graphic editor is available online, connected to the **BMX NOE 0100** module.

These views are created from a library of predefined graphic objects by simple copy/paste operations. The objects are configured to suit the user's requirements (color, PLC variables, name, etc).

List of proposed graphic objects:

- Analog and digital indicators
- Horizontal and vertical bar charts
- Boxes for displaying messages and entering values
- Pushbutton boxes
- Functions for recording trends
- Vats, valves, motors, etc

Customized graphic objects can be added to this list. They can be reused in user Web pages that have been created using standard software for editing HTML pages. The views thus created are saved in the **BMX NOE 0100** module.



Realtime supervision graphic interface

User Web page hosting and display function

The **BMX NOE 0100** Ethernet network module, via the **BMX RWS C016M** card, has a 16 Mbyte non-volatile memory (accessible as a hard disk). This allows hosting of Web pages and any user-defined Word or Acrobat Reader document (for example, maintenance manuals, wiring diagrams, etc).

These Web pages can be created using any standard tool for creation and editing in HTML format. These pages can be enhanced by inserting animated graphic objects linked to PLC variables. These animated objects are created using the Graphic Data Editor. They are then downloaded to the **BMX NOE 0100** module via an FTP utility, such as "WSFTP" for example.

The Web pages created can be used, for example, to:

- Display and modify all PLC variables in real time
 - Create hyperlinks to other external Web servers (documentation, suppliers, etc)
- This function is particularly suitable for creating graphic interfaces used for the following purposes:
- Realtime display and supervision
 - Production monitoring
 - Diagnostics and help with maintenance
 - Operator guides

(1) Function available 2nd quarter 2007.

Modicon M340 automation platform

Ethernet TCP/IP network, Transparent Ready
Ethernet TCP/IP communication services

Presentation

BMX P34 2020 / 2030 processors, via their integrated Ethernet port (class 10) and the **BMX NOE 010** network module (class 30) provide transparent communication on a single Ethernet TCP/IP network.

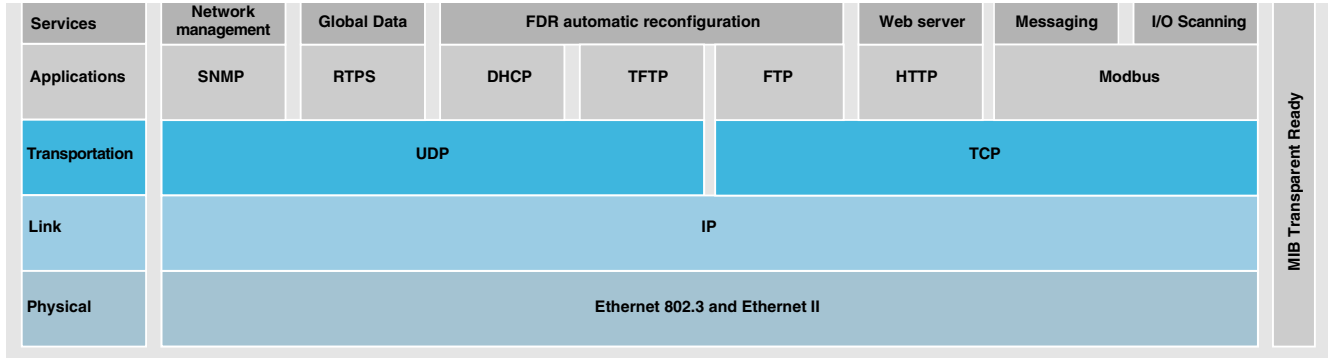

In addition to universal Ethernet services (HTTP, BOOTP/DHCP, FTP, etc) and with the Modicon M340 automation platform, the Transparent Ready device communication services designed for use in automation applications include:

- Modbus TCP/IP messaging for class 10 or 30 devices
- I/O Scanning service for class 30 devices
- FDR (Faulty Device Replacement) for class 10 or 30 devices
- SNMP (*Simple Network Management Protocol*) network management for class 10 or 30 devices
- Global Data, for class 30 devices
- Bandwidth management for class 10 or 30 devices

The following pages present the various options available through all of these services in order to facilitate the optimum choice of solutions when defining a system integrating Transparent Ready devices.

Modicon M340 automation platform

Ethernet TCP/IP network, Transparent Ready
Ethernet TCP/IP communication services

Functions

Ethernet universal services

HTTP "HypTocol" (RFC1945)

The HTTP protocol (*HyperText Transfer Protocol*) is a protocol used to transmit Web pages between a server and a browser. HTTP has been used on the Web since 1990.

Web servers embedded in Transparent Ready automation products provide easy access to products located anywhere in the world from a standard Internet browser such as Internet Explorer or Netscape Navigator.

BOOTP/DHCP (RFC1531)

BOOTP/DHCP is used to supply devices with IP parameters automatically. This avoids having to manage each device address individually by transferring this management to a dedicated IP address server.

The DHCP protocol (Dynamic Host Configuration Protocol) is used to assign configuration parameters to devices automatically. DHCP is an extension of BOOTP. The DHCP protocol consists of 2 components:

- One to supply the IP network address.
- One to supply the specific IP parameters to the device from a DHCP server.

Telemecanique devices can be:

- *BOOTP clients used to retrieve the IP address automatically from a server.*
- *BOOTP servers allowing the device to distribute IP addresses to the network stations.*

Telemecanique has used BOOTP/DHCP standard protocols to offer the FDR (Faulty Device Replacement) service.

FTP "File Transfer Protocol" (RFCs 959, 2228, and 2640)

File Transfer Protocol (FTP) provides the basic elements for file sharing. The FTP protocol is used by several systems to exchange files between devices.

TFTP "Trivial File Transfer Protocol" (updated firmware)

Trivial File Transfer Protocol (TFTP) is a network transfer protocol used to connect to a device and download code to it.

For example, it can be used to transfer a boot code to a workstation without a disk drive or to connect and download updates of network device firmware.

Note: *Transparent Ready devices implement FTP and TFTP to transfer certain information to or from products, in particular for downloads of firmware or user-defined Web pages.*

Modicon M340 automation platform

Ethernet TCP/IP network, Transparent Ready
Ethernet TCP/IP communication services

Functions (continued)

Ethernet universal services (continued)

SNMP "Simple Network Management Protocol" (RFCs 1155, 1156 and 1157)

The Internet community has developed the SNMP standard in order to manage the various network components via a single system. The network management system can exchange data with SNMP agent devices. This function allows the manager to display the status of the network and products, modify their configuration and feed back alarms in the event of a fault.

Note: Transparent Ready products are compatible with SNMP and can be integrated naturally in a network administered via SNMP.

COM/DCOM "Distributed Component Object Model"

COM/DCOM (Distributed Component Object Model) or OLE (Object Linking and Embedding) is the name of the technology consisting of Windows objects which enables transparent communication between Windows applications.

Note: These technologies are used in the OFS (OLE for Process Control Factory Server) data server software.

3
1

Modicon M340 automation platform

Ethernet TCP/IP network, Transparent Ready Ethernet TCP/IP communication services

Modbus TCP/IP function codes		dec	hex
Bit access	Read n input bits	02	02
	Read n output bits	01	01
	Read exception status	07	07
	Write 1 output bit	05	05
	Write n output bits	15	0F
	Read 1 input word	04	04
	Read n input words	03	03
	Write 1 output word	06	06
	Write n output words	16	10
	Read device ID	43/14	2B/0E

Examples of Modbus TCP/IP function codes for accessing data and diagnostics.

Functions (continued)

Modbus standard communication protocol

Modbus, the industry communication standard since 1979 has been brought together with Ethernet TCP/IP, the medium for the Internet revolution, to form Modbus TCP/IP, a totally open protocol on Ethernet. The development of a connection to Modbus TCP/IP does not require any proprietary component, nor purchase of a license.

This protocol can easily be combined with any product supporting a standard TCP/IP communication stack. The specifications can be obtained free of charge from the following Web site: www.modbus-ida.org.

Modbus TCP/IP, simple and open

The Modbus application layer is very simple and universally familiar with its 9 million installed connections. Thousands of manufacturers are already using this protocol. Many have already developed a Modbus TCP/IP connection and numerous products are presently available.

The simplicity of Modbus TCP/IP enables any field device, such as an I/O module, to communicate on Ethernet without the need for a powerful microprocessor or lots of internal memory.

Modbus TCP/IP, high-performance

Due to the simplicity of its protocol and the fast speed of 100 Mbps Ethernet, the performance of Modbus TCP/IP is excellent. This allows this type of network to be used in realtime applications such as I/O scanning.

Modbus TCP/IP, a standard

The application protocol is identical on serial link Modbus, Modbus Plus or Modbus TCP/IP. This means that messages can be routed from one network to the other without converting protocol.

Since Modbus is implemented on top of the TCP/IP layer, users can also benefit from IP routing enabling devices located anywhere in the world to communicate without worrying about the distance between them.

Schneider Electric offers a complete range of gateways for connecting a Modbus TCP/IP network to existing Modbus Plus networks, a Modbus serial link or AS-Interface bus. Please consult your Regional Sales Office.

The IANA organization (Internet Assigned Numbers Authority) has allocated the fixed port TCP 502 ("Well known" port) to the Modbus protocol. Thus Modbus has become an Internet standard.

A study by the ARC Advisory Group, the market leader in analysis of the automation and software sectors, has shown that Modbus TCP/IP is the world-leading Ethernet industrial protocol in terms of units sold in 2004.

Modbus and Modbus TCP/IP are recognized by the IEC 61158 international standard as a fieldbus. They are also compliant with the "Chinese National Standard" managed by ITEI.

Interfacing CANopen with Modbus TCP/IP

CiA DSP 309-2 provides standardized organization of CANopen data to be carried on a Modbus TCP/IP Ethernet network. The specification reserves the Modbus 43/13 function code for this purpose. This function code is reserved exclusively for CANopen.

Characteristics of Modbus TCP/IP

Maximum size of data:

- Read: 125 words or registers
- Write: 100 words or registers

Modicon M340 automation platform

Ethernet TCP/IP network, Transparent Ready Ethernet TCP/IP communication services

Functions (continued)

I/O Scanning service

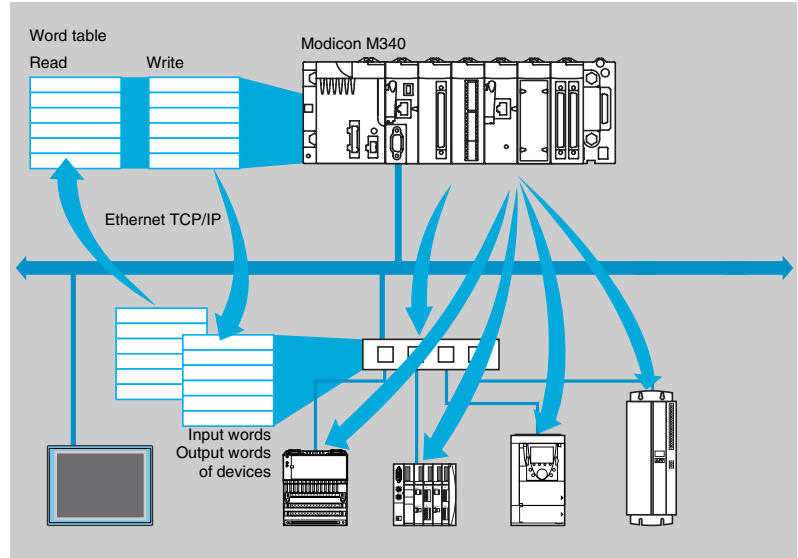

The I/O Scanning Service is used to manage the exchange of remote I/O states on the Ethernet network after simple configuration, without the need for any special programming.

I/O scanning is performed transparently by means of read/write requests according to the Modbus client/server protocol on the TCP/IP profile. This scanning principle via a standard protocol is used to communicate with any device supporting a Modbus server on TCP/IP.

This service allows you to define:

- A %MW word zone reserved for reading inputs.
- A %MW word zone reserved for writing outputs.
- Refresh periods independent of the PLC scan.

During operation, the module:

- Manages TCP/IP connections for each remote device.
- Scans devices and copies the I/O to the configured %MW word zone .
- Feeds back status words used to check that the service is working correctly from the PLC application.
- Applies pre-configured fallback values if a communication problem occurs

An offer of hardware and software products used to implement the I/O Scanning protocol on any type of device that can be connected to the Ethernet network is available (please consult the Modbus-IDA Web site: www.modbus-ida.org).

Characteristics

- Each Modicon M340 station can exchange a maximum of:
 - 100 write words
 - 125 read words
- Maximum size in the Modicon M340 PLC that manages the service (64 stations max.):
 - with **BMX NOE 0100** network module, 2 %MW Kwords as inputs and 2 %MW Kwords as outputs
 - with **BMX P34 2020/2030** processor, 512 %MW words as inputs and 512 %MW words as outputs

Diagnostics of the I/O Scanning service

There are 3 ways to perform diagnostics on the I/O Scanning service:

- Via the application program from a specific PLC data zone.
- From the setup software debug screen.
- From the PLC system diagnostic function displayed by means of an internet browser on a PC station.
- From the ConneXium diagnostic software **TCS EAZ 01P ●FE10**.
- From the standard SNMP manager software.

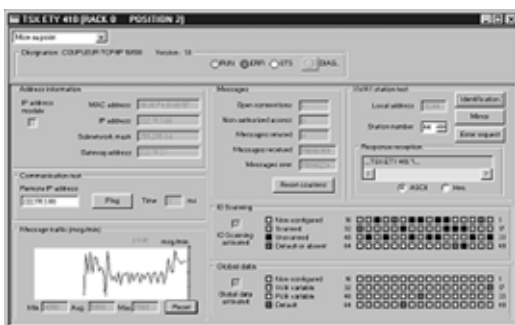

Modicon M340 automation platform

Ethernet TCP/IP network, Transparent Ready
Ethernet TCP/IP communication services

Functions (continued)

FDR (Faulty Device Replacement) service

The faulty device replacement service uses standard address management technologies (BOOTP, DHCP) and the TFTP (*Trivial File Transfer Protocol*) file management service, in the aim of simplifying maintenance of Ethernet products.

It is used to replace a faulty device with a new device with the guarantee that it will be detected, reconfigured and automatically rebooted by the system.

The main steps in replacement are:

- 1 A device using the FDR service malfunctions.
- 2 Another similar device is taken from the maintenance store, preconfigured with the Device name for the faulty device, then reinstalled on the network. Depending on the devices, addressing can be performed using spin buttons (for example, Advantys STB distributed I/O, **a** or Advantys OTB) or can be given via the keypad integrated in the device (for example Altivar variable speed drives).
- 3 The FDR server detects the new device, allocates it an IP address and transfers the configuration parameters to it.
- 4 The substituted device checks that all these parameters are indeed compatible with its own characteristics and switches to operational mode.

The FDR server can be:

- A Modicon M340 Ethernet network module, **BMX NOE 0100**
- A Modicon Premium processor with integrated Ethernet port, **TSX P57 ●●●●M**
- A Modicon Quantum processor with integrated Ethernet port, **140 CPU 651 50/60**
- A Modicon Premium Ethernet module, **TSX ETY 4103/5103**
- A Modicon Quantum PLC Ethernet module, **140 NOE 771 01/11**



"NIM" network module
for Advantys STB I/O

Modicon M340 automation platform

Ethernet TCP/IP network, Transparent Ready Ethernet TCP/IP communication services

Functions (continued)

Global Data service

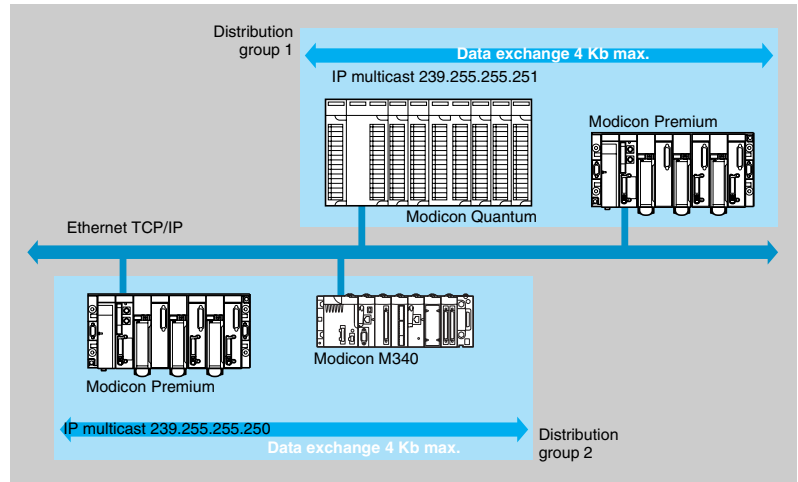

The Global Data service exchanges data in real time between stations belonging to the same distribution group. It is used to synchronize remote applications, or even to share a common database between a number of distributed applications. Exchanges are based on a producer/consumer type standard protocol, guaranteeing optimum performances with a minimum load on the network. This RTPS (*Real Time Publisher Subscriber*) protocol is promoted by Modbus-IDA (*Interface for Distributed Automation*), and is already a standard adopted by several manufacturers.

Characteristics

A maximum of 64 stations can participate in Global Data within a single distribution group.

Each station can:

- Publish 1 variable of 1024 bytes. The publication period can be configured from 1 to n processor master task (*Mast*) periods.
- Subscribe between 1 and 64 variables. The validity of each variable is controlled by status bits (*Health Status bits*) linked to a refresh timeout configurable between 50 ms and 1 s. Access to an element of the variable is not possible. The total size of subscribed variables amounts to 4 contiguous Kbytes.

To further optimize the performance of the Ethernet network, Global Data can be configured with the “multicast filtering” option which, combined with switches in the ConneXium range (see pages 3/26 to 3/33) distribute data only to Ethernet ports where there is a station subscribed to the Global Data service. If these switches are not used, Global Data is sent in “multicast” mode to all switch ports.

Global Data service diagnostics

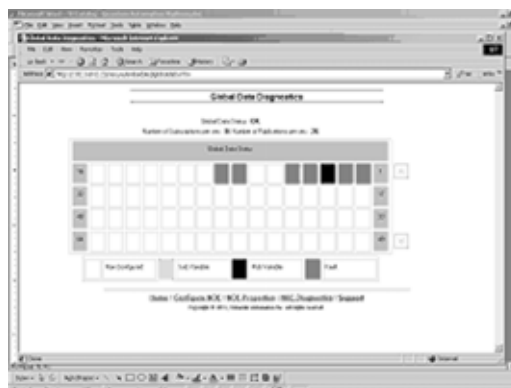

The diagnostic screens show the status of Global Data using a color code:

- Configured/not configured/faulty
- Published/subscribed

Modicon M340 automation platform

Ethernet TCP/IP network, Transparent Ready Ethernet TCP/IP communication services

Functions (continued)

SNMP network management service

From a network management station, the SNMP (*Simple Network Management Protocol*) protocol monitors and checks all components of the Ethernet architecture and thus ensures quick diagnostics in the event of a problem.

It is used to:

- Interrogate network components such as computer stations, routers, switches, bridges or terminal devices to display their status.
- Obtain statistics about the network on which devices are connected.

This network management software adheres to the conventional client/server model. However, to avoid confusion with other communication protocols that use this terminology, we talk instead about:

- ConneXview network diagnostics software, **TCS EAZ 01P ●FE10**.
- Network manager for the client application that operates on the computer station.
- SNMP agent for the network device server application

Transparent Ready devices can be managed by any SNMP network manager, including HP Openview and IBM Netview.

The SNMP (*Simple Network Management Protocol*) standard protocol is used for access to configuration and management objects that are contained in the device MIB (Management Information Base). These MIBs must comply with certain standards to be accessed by any commercially-available manager, but depending on the complexity of products, manufacturers can add certain objects to private databases.

The Transparent Ready private MIB presents management objects specific to the Telemecanique offer. These objects simplify the installation, setup and maintenance of Transparent Ready devices in an open environment using standard network management tools.

Transparent Ready devices support 2 levels of SNMP network management:

- The Standard MIB II interface: An initial level of network management is accessible via this interface. It enables the manager to identify the devices making up the architecture and retrieve general information on the configuration and operation of Ethernet TCP/IP interfaces.
- The Transparent Ready MIB interface: the management of Transparent Ready devices is improved via this interface. This MIB has a set of information enabling the network management system to supervise all the Transparent Ready services. The Transparent Ready MIB can be downloaded from the FTP server of any Transparent Ready Ethernet module in a PLC.



Automatic recognition of IP devices via the ConneXview diagnostic software for Ethernet industrial networks

Modicon M340 automation platform

Ethernet TCP/IP network, Transparent Ready
Performances

Selecting the communication architecture

When choosing an architecture, it is advisable to take account of the required performance as early as possible. To do this, the developer must:

- 1 Know exactly what he needs:
 - quantity and type of devices to be connected to one another
 - volume and type of exchanges
 - expected response times
 - environment
- 2 Compare his needs with the characteristics of the available offers, being aware that the actual performance level between any 2 points in an architecture is dependent on the weakest link in the chain, which may:
 - depend on the hardware
 - but also depends on the applications (size, architecture, operating system, machine power rating, etc) which are often only vaguely defined at this stage of the project.
- 3 Work out from this which is the most suitable architecture.

The purpose of the next few pages is to provide the main information and instructions needed to answer the second point. Given that the performance of an Ethernet architecture is linked to several parameters, these pages do not supply all the information needed to calculate the network performance. Their aim is to focus on the following main aspects:

- **Instructions for calculating the network load** so as to design an Ethernet network that meets the demands of the applications.
- **Application response time** to be obtained depending on the configuration used, see page 3/15 to 3/17.
- **Processing capacities of Modicon M340, Modicon Premium and Modicon Quantum platforms** used to select the processor and define the number of Ethernet connections required on the PLC depending on the application, see pages 3/18 and 3/19.

Calculating the network load

Introduction

When calculating the load on an Ethernet network, all the communication services of all the peripheral devices connected to the network need to be calculated. Because of the outstanding performance of the Ethernet network, the load is often less than the limits of the Ethernet network and does not greatly affect the application response time. This phenomenon is explained by the high speed of the Ethernet network: the network transaction time is 10% less than the application response time. In order to ensure a low network load and avoid large theoretical calculations, it is highly advisable to separate the collision domain so as to limit the network load, using only the switched network (tree, star or daisy-chain topology).

Modicon M340 automation platform

Ethernet TCP/IP network, Transparent Ready Performances

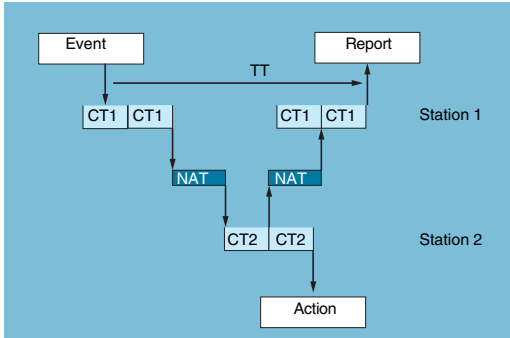

Application response time

Modbus (or Uni-TE) messaging service response time

Exchanges between the PLC processor and the Ethernet module are synchronous with the PLC scan time, just like the I/O exchanges. On occurrence of the event (an input set to state 1 for example), a message can only be sent after this input has been taken into account (start of the next cycle) and execution of the PLC program (Modicon M340, Modicon Premium or Modicon Quantum), are on average around 1.5 cycle times after occurrence of the event.

The network access time (NAT) appearing in the table below in ms, adds together the module transit time and the waiting time before the message can be sent on the network.

Processing Modbus TCP/IP message requests	Modicon M340		Modicon Premium		Modicon Quantum	
	BMX NOE 0100	BMX P34 2030 BMX P34 2040	TSX ETY 210 TSX ETY 110WS	TSX ETY 4103/5103 TSX WMY 100 TSX P57 10...57 50	140 NOE 771 01/111 140 CPU 113/311 ●● 140 CPU 434/534 1●	140 CPU 65 150/160 140 CPU 67 160
Network access time NAT	< 10 ms	< 10 ms	< 25 ms	< 10 ms	< 10 ms	< 10 ms

The transaction time TT integrates the delay between sending a message from a client station 1, its reception by the server station 2, processing the request, sending the response and it being taken into account by the station 1 (updating an output for example).

As shown in the above block diagram:

- The transaction time TT should be between:

$$2 \times CT1 + 2 \times NAT < TT < 4 \times CT1 + CT2 + 2 \times NAT$$

- The average duration TT_{av} is equivalent to:

$$TT_{av} = 3 \times CT1 + 0.5 \times CT2 + 2 \times NAT$$

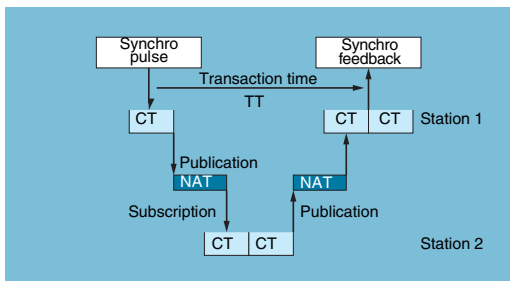

Global Data service response time

The transaction time TT integrates the delay between publication of a Global Data service by station 1, its reception and its processing by the remote station 2 and it being resent to the initial station 1:

For an exchanged variable:

- If $CT < 5$ ms,

transaction time:

$$TT = 5 \text{ to } 6 \times CT$$

- If $CT \geq 10$ ms,

transaction time:

$$TT = 3 \times CT$$

Modicon M340 automation platform

Ethernet TCP/IP network, Transparent Ready Performances

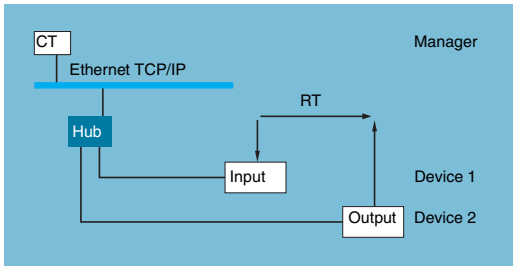

Application response time (continued)

I/O Scanning service response time

The response time RT includes the time between taking a remote input into account and updating the state of a remote output. It includes the processing time in the PLC.

This response time RT consists of the following parameters:

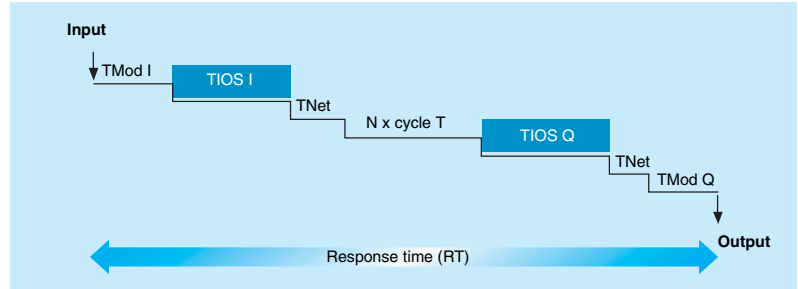

- TMod In and TMod Out: Response time of the read/written device, excluding the electrical transit time at the input/output (TMod depends on the device, usually between 1 and 8 ms)
- TIOS In and TIOS Out: Time between 2 read/write operations on the same device (0.3 ms x number of scanned devices), at least equivalent to the configured scan time
- As TIOS is executed in parallel with the PLC scan, it can be hidden with respect to the response time RT).
- Cycle T: PLC scan time.
- TNet : propagation time on the network (depends on the application, usually TNet = 0.05 ms at 10 Mbps and 0.005 ms at 100 Mbps).

The response time RT can be estimated with the following 3 formulas:

■ **RT_{min}**, minimum response time with TIOS hidden and 1 PLC scan:

$$RT_{min} = (TMod In + 0) \times TIOS In + (Tnet + N) \times cycle T + (0 \times TIOS Out) + Tnet + TMod Out$$

■ **RT_{typ.}**, typical response time with 0.5 TIOS hidden:

$$RT_{typ.} = TMod In + 0,5 \times TIOS In + (Tnet + N) \times Cycle T + (0,5 \times TIOS Out) + Tnet + TMod Out$$

■ **RT_{max}**, maximum response time with TIOS not hidden:

$$RT_{max} = TMod In + TIOS In + (Tnet + N) \times Cycle T + TIOS Out + Tnet + TMod Out$$

Modicon M340 automation platform

Ethernet TCP/IP network, Transparent Ready Performances

Application response time (continued)

I/O Scanning service response time (continued)

Below are the TMod In and TMod Out response times:

Type of distributed I/O	Response time	Min.	Typical	Max.
Momentum 170 ENT 110 02	TMod In	1 ms	1 ms	1 ms
	TMod Out	5 ms	5 ms	5 ms
Momentum 170 ENT 110 01	TMod In or TMod Out	4 ms	6 ms	8 ms
Advantys STB STB NIP 2212	TMod In or TMod Out	2 ms	3 ms	4 ms

Below are the TIOS In/TIOS Out times measured between 2 scan cycles (Ethernet network with switches)

Time (ms)

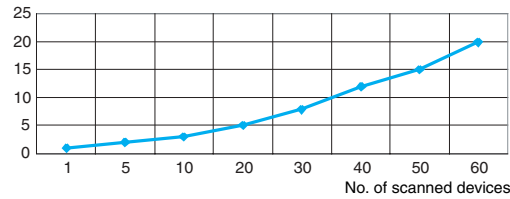

Below is the number of processor cycles N:

Number of processor cycles N	Min.	Typical	Max.
Modicon M340 platform with BMX NOE 0100 module	2	2.5	3
Premium platform with TSX ETY 4103/5103 modules			
Quantum platform with 140 NOE 771 01/771 11 modules			
Modicon M340 BMX P34 2030/2040 processors	1	1	2
Premium processors TSX P57 26/3634M, TSX P57 26/2823M and TSX P57 36/4823AM			
Premium processors TSX P57 46/5634M			
Quantum processors 140 CPU 651 50/60			

Modicon M340 automation platform

Ethernet TCP/IP network, Transparent Ready Performances

Processing capacities of Modicon platforms

Processing capacity

Use the table below to compare for each station, the total number of messages received on the Modbus (or Uni-TE) messaging service if used (value R1, R2 or Ri) with the station processor capacity.

Processing Modbus requests for each PLC scan

Modicon M340, Modicon Premium/Atrium platforms	Messages received
Communication using EFs or EFBs (PL7 or Unity Pro)	
Total messages received by the PLC from all the communication modules (1)	TSX 57 10 4 messages/cycle
	BMX P34 20/TSX 57 20 8 messages/cycle
	TSX 57 30 12 messages/cycle
	TSX 57 40 16 messages/cycle
	TSX 57 50 (2) 16/20 messages/cycle

Modicon Quantum platform	Limitations of the integrated port		Limitations of the communication modules		Ethernet modules per PLC
	All types of communication request	Additional read/write 4x registers	All types of communication request	Additional read/write 4x registers	
140 CPU 113 (3)	–	–	1 message/cycle	4 messages/cycle	max. 2
140 CPU 311	–	–	1 message/cycle	4 messages/cycle	max. 2
140 CPU 434/534	–	–	4 messages/cycle	8 messages/cycle	max. 6
140 CPU 651	16 messages/cycle	16 messages/cycle	4 messages/cycle	8 messages/cycle	max. 6

messages/cycle: number of messages received per cycle from the PLC master task (typical cycle of 50 to 100 ms)

Example:

Quantum 140 CPU 434 12● processor with 4 Ethernet 140 NOE 771 ●1 modules:
- 20 messages/cycle for all types of communication request, and
- 32 messages/cycle for the read/write 4x registers

Ethernet transaction processing capacity

Compare, for each station, the total number of messages received Σ [values Ri, Rj] and the total number of messages sent Σ [values Ei, Ej] (for example, for station N) with the Ethernet transaction processing capacity indicated below.

Use the elements below for the Ethernet connection per PLC, rather than the number of transactions required by the application.

Ethernet transaction processing capacity	Modicon M340 BMX		Modicon Premium TSX			Modicon Quantum140	
	NOE 0100	P34 2030 P34 2040	ETY 210 ETY 110WS	ETY 4103/5103 WMY 100 (4) P57 10/20/30/40	P57 50	NOE 771 01/11 NWM 100 00 (4)	CPU 65 150/160 CPU 67 160
Modbus messaging	450 transactions/s	200 transactions/s	60 transactions/s	450 transactions/s	500 transactions/s	350 transactions/s	350 transactions/s
I/O Scanning service	2,000 transactions/s	Service not available	Service not available	2,000 transactions/s	2,000 transactions/s	2,000 transactions/s	2,000 transactions/s
Publication of Global Data	800 transactions/s			800 transactions/s	800 transactions/s	800 transactions/s	800 transactions/s

(1) A temporary overload, due for example to an adjustment terminal or the temporary connection of an Internet browser, on which a few PLC scans are permitted.

(2) Only with Unity Pro software.

(3) Only with Concept/ProWORX software.

(4) Module not featuring I/O Scanning and Global Data services (TSX WMY 100 and 140 NWM 100 00).

Modicon M340 automation platform

Ethernet TCP/IP network, Transparent Ready Performances

Processing capacities of Modicon platforms (continued)

Maximum number of simultaneous TCP/IP connections

The maximum number of simultaneous TCP/IP connections depends on the platform as well as the type of connection to the Ethernet network:

- The 10/100BASE-TX port in network modules.
- The 10/100BASE-TX port integrated in processors.

Number of simultaneous TCP/IP connections	Modicon M340		Modicon Premium			Modicon Quantum	
	BMX NOE 0100	BMX P34 2030 BMX P34 2040	TSX ETY 210 TSX ETY 110WS	TSX ETY 4103/5103 TSX WMY 100 TSX P57 10...57 50	140 NOE 771 01/11 140 CPU 113/311 ●● 140 CPU 434/534 14B	140 CPU 65 150 140 CPU 65 160	
Client	16	16	32	16 (1)	16 (1)	16 (1)	
Server	16	16		64 (1)	64 (1)	64 (1)	

(1) With 64 simultaneous TCP/IP connections maximum (clients and servers).



Managing the passband of Ethernet TCP/IP modules

The passband management service indicates the load level of the Ethernet network module. This allows the user to monitor any drift and anticipate any problems.

The Ethernet module load is indicated in 3 ways:

- Expected load in the Unity Pro/PL7 configuration screen.
- Actual load in the Unity Pro/PL7 diagnostics/debug screen, as well as in the diagnostics pages via the Web. It is displayed in the form of a bar chart animated in real time.
- In the SNMP interface for access by the SNMP network manager.



The passband is indicated as a percentage for each of the following services:

- Modbus (and Uni-TE) messaging
- I/O Scanning
- Global Data
- Other

Modicon M340 automation platform

Ethernet TCP/IP network, Transparent Ready Processor solutions with integrated port or module



Ethernet port integrated in the BMX P34 2030/2040

or



Ethernet module BMX NOE 0100

Ethernet solutions with the Modicon M340 platform

The M340 PLC has 2 types of connection to the Ethernet network:

- The 10/100BASE-TX port integrated in **BMX P34 2030/2040** Performance processors, which also process the application, exchanges with other modules supported by the rack and other communication ports (CANopen bus or Modbus serial link).
- The 10/100BASE-TX port in the **BMX NOE 0100** module on which, unlike the Performance processor, all the resources are allocated to Ethernet TCP/IP communication.

These fundamentally different hardware characteristics result in equally different capacities in terms of services and performance:

- The integrated port is a low-cost way of satisfying applications that are not too demanding in terms of communication (less than 500 useful messages/s) in environments little affected by interference.
- Where there are a large number of exchanges, or networks are heavily polluted, use of a dedicated module is unavoidable.

In the detailed information, in order to choose the most suitable solution for a given application

two criteria should be analyzed:

- The required capacity in terms of service level
- The required capacity in terms of performance

Level of service

Some services are only supported by the **BMX NOE 0100** module, whereas others are only (or partially) supported by the integrated port of **BMX P34 2030/2040** processors.

See Characteristics section on pages 3/22 and 3/23.

Performance

Two types of communication should be considered:

- **“Application”** or **“useful” exchanges** affecting the PLC, ie. incoming/outgoing Modbus TCP/IP messages, I/O Scanning or Global Data service exchanges, HTTP or FTP requests addressed to the PLC server, etc.

Typically:

- The **BMX NOE 0100** module has a processing capacity of around **2000 messages/s** (total incoming/outgoing).
- The integrated Ethernet port only processes **500 messages/s**.

- **“Unexpected” exchanges** that may result from a programming error or an external event. This is traffic that has nothing to do with normal operation, not explicitly destined for the PLC but which, if it occurs, risks generating a load on the Ethernet port. Two examples:

- A hardware problem on a switch, a routing error or a computer virus on a PC, cause an avalanche of unicast frames to be sent to the PLC IP address.
- The PLC has unintentionally been included in a group where too many Global Data variables are published for the Ethernet port processing capacity.

With the **BMX NOE 0100** module, this “unexpected” traffic must never limit the processing capacity of the “application” communication.

On the integrated port of **BMX P34 2030/2040** processors, this “unexpected” traffic can cause problems. Use of the integrated Ethernet port should therefore be reserved for architectures where the ambient traffic is mastered. If this ambient traffic degenerates, the impact on the processor and therefore on program execution may become significant and Ethernet frames may be lost.

Modicon M340 automation platform

Ethernet TCP/IP network, Transparent Ready Processor solutions with integrated port or module

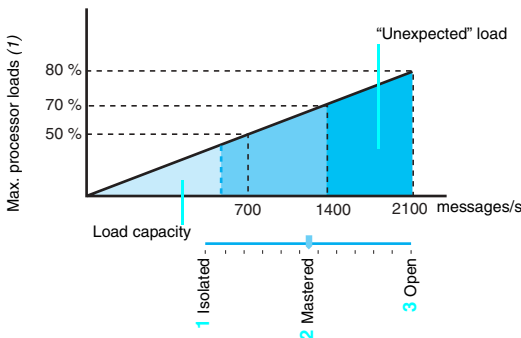

Setting the passband level in the processor integrated Ethernet ports

Bandwidth of the integrated port of BMX P34 processors

The figure opposite illustrates the risk and the ways of overcoming “unexpected” traffic:

- 1 By default, the Ethernet port is configured with the bandwidth in “isolated” mode option, meaning that the **BMX P34 2030/2040** processor is connected on an isolated network or one on which exchanges are fully mastered. The user is assured that the total traffic, including the unexpected, will never exceed **700 messages/s**. This is the case for example of an isolated machine hard-wired on Ethernet and using Modbus or I/O Scanning services. In this case, the CPU load dedicated to Ethernet is guaranteed never to exceed 50%.
- 2 If the environment is more open, with the network connected to another Ethernet segment, the fact of setting the bandwidth to “mastered” mode will enable the **BMX P34 2030/2040** processor to absorb this additional traffic, with a maximum of **1400 messages/s**.
 ⚠ Up to 70% of the processor resources can be used in the event of intense activity, with the corresponding impact on the application cycle time.
- 3 Finally, if the machine network is linked to the office computer network or the Internet, it is possible that the traffic may become very heavy at intervals. If this is a proven risk, the bandwidth must be set to maximum, corresponding to “open” mode. Exchange peaks, up to **2100 messages/s**, can then be absorbed, but at times the processor load may then be as much as 80%. This may still be suitable for building or infrastructure type applications where the realtime aspect is not critical. On this type of application, the use of a switch or VLAN technologies will nonetheless make it possible to reduce the loading on the Ethernet link considerably.

Note: Note that in the 3 cases described above, the useful traffic of 500 messages/s is guaranteed. In addition, the diagnostic functions integrated in the product allow the user to measure the loading on the processor and its integrated Ethernet port in real time and therefore to adjust the bandwidth setting during the application debug phase.

If the installation characteristics are not the same as the 3 previous configurations, the **BMX NOE 0100** module can be used to connect a Modicon M340 platform to a network that is potentially very polluted and/or requiring a very large number of application exchanges, more than 500 messages/s.

Summary

The graph below summarizes the load levels as a function of the traffic expressed in messages/s according to the type of connection to the Ethernet network: processor integrated port or Ethernet network module.

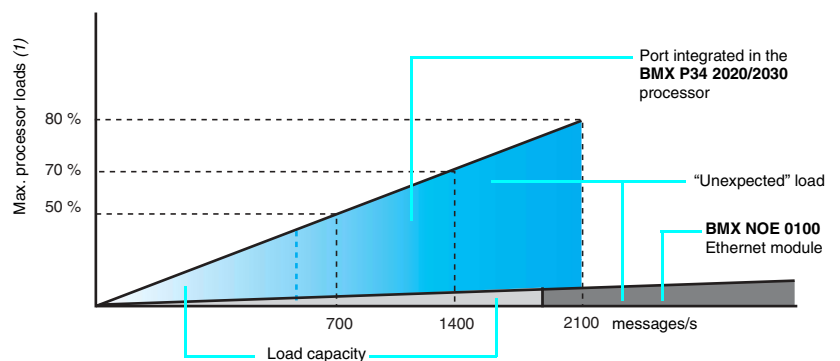

(1) With a processor load > 80%, risk of losing messages.

Modicon M340 automation platform

Processors with integrated Ethernet port

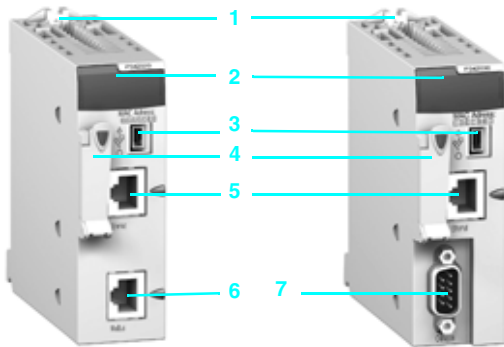

Description

BMX P34 2020 and **BMX P34 2030** Modicon M340 processors with integrated Ethernet port have the following on the front panel:

- 1 Safety screw for locking the module in its slot (marked 0) in the rack
- 2 A display unit including at minimum 3 LEDs relating to the Ethernet port:
 - ETH ACT LED (green): Activity on the Ethernet TCP/IP network
 - ETH STS LED (green): Ethernet TCP/IP network status
 - ETH 100 LED (red): Data rate on the Ethernet TCP/IP network (10 or 100 Mbps)
- 3 A mini B USB connector for a programming terminal (or Magelis XBT GT operator interface) (1)
- 4 A slot equipped with its Flash memory card for saving the application and activating the standard Web server, Transparent Ready class B10 .
- 5 An RJ45 connector for connection to the 10BASE-T/100BASE-TX Ethernet TCP/IP network

Also included, depending on the model:

- 6 **BMX P 34 2020** processor: An RJ45 connector for the Modbus serial link or character mode link (RS 232C/RS 485, 2-wire, non-isolated)
- 7 **BMX P 34 2030** processor: A 9-way SUB-D connector for the master CANopen machine and installation bus

On the back panel: 2 rotary switches for assigning the IP address in one of 3 modes:

- Address set by the position of the two switches
- Address set by the application parameters
- Address set by the Ethernet TCP/IP BOOTP server

Characteristics

Module type	Unity Pro software	BMX P34 2020	BMX P34 2030
Transparent Class		B10	
Ready services	Standard Web server	Rack Viewer access to the product description and status and to the PLC diagnostics Data Editor access to the configuration functions and PLC variables	
	Standard Ethernet TCP/IP communication service	Modbus TCP messaging (read/write data words)	
	Ethernet TCP/IP advanced communication services	I/O Scanning	–
		Global Data	–
		FDR Client	Automatic assignment of IP address and network parameters
		SMTP E-mail notification	–
		SNMP network administrator	Yes
		Bandwidth management	Yes
Structure	Physical interface	10BASE-T/100BASE-TX (RJ45)	
	Data rate	10/100 Mbps with automatic recognition	
	Medium	Twisted pair	
Modicon M340 processor	No. of discrete I/O	1024	
	No. of analog I/O	256	
	No. of application-specific channels	36	
	Max. no. of Ethernet TCP/IP connections	2 (integrated port and BMX NOE 0100 network module)	
	Other integrated communication ports	Modbus serial link or character mode	CANopen bus
	Operating temperature	0...+ 60 °C	
	Relative humidity	10...95% non condensing during operation	
	Degree of protection	IP 20	
	Power supply	Via the power supply of the rack supporting the processor	
	Conformity to standards	IEC/EN 61131-2, UL 508, CSA 22.2 n°142, CSA 22.2 n°213 Class 1 Division 2 , CÉ	
	LED indicators	Activity on the Ethernet TCP/IP network (ETH ACT, green) Status of the Ethernet TCP/IP network (ETH STS, green) Data rate on the 10 or 100 Mbps Ethernet TCP/IP network, (ETH 100, red) 4 LEDs specific to processor operation (RUN, ERR, I/O, CARD ERR) 1 or 2 LEDs specific to the other communication ports (SER COM or CAN RUN and CAN ERR) (2)	

References



BMX P34 2020

BMX P34 2030

Description	I/O capacity	Memory capacity	Other integrated communication ports	Reference	Weight kg
Processors with integrated Ethernet link	1024 discrete I/O 256 analog I/O	36 app-sp. channels	Modbus serial link or character mode CANopen bus	BMX P34 2020 BMX P34 2030	–
Class B10	4096 Kb integrated				

(1) The Magelis XBT GT graphic terminal requires Vijeo Designer configuration software version 4.5. Available 1st quarter 2007.

(2) SER COM for serial link or CAN RUN and CAN ERR for CANopen bus.

Modicon M340 automation platform

Ethernet network module

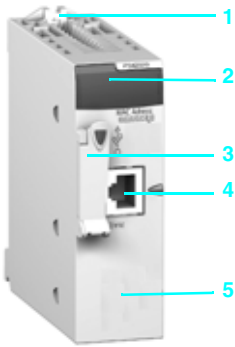

Presentation

The **BMX NOE 0100** module is a standard module occupying a single slot in the rack of the Modicon M340 platform equipped with a Standard processor or associated Performance processor (maximum of 1 module per configuration). Depending on the memory card it is equipped with, the Web server is Transparent Ready class B30 or C30

Description

The **BMX NOE 0100** module has the following on the front panel:

- 1 Safety screw for locking the module in its slot (marked 0) in the rack
 - 2 A display unit consisting of 6 LEDs, including 3 relating to the Ethernet port:
 - ETH ACT LED (green): Activity on the Ethernet TCP/IP network
 - ETH STS LED (green): Ethernet TCP/IP network status
 - ETH 100 LED (red): Data rate on the Ethernet TCP/IP network (10 or 100 Mbps)
 - 3 A slot equipped with its Flash memory card for activating the standard Web server, Transparent Ready class B30. This card can be replaced by the **BMX RWS C016M** card, Transparent Ready class C30
 - 4 An RJ45 connector for connection to the 10BASE-T/100BASE-TX Ethernet TCP/IP network
 - 5 A pencil-point RESET pushbutton for a cold restart of the module
- On the back panel: 2 rotary switches for assigning the IP address in one of 3 modes:
- Address set by the position of the two switches
 - Address set by the application parameters
 - 6 Address set by the Ethernet TCP/IP network BOOTP server

3

3.

Characteristics

Module type	Unity Pro software	BMX NOE 0100	BMX NOE 0100 + BMX RWS C016M
Transparent Class		B30	C30
Ready services	Standard Web server	Rack Viewer access to the product description and status and to the PLC diagnostics Data Editor access to the configuration functions and PLC variables	
	Configurable Web server	Yes	Yes
	User Web pages (available size)	–	Yes (16 Mb)
	Standard Ethernet TCP/IP communication service	Modbus TCP messaging (read/write data words)	
Ethernet TCP/IP advanced communication services	I/O Scanning	Yes	
	Global Data	Yes	
	FDR server	Automatic assignment of IP address and network parameters	
	SMTP E-mail notification	–	
	SNMP network administrator	Yes	
	Bandwidth management	Yes	
Structure	Physical interface	10BASE-T/100BASE-TX (RJ45)	
	Data rate	10/100 Mbps with automatic recognition	
	Medium	Twisted pair	
Network module	Operating temperature	0...+ 60 °C	
	Relative humidity	10...95% non condensing during operation	
	Degree of protection	IP 20	
	Power supply	Via the power supply of the rack supporting the processor	
	Conformity to standards	IEC/EN 61131-2, UL 508, CSA 22.2 n°142, CSA 22.2 n°213 Class 1 Division 2 , CÉ	
	LED indicators	Activity on the Ethernet TCP/IP network (ETH ACT, green) State of the Ethernet TCP/IP network (ETH STS, green) Data rate on the 10 or 100 Mbps Ethernet TCP/IP network, (ETH 100, red) 3 LEDs specific to module operation (RUN, ERR, CARD ERR)	

References



Description	Data rate	Transparent Ready class	Reference	Weight kg
Ethernet TCP/IP network module	10/100 Mbps	B30	BMX NOE 0100	–
Memory cards	(1)	C30	BMX RWS C016M	–
	(2)	B30	BMX RWS B000M	–

(1) Memory card to be ordered separately, replace the **BMX RWS B000M** memory card supplied as standard with the **BMX NOE 0100** module.
(2) Card as spare part, supplied as standard with the **BMX NOE 0100** module.

Modicon M340 automation platform

Réseau Ethernet TCP/IP, Transparent Ready
Cabling system: ConneXium hub

Presentation

Hubs (*concentrators*) are used for transmitting signals between several media (ports). Hubs are “plug and play” devices that do not need any configuration. The use of hubs makes it possible to create the following topologies:

- Star topology using hubs
- Tree topology using hubs

Consult our catalogue “Ethernet TCP/IP and Web technologies, Transparent Ready”.

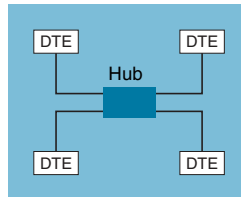

Star topology

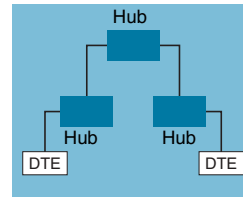

Tree topology

Characteristics and reference

Transparent



Hubs			
Interfaces	Copper cable ports	Number and type	4 x 10BASE-T ports
		Shielded connectors	RJ45
		Medium	Shielded twisted pair, category CAT 5E
		Total length of pair	100 m
	Fiber optic ports	Number and type	–
Topology	Number of cascaded hubs		max. 4
	Number of hubs in a ring		–
Redundancy			P1 and P2 redundant power supplies
Power supply	Voltage		24 V (18...32) $\overline{=}$, safety extra low voltage (SELV)
	Power consumption		80 mA (130 max. at 24 V $\overline{=}$)
	Removable connector		5-way
Operating temperature			0...+ 60 °C
Relative humidity			10...95% non condensing
Degree of protection			IP 30
Dimensions	W x H x D		40 x 125 x 80 mm
Mounting			On symmetrical DIN rail, 35 mm wide
Weight			0.530 kg
Conformity to standards			cUL 60950, UL 508 and CSA 142, UL 1604 and CSA 213 Class 1 Division 2, C€, GL FM 3810, FM 3611 Class 1 Division 2
LED indicators			Power supply, activity, link
Alarm relay			Power supply fault, Ethernet network fault or communication port fault (1 A max. volt-free contact at 24 V $\overline{=}$)
Reference			499 NEH 104 10

Modicon M340 automation platform

Réseau Ethernet TCP/IP, Transparent Ready
Cabling system: ConneXium transceivers

Presentation

The use of ConneXium transceivers makes it possible to perform the following:

- Creation of linear fiber optic bus topologies, for products with twisted pair cable Ethernet connection.
- Interfacing products with twisted pair cable Ethernet connection with a fiber optic cable.

Transceivers are “plug and play” devices that do not need any configuration. Consult our catalogue “Ethernet TCP/IP and Web technologies, Transparent Ready”.

ConneXium transceivers provide fiber optic connections for transmission in areas subject to interference (high levels of electromagnetic interference) and for long distance communications.

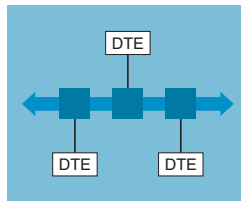

Linear topology on optical fiber

Characteristics and reference

Transparent Ready



Transceivers			
Interfaces	Copper cable ports	Number and type	1 x 100BASE-TX port
		Shielded connectors	
		Medium	Shielded twisted pair, category CAT 5E
	Fiber optic ports	Total length of pair	100 m
		Number and type	1 x 100BASE-FX port
		Connectors	SC
		Medium	Multimode optical fiber
		Length of optical fiber	
		50/125 µm fiber	3000 m (1)
		62.2/125 µm fiber	3000 m (1)
Attenuation analysis			
50/125 µm fiber	8 dB:		
62.2/125 µm fiber	11 dB:		
Redundancy		P1 and P2 redundant power supplies	
Power supply	Voltage	24 V (18...32) ---, safety extra low voltage (SELV)	
	Power consumption	160 mA (190 max. at 24 V ---)	
	Removable connector	5-way	
Operating temperature		0...+ 60 °C	
Relative humidity		10...95% non condensing	
Degree of protection		IP 20	
Dimensions	W x H x D	47 x 135 x 111 mm	
Mounting		On symmetrical DIN rail, 35 mm wide	
Weight		0.230 kg	
Conformity to standards		cUL 60950, UL 508 and CSA 142, UL 1604 and CSA 213 Class 1 Division 2, C, GL	
LED indicators		P1 and P2 power supplies, Ethernet link/port status	
Alarm relay		Power supply fault, Ethernet network fault or communication port fault (1 A max. volt-free contact at 24 V ---)	
Reference		499 NTR 10 100	

(1) Length dependent on the attenuation analysis and attenuation of the optical fiber (typical value: 2000 m).

Modicon M340 automation platform

Réseau Ethernet TCP/IP, Transparent Ready
Cabling system: ConneXium unmanaged switches

Presentation

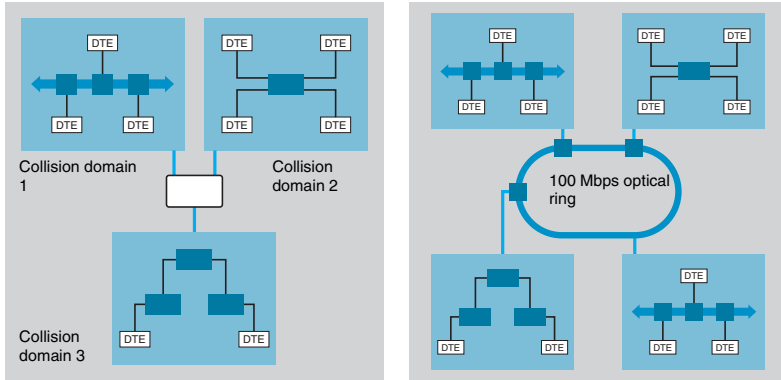

Switches are used to increase the limits of architectures based on hubs or transceivers, by separating collision domains.

Higher layer communication is provided between the ports, and collisions at link layer are not propagated (filtering). They therefore improve performance by better allocation of the pass band due to the reduction of collisions and the network load.

Certain Connexium switch models also enable redundant architectures to be created on twisted pair copper ring or fiber optic.

Switches are “plug & play” devices that do not need any configuration. They can also be managed remotely via the SNMP or HTTP protocols for monitoring and diagnostics purposes.

Consult our catalogue “Ethernet TCP/IP and Web technologies, Transparent Ready”.

Characteristics and references: twisted pair

Transparent Ready



Switches			Optimized, copper twisted pair, unmanaged	Copper twisted pair, unmanaged
Interfaces	Copper cable ports	Number and type	5 x 10BASE-T/100BASE-TX ports	8 10BASE-T/100BASE-TX ports
		Shielded connectors	RJ45	
		Medium	Shielded twisted pair, category CAT 5E	
		Total length of pair	100 m	
	Fiber optic ports	Number and type	-	
		Connectors	-	
		Medium	-	
		Length of optical fiber	-	
		50/125 µm fiber	-	
		62.2/125 µm fiber	-	
Attenuation analysis	50/125 µm fiber	-		
	62.2/125 µm fiber	-		
	9/125 µm fiber	-		
Topology	Number of switches	Cascaded	Unlimited	
		Redundant in a ring	-	
Redundancy			-	P1 and P2 redundant power supplies
Power supply	Voltage		24 V $\overline{\text{---}}$ (19.2...30)	24 V $\overline{\text{---}}$ (18...32) safety extra low voltage (SELV)
	Power consumption	mA max.	120	125 (290 max.)
	Removable connector		3-way	5-way
Operating temperature			0...+ 60 °C	
Relative humidity			10...95% non condensing	
Degree of protection			IP 20	
Dimensions		W x H x D	75.2 x 143 x 43 mm	47 x 135 x 111 mm
Mounting			On symmetrical DIN rail, 35 mm wide	
Weight			0.190 kg	0.230 kg
Conformity to standards			UL 508, CSA 1010, EN 61131-2	cUL 60950, UL 508 and CSA 142, UL 1604 and CSA 213 Class 1 Division 2, C, E, GL
LED indicators			Power supply, link status, data rate	P1 and P2 power supplies, Ethernet link/port status
Alarm relay			-	Power supply fault, Ethernet network fault or communication port fault (1 A max. volt-free contact at 24 V $\overline{\text{---}}$)
Reference			499 NES 251 00	499 NES 181 00

Modicon M340 automation platform

Réseau Ethernet TCP/IP, Transparent Ready
Cabling system: ConneXium unmanaged switches

Characteristics and references: 5 ports, twisted pair and fiber optic



Switches			Copper twisted pair and fiber optic, unmanaged			
Interfaces	Copper cable ports	Number and type	4 x 10BASE-T/ 100BASE-TX ports	3 x 10BASE-T/ 100BASE-TX ports	4 x 10BASE-T/ 100BASE-TX ports	3 x 10BASE-T/ 100BASE-TX ports
		Shielded connectors	RJ45			
		Medium	Shielded twisted pair, category CAT 5E			
		Total length of pair	100 m			
	Fiber optic ports	Number and type	1 x 100BASE-FX port	2 x 100BASE-FX ports	1 x 100BASE-FX port	2 x 100BASE-FX ports
		Connectors	SC			
		Medium	Multimode optical fiber		Single mode optical fiber	
		Length of optical fiber				
		50/125 µm fiber	5,000 m (1)		-	
		62.2/125 µm fiber	4,000 m (1)		-	
Attenuation analysis	9/125 µm fiber	-		32,500 m (2)		
	50/125 µm fiber	8 dB		-		
	62.2/125 µm fiber	11 dB		-		
	9/125 µm fiber	-		16 dB		
Topology	Number of switches	Cascaded	Unlimited			
		Redundant in a ring	-			
Redundancy			P1 and P2 redundant power supplies			
Power supply	Voltage	24 V $\bar{\text{---}}$ (18...32), safety extra low voltage (SELV)				
	Power consumption	mA max.	200	240	200	240
	Removable connector	5-way				
Operating temperature			-40...+70 °C			
Relative humidity			10...95% non condensing			
Degree of protection			IP 20			
Dimensions	W x H x D		47 x 135 x 111 mm			
Mounting			On symmetrical DIN rail, 35 mm wide			
Weight			0.330 kg	0.335 kg	0.330 kg	0.335 kg
Conformity to standards			cUL 60950, cUL 508 and CSA 142, UL 1604 and CSA 213 Class 1 Division 2, CE, GL			
LED indicators			P1 and P2 power supplies, Ethernet link status, transmission activity			
Alarm relay			Activity, power supply fault, Ethernet network fault or communication port fault (1 A max. volt-free contact at 24 V $\bar{\text{---}}$)			
Reference			499 NMS 251 01	499 NMS 251 02	499 NSS 251 01	499 NSS 251 02

(1) Length dependent on the attenuation analysis and attenuation of the fiber optic (typical value: 2,000 m).

(2) Length dependent on the attenuation analysis and attenuation of the fiber optic (typical value: 15,000 m).

Modicon M340 automation platform

Réseau Ethernet TCP/IP, Transparent Ready
Cabling system: ConneXium managed switches

Characteristics and references: 4 ports, twisted pair and fiber optic

Transparent Ready



Switches			Copper twisted pair and fiber optic, managed			
Interfaces	Copper cable ports	Number and type	3 x 10/100BASE-TX ports	2 x 10/100BASE-TX ports	3 x 10/100BASE-TX ports	2 x 10/100BASE-TX ports
		Shielded connectors	RJ45			
		Medium	Shielded twisted pair, category CAT 5E			
	Fiber optic ports	Total length of pair	100 m			
		Number and type	1 x 100BASE-FX port	2 x 100BASE-FX ports	1 x 100BASE-FX port	2 x 100BASE-FX ports
		Connectors	Duplex SC			
		Medium	Multimode optical fiber		Single mode optical fiber	
		Length of optical fiber				
		50/125 µm fiber	5,000 m (1)			–
		62.2/125 µm fiber	4,000 m (1)			–
9/125 µm fiber	–			32,500 m (2)		
Ethernet services	Attenuation analysis					
	50/125 µm fiber	8 dB			–	
	62.2/125 µm fiber	11 dB			–	
Ethernet services	9/125 µm fiber				16 db	
			FDR, SMTP V3, SNMP client, multicast filtering for optimization of the Global Data protocol, configuration via Web access VLAN, IGMP Snooping, RSTP (<i>Rapid Scanning Tree Protocol</i>), priority port, data stream control, secure port			
Topology	Number of switches	Cascaded	Unlimited			
		Redundant in a ring	max. 50			
Redundancy		Redundant power supplies, redundant single ring, ring coupling				
Power supply	Voltage	Operation	9.6...60 V $\overline{=}$ /18...30 V \sim , safety extra low voltage (SELV)			
	Power consumption		6.5 W	7.3 W	6.5 W	7.3 W
	Removable connector		6-way			
Operating temperature		0...+ 60 °C				
Relative humidity		10...90% non condensing				
Degree of protection		IP 20				
Dimensions		W x H x D	47 x 131 x 111 mm			
Mounting		On symmetrical DIN rail, 35 mm wide				
Weight		0.400 kg				
Conformity to standards		IEC 61131-2, IEC 61850-3, UL 508, UL 1604 Class 1 Division 2, CSA C22.2 14 (cUL), CSA C22.2 213 Class 1 Division 2 (cUL), C€, GL				
LED indicators		Power supply status, alarm relay status, active redundancy, redundancy management, copper port status and copper port activity				
Alarm relay		Power supply fault, Ethernet network fault, communication port fault, redundancy fault (1 A max. volt-free contact at 24 V $\overline{=}$)				
Reference		TCS ESM 043F1CU0	TCS ESM 043F2CU0	TCS ESM 043F1CS0	TCS ESM 043F2CS0	

(1) Length dependent on the attenuation analysis and attenuation of the fiber optic (typical value: 2,000 m).

(2) Length dependent on the attenuation analysis and attenuation of the fiber optic (typical value: 15,000 m).

Modicon M340 automation platform

Réseau Ethernet TCP/IP, Transparent Ready
Cabling system: ConneXium managed switches

Characteristics and references: 4 and 8 ports, twisted pair



Switches			Copper twisted pair, managed		
Interfaces	Copper cable ports	Number and type	4 x 10/100BASE-TX ports	8 x 10/100BASE-TX ports	
		Shielded connectors	RJ45		
		Medium	Shielded twisted pair, category CAT 5E		
		Total length of pair	100 m		
	Fiber optic ports	Number and type	-		
		Connectors	-		
		Medium	-		
		Length of optical fiber	-		
		50/125 µm fiber	-		
		62.2/125 µm fiber	-		
		9/125 µm fiber	-		
	Ethernet services	Attenuation analysis		-	
		50/125 µm fiber		-	
62.2/125 µm fiber		-			
9/125 µm fiber		-			
Ethernet services			FDR, SMTP V3, SNMP client, multicast filtering for optimization of the Global Data protocol, configuration via Web access VLAN, IGMP Snooping, RSTP (<i>Rapid Scanning Tree Protocol</i>), priority port, data stream control, secure port		
Topology	Number of switches	Cascaded	Unlimited		
		Redundant in a ring	max. 50		
Redundancy			Redundant power supplies, redundant single ring, ring coupling		
Power supply	Voltage	Operation	9.6...60 V $\overline{\text{---}}$ /18...30 V \sim , safety extra low voltage (SELV)		
	Power consumption		5.3 W	5.3 W	
	Removable connector		6-way		
Operating temperature			0...+ 60 °C		
Relative humidity			10...90% non condensing		
Degree of protection			IP 20		
Dimensions		W x H x D	47 x 131 x 111 mm	74 x 131 x 111 mm	
Mounting			On symmetrical DIN rail, 35 mm wide		
Weight			0.400 kg	0.410 kg	
Conformity to standards			IEC 61131-2, IEC 61850-3, UL 508, UL 1604 Class 1 Division 2, CSA C22.2 14 (cUL), CSA C22.2 213 Class 1 Division 2 (cUL), C€, GL		
LED indicators			Power supply status, alarm relay status, active redundancy, redundancy management, copper port status and copper port activity	Power supply status, alarm relay status, active redundancy, redundancy management, fiber port status and fiber port activity	
Alarm relay			Power supply fault, Ethernet network fault or communication port fault (1 A max. volt-free contact at 24 V $\overline{\text{---}}$)		
Reference			TCS ESM 043F23F0	TCS ESM 083F23F0	

3
3.

Modicon M340 automation platform

Réseau Ethernet TCP/IP, Transparent Ready
Cabling system: ConneXium managed switches

Characteristics and references: 8 ports, twisted pair and fiber optic

Transparent Ready



Switches			Copper twisted pair and fiber optic, managed					
Interfaces	Copper cable ports	Number and type	7 x 10/100BASE-TX ports	6 x 10/100BASE-TX ports	7 x 10/100BASE-TX ports	6 x 10/100BASE-T ports		
		Shielded connectors	RJ45					
		Medium	Shielded twisted pair, category CAT 5E					
		Total length of pair	100 m					
	Fiber optic ports	Number and type	1 x 100BASE-FX port	2 x 100BASE-FX ports	1 x 100BASE-FX port	2x 100BASE-FX ports	1 + 1 x 100BASE-FX port	
		Connectors	Duplex SC					
		Medium	Multimode optical fiber		Single mode optical fiber		Single mode optical fiber and multimode optical fiber	
		Length of optical fiber	50/125 µm fiber		-		5,000 m (1)	
			62.2/125 µm fiber		-		4,000 m (1)	
			9/125 µm fiber		-		32,500 m (2)	
Attenuation analysis		50/125 µm fiber		-		8 dB		
	62.2/125 µm fiber		-		11 dB			
	9/125 µm fiber		-		16 dB			
	Ethernet services	FDR, SMTP V3, SNMP client, multicast filtering for optimization of the Global Data protocol, configuration via Web access VLAN, IGMP Snooping, RSTP (<i>Rapid Scanning Tree Protocol</i>), priority port, data stream control, secure port						
Topology	Number of switches	Cascaded	Unlimited					
		Redundant in a ring	max. 50					
Redundancy			Redundant power supplies, redundant single ring, ring coupling					
Power supply	Voltage	Operation	9.6...60 V $\overline{\text{---}}$ /18...30 V \sim , safety extra low voltage (SELV)					
	Power consumption		6.5 W	7.3 W	6.5 W	7.3 W		
	Removable connector		6-way					
Operating temperature			0...+ 60 °C					
Relative humidity			10... 90% non condensing					
Degree of protection			IP 20					
Dimensions		W x H x D	74 x 131 x 111 mm					
Mounting			On symmetrical DIN rail, 35 mm wide					
Weight			0.410 kg					
Conformity to standards			IEC 61131-2, IEC 61850-3, UL 508, UL 1604 Class 1 Division 2, CSA C22.2 14 (cUL), CSA C22.2 213 Class 1 Division 2 (cUL), CE, GL					
LED indicators			Power supply status, alarm relay status, active redundancy, redundancy management, fiber port status and fiber port activity					
Alarm relay			Power supply fault, Ethernet network fault or communication port fault (1 A max. volt-free contact at 24 V $\overline{\text{---}}$)					
Reference			TCSESM 083F1CU0	TCSESM 083F2CU0	TCSESM 083F1CS0	TCSESM 083F2CS0	TCSESM 083F2CX0	

(1) Length dependent on the attenuation analysis and attenuation of the fiber optic (typical value: 2,000 m).

(2) Length dependent on the attenuation analysis and attenuation of the fiber optic (typical value: 15,000 m).

Modicon M340 automation platform

Réseau Ethernet TCP/IP, Transparent Ready
Cabling system: ConneXium managed switches

Characteristics and references: 16 and 24 ports, twisted pair, fiber optic

Transparent Ready



Switches			Copper twisted pair and fiber optic, managed	Copper twisted pair, managed	Copper twisted pair and fiber optic, managed
Interfaces	Copper cable ports	Number and type	16 x 10/100BASE-TX ports	14 x 10/100BASE-TX ports	22 x 10/100BASE-TX ports
		Shielded connectors	RJ45		
		Medium	Shielded twisted pair, category CAT 5E		
		Total length of pair	100 m		
	Fiber optic ports	Number and type	–	2 x 100BASE-FX ports	
		Connectors	–	Duplex SC	
		Medium	–	Multimode optical fiber	
		Length of optical fiber	–	–	
		50/125 µm fiber	–	5,000 m (1)	
		62.2/125 µm fiber	–	4,000 m (1)	
		9/125 µm fiber	–	–	
	Ethernet services	Attenuation analysis	–	–	
		50/125 µm fiber	–	8 dB	
		62.2/125 µm fiber	–	11 dB	
9/125 µm fiber		–	–		
Topology	Number of switches	Cascaded	Unlimited		
		Redundant in a ring	max. 50		
Redundancy			Redundant power supplies, redundant single ring, ring coupling		
Power supply	Voltage	Operation	9.6...60 V $\overline{\text{---}}$ /18...30 V \sim , safety extra low voltage (SELV)		
	Power consumption		9.4 W	11.8 W	15.5 W
	Removable connector		6-way		
Operating temperature			0...+ 60 °C		
Relative humidity			10... 90% non condensing		
Degree of protection			IP 20		
Dimensions		W x H x D	111 x 131 x 111 mm		
Mounting			On symmetrical DIN rail, 35 mm wide		
Weight			0.600 kg		0.650 kg
Conformity to standards			cUL 60950, UL 508 and CSA 142, UL 1604 and CSA 213 Class 1 Division 2, C€, GL		
LED indicators			Redundant power supplies, single ring	Redundant power supplies, single ring, double ring	
Alarm relay			Power supply fault, Ethernet network fault or communication port fault (1 A max. volt-free contact at 24 V $\overline{\text{---}}$)		
Reference			TCSESM 163F2CU0	TCSESM 163F23F0	TCSESM 243F2CU0

(1) Length dependent on the attenuation analysis and attenuation of the fiber optic (typical value: 2,000 m).

3
3.

Modicon M340 automation platform

Réseau Ethernet TCP/IP, Transparent Ready
Cabling system: ConneXium managed switches

Characteristics and references: 8 ports and 2 Gigabit ports, twiwted pair, fiber optic



Switches			Copper twisted pair and fiber optic, managed			Copper twisted pair, managed			
Interfaces	Copper cable ports	Number and type	8 x 10/100BASE-TX ports			8 x 10/100BASE-TX ports and 2 x 10/100/1000BASE-TX ports (Gigabit)			
		Shielded connectors	RJ45						
		Medium	Shielded twisted pair, category CAT 5E						
		Total length of pair	100 m						
	Gigabit ports fiber optic (with SFP fiber module to be mounted on SFP connector)	Number and type	2 x 1000BASE-SX ports (1)	2 x 1000BASE-LH ports (2)	2 x 1000BASE-LX ports (3)	-			
			Connectors	LC					
		Medium	Multimode optical fiber	Single mode optical fiber	Single mode and multimode optical fiber	-			
			Length of optical fiber						
		50/125 µm fiber	550 m	-	550 m	-			
		62.2/125 µm fiber	275 m	-	550 m	-			
		9/125 µm fiber	-	8 -72,000 m	20,000 m	-			
		Attenuation analysis	50/125 µm fiber	7.5 dB	-	11 dB	-		
			62.2/125 µm fiber	7.5 dB	-	11 dB	-		
			9/125 µm fiber	-	6 - 22 dB	11 dB	-		
Ethernet services	FDR, SMTP V3, SNTTP client, multicast filtering for optimization of the Global Data protocol, configuration via Web access VLAN, IGMP Snooping, RSTP (<i>Rapid Scanning Tree Protocol</i>), priority port, data stream control, secure port								
Topology	Number of switches	Cascaded	Unlimited						
		Redundant in a ring	max. 50						
Redundancy	Redundant power supplies, redundant single ring, ring coupling								
Power supply	Voltage	Operation	9.6...60 V $\overline{\text{---}}$ /18...30 V \sim , safety extra low voltage (SELV)						
	Power consumption		8.9 W + 1 W per SFP fiber module				8.3 W		
	Removable connector	6-way							
Operating temperature	0...+ 60 °C								
Relative humidity	10... 90% non condensing								
Degree of protection	IP 20								
Dimensions	W x H x D	111 x 131 x 111 mm							
Mounting	On symmetrical DIN rail, 35 mm wide								
Weight	0.410 kg								
Conformity to standards	cUL 60950, UL 508 and CSA 142, UL 1604 and CSA 213 Class 1 Division 2, C€, GL								
LED indicators	Power supply status, alarm relay status, active redundancy, redundancy management, fiber port status and fiber port activity								
Alarm relay	Power supply fault, Ethernet network fault or communication port fault (1 A max. volt-free contact at 24 V $\overline{\text{---}}$)								
Reference	TCS ESM 103F2LG0				TCS ESM 103F23G0				

(1) With TCS EAA F1LFU00 fiber optic module to be ordered separately, see page 3/35.

(2) With TCS EAA F1LFH00 fiber optic module to be ordered separately, see page 3/35.

(3) With TCS EAA F1LFS00 fiber optic module to be ordered separately, see page 3/35.

Modicon M340 automation platform

Réseau Ethernet TCP/IP, Transparent Ready
Cabling system: ConneXium IP 67 switch

Characteristics and references: IP 67 unmanaged switch



IP 67 switch		Twisted pair, unmanaged	
Interfaces	Copper cable ports	Number and type	5 x 10BASE-T/100BASE-TX ports
		Shielded connectors	M12 (type D)
		Medium	Shielded twisted pair, category CAT 5E
		Total length of pair	100 m
	Fiber optic ports	Number and type	–
		Connectors	–
		Medium	–
Ethernet services	Length of optical fiber	–	
	Attenuation analysis	–	
	Storage and re-routing of received data, auto MDI/MDX (automatic switching depending on whether cables are straight or crossed), automatic negotiation of 10/100 Mbps and duplex mode (on all ports), automatic change of polarity		
Topology	Number of switches	Cascaded	Unlimited
		Redundant in a ring	–
Redundancy		–	
Power supply	Voltage	24 V $\bar{\text{---}}$ (18...32 V $\bar{\text{---}}$), safety extra low voltage (SELV)	
	Power consumption	100 mA	
	Connector	5-way M12 (type A, male)	
Operating temperature		0...+ 60°C	
Relative humidity		–	
Degree of protection		IP 67	
Dimensions W x H x D		60 x 126 x 31 mm	
Weight		0.210 kg	
Conformity to standards		cUL 508 and CSA 22.2 14	
LED indicators		Power supply, line status, line activity	
Alarm relay		–	
Reference		TCS ESU 051 F0	

IP 67 cordsets			
Ethernet cordsets		Preformed at each end, see page 3/35	
Power supply cables		Preformed at each end with M12 female straight connectors	Preformed at each end with female M12 angled connectors
Length	2 m	5 m	2.5 m
			5 m
Reference		XZC P1164L2	XZC P1164L5
		XZC P1264L2	XZC P1264L5
Spare power connectors		Female M12 straight connector	Female M12 angled connector
Reference		XZC C12 FDM 50B	XZC C12 FCM 50B

Modicon M340 automation platform

Réseau Ethernet TCP/IP, Transparent Ready
Cabling system: Connexium connection components

Shielded copper connection cables

ConneXium shielded connection cables are available in two versions to meet the various current standards and approvals:

- EIA/TIA 568 standard shielded twisted pair cables

These cables conform to:

- EIA/TIA-568 standard, category CAT 5E,
- IEC 11801/EN 50173 standard, class D.

Their fire resistance conforms to:

- NFC 32070# C2 classification
- IEC 322/1 standards
- Low Smoke Zero Halogen (LSZH).

- UL and CSA 22.1 approved shielded twisted pair cables

These cables conform to:

- UL and CSA 22.1 standards
- Their fire resistance conforms to NFPA 70.

EIA/TIA 568 standard shielded twisted pair cables

Description	Preformed at both ends	Length	Reference	Weight kg
Straight cables	2 RJ45 connectors For connection to terminal devices (DTE)	2 m	490 NTW 000 02	—
		5 m	490 NTW 000 05	—
		12 m	490 NTW 000 12	—
		40 m	490 NTW 000 40	—
		80 m	490 NTW 000 80	—
Crossed cord cables	2 RJ45 connectors For connections between hubs, switches and transceivers	5 m	490 NTC 000 05	—
		15 m	490 NTC 000 15	—
		40 m	490 NTC 000 40	—
		80 m	490 NTC 000 80	—

UL and CSA 22.1 approved shielded twisted pair cables

Description	Preformed at both ends	Length	Reference	Weight kg
Straight cables	2 RJ45 connectors For connection to terminal devices (DTE)	2 m	490 NTW 000 02U	—
		5 m	490 NTW 000 05U	—
		12 m	490 NTW 000 12U	—
		40 m	490 NTW 000 40U	—
		80 m	490 NTW 000 80U	—
Shielded cables	2 RJ45 connectors For connections between hubs, switches and transceivers	5 m	490 NTC 000 05U	—
		15 m	490 NTC 000 15U	—
		40 m	490 NTC 000 40U	—
		80 m	490 NTC 000 80U	—

Glass fiber optic cables

These glass fiber optics are for making connections:

- To a terminal device (DTE)
- Between hubs, transceivers and switches

Description	Preformed at both ends	Length	Reference	Weight kg
Glass fiber optic cables	1 SC connector 1 MT-RJ connector	5 m	490 NOC 000 05	—
		5 m	490 NOT 000 05	—
	2 MT-RJ connectors	3 m	490 NOR 000 03	—
		5 m	490 NOR 000 05	—
		15 m	490 NOR 000 15	—



490 NTW 000 00



490 NOC 000 05



490 NOT 000 05



490 NOR 000 05

Modicon M340 automation platform

Réseau Ethernet TCP/IP, Transparent Ready
Cabling system: ConneXium connection components



TCS EAA F1LF00

Separate parts for TCS ESM switches

Description	Optical fiber	Type	Reference	Weight kg
Fiber optic modules for Gigabit ports with LC connector (1)	Multimode 50/125µm or 62.5/125µm	1000BASE-SX	TCS EAA F1LFU00	0.040
	Single mode 9/125µm	1000BASE-LH	TCS EAA F1LFH00	0.040
	Multimode 50/125µm or 62.5/125µm Single mode 62.5/125µm	1000BASE-LX	TCS EAA F1LFS00	0.040
Configuration backup key	Via the USB port on the front of the switch, used to: - save and retrieve the switch configuration - update the internal software		TCS EAM 0100	-

Connection components for IP 67 switch

Description	Preformed at both ends	Length	Reference	Weight kg
Copper cables	1 IP 67 4-way M12 connector and 1 RJ45 connector	1 m	TCS ECL 1M3M 1S2	-
		1.5 m	TCS ECL 1M3M 1X5S2	-
		3 m	TCS ECL 1M3M 3S2	-
		5 m	TCS ECL 1M3M 5S2	-
		10 m	TCS ECL 1M3M 10S2	-
		25 m	TCS ECL 1M3M 25S2	-
		40 m	TCS ECL 1M3M 40S2	-
	2 IP 67 4-way M12 connectors	1 m	TCS ECL 1M1M 1S2	-
		1.5 m	TCS ECL 1M1M 1X5S2	-
		3 m	TCS ECL 1M1M 3S2	-
		5 m	TCS ECL 1M1M 5S2	-
		10 m	TCS ECL 1M1M 10S2	-
		25 m	TCS ECL 1M1M 25S2	-
40 m	TCS ECL 1M1M 40S2	-		
M12/RJ45 adaptor	IP 67 female 4-way M12 connector and female RJ45 connector	-	TCS EAA F11F13F00	-

(1) Dimensions W x H x D = 20 x 18 x 50 mm.

Modicon M340 automation platform

CANopen machine and installation bus

Presentation

Schneider Electric has selected CANopen for its machines and installations because of its wealth of functions and its resulting benefits in the automation world. This decision was based on the general acceptance of CANopen, and the fact that CANopen products are increasingly used in control system architectures.

CANopen is an open network supported by more than 400 companies worldwide, and promoted by CAN in Automation. CANopen conforms to standards EN 50325-4 and ISO 15745-2.

Schneider Electric is heavily involved in working groups, which are important for machine and installation architectures, systems and products.

CANopen brings transparency to Ethernet

CAN in Automation and Modbus-IDA have worked together to create a standard that ensures total transparency between CANopen and Modbus TCP/IP. The result of this collaboration has been the CiA DSP309-2 specification, defining communication standards between a Modbus TCP/IP network and a CANopen bus.

The specification defines mapping services enabling CANopen devices to communicate with a Modbus TCP/IP network through a gateway. The data in a CANopen device can be accessed in both read and write mode.

This specification is the first standard available for developing an open standard communication between Modbus TCP/IP and CANopen. It is driving Schneider Electric network solutions toward better integration, diagnostics and configuration of distributed applications. It allows machines and installations to be connected to an Ethernet network continuously, while combining the advantages of each network in its specific area.

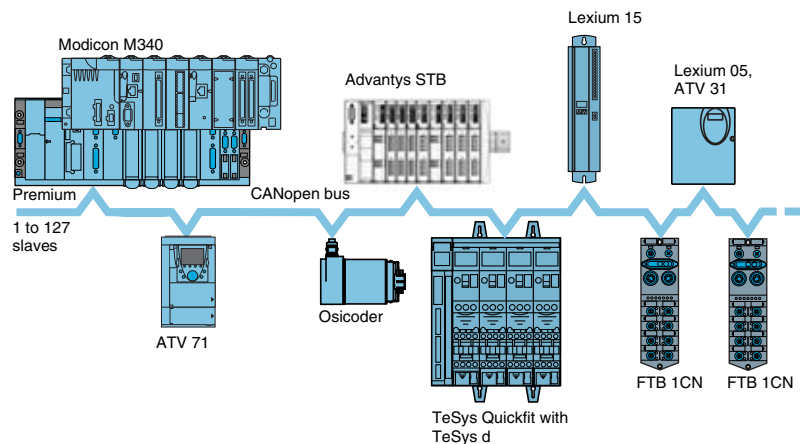

The CANopen bus is a multi-master bus ensuring reliable, deterministic access to real-time data in control system devices. The CSMA/CA protocol is based on broadcast exchanges, sent cyclically or on an event, to ensure optimum use of the passband. A message handling channel can also be used to define slave parameters.

The bus uses a double twisted pair on which, with the Modicon M340 platform, 63 devices maximum are connected by daisy-chaining or by tap junctions. The variable data rate between 20 Kbps and 1 Mbps depends on the length of the bus (between 20 m and 2,500 m).

Each end of the bus must be fitted with a line terminator.

The CANopen bus is a set of profiles on CAN systems, possessing the following characteristics:

- Open bus system
- Data exchanges in real time without overloading the protocol
- Modular design allowing modification of size
- Interconnection and interchangeability of devices
- Standardized configuration of networks
- Access to all device parameters
- Synchronization and circulation of data from cyclic and/or event-controlled processes (short system response time)

Modicon M340 automation platform

CANopen machine and installation bus



Advantys FTB



Advantys OTB



TeSys Quickfit



Altivar ATV 31

Example of devices that can be connected on CANopen

Connectable devices

The Modicon M340 automation platform, via its **BMX P34 2010/2030** processors with integrated CANopen link, performs the role of master on the machine bus.

The following Telemecanique devices can be connected to the CANopen bus:

- **XCC 3510P/3515C S84CB** Ø 58 mm Osicoder multi-turn absolute encoders
- TeSys model d motor-starters, using the TeSys Quickfit installation help system (with **APP 1CCO0/O2** communication module)
- **OTB 1C0 DM9LP** Advantys OTB IP 20 Optimum distributed I/O with interface module (I/O extension modules not permitted)
- **STB NCO 1010/2212** Advantys STB IP 20 modular distributed I/O via NIM module
- **FTB 1CN** Advantys FTB IP 67 monobloc I/O splitter boxes
- **XPS MC16ZC/32ZC** Preventa configurable safety controllers
- **ATV 31H** variable speed drives for 0.18...15 kW Altivar 31 asynchronous motors (versions 1.1, 1.2 and 1.3)
- **ATV 61H /71H** variable speed drives for 0.75...630 kW Altivar 71/61 asynchronous motors
- **LXM 05A/D** Lexium 05 servo drives (0.4...6 kW) for BSH servo motors.
- **LXM 15L/ 15MD/15HC** Lexium 15 servo drives (0.9...42.5 kW) for BDH or BSH servo motors
- **IFE 71, IFA 6, IFS 6/9** ICLA intelligent compact motor-drives from Berger Lahr (part of the Schneider Electric group)

Software setup via Unity Pro

Configuration of the CANopen bus on the Modicon M340 platform is fully integrated in the Unity Pro software. From the Unity Pro graphic editor, simply select the devices available in the catalog and assign them their CANopen slave address. Exchanges between the CANopen bus and the Modicon M340 processor can be assigned by configuration to the fast or master task.

Predefined profiles or functions are used to create the user interface automatically using process variables (PDO), in such a way that any subsequent modification to the mapping of these variables will have no impact on their topological addressing. Depending on the devices, dedicated configuration screens are used to assign the initial parameters.

Finally, an “expert” mode is also available for CANopen specialists who wish to optimize the performance of the CANopen bus or re-assign the process variables differently (PDO).

Acyclical access to the service data (SDO) corresponding to any CANopen object of a particular device is easily possible from the application using the standard communication functions READ_VAR and WRITE_VAR, or even from the Unity Pro diagnostic screens.

These screens can be used to display the bus status graphically, as well as to access the diagnostics sent by a faulty device with a single click of the mouse.

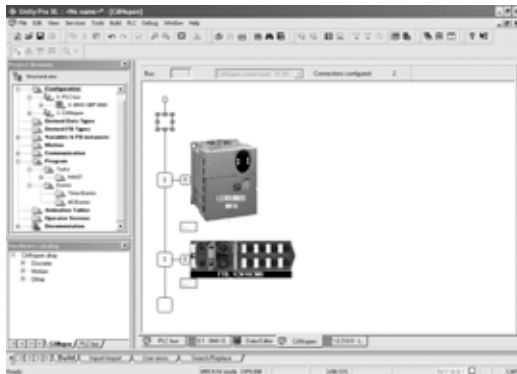

Example of Unity Pro configuration screen for Lexium 05 servo drive and Advantys FTB IP 67 I/O splitter box

Modicon M340 automation platform

CANopen machine and installation bus

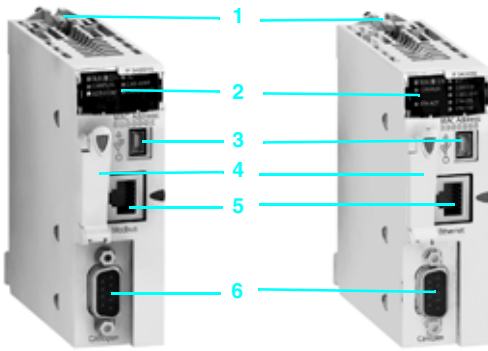

BMX P34 2010

BMX P34 2030

Description

Both of the Performance processors on the Modicon M340 platform, **BMX P34 2010** and **BMX P34 2030**, have an integrated CANopen communication port. They have the following on the front panel:

- 1 Safety screw for locking the module in its slot (marked 0) in the rack
- 2 A display block comprising at least:
 - CAN RUN LED (green): Integrated machine/installation bus operational
 - CAN ERR LED (red): Integrated machine/installation bus faulty
- 3 A mini B USB connector for a programming terminal
- 4 A slot equipped with Flash memory card for backing up the application
- 5 An RJ45 connector for serial link (with **BMX P34 2010** model) or Ethernet TCP/IP port (with **BMX P34 2030** model)
- 6 A 9-way SUB-D connector for the CANopen Master machine and installation bus

Characteristics (1)

Type of bus		CANopen								
CANopen services	Conformity class	M20								
	Standard	DS 301 V 04.02, 303-2								
	Device profile	DS 405								
	Special	-								
Structure	Physical interface	9-way male SUB-D								
	Topology	Devices connected by daisy-chaining and/or tap junctions								
	Access method	CSMA/CA, carrier sense consumer/producer principle, collision detection and arbitration of message priorities								
	Application layer	Messages carrying objects: process data (PDO), service data (SDO), network management (NMT), special functions (SYNC, EMCY, TIME)								
Transmission	Data rate	20 Kbps...1 Mbps depending on bus length								
	Medium	Double shielded twisted pair								
CANopen physical configuration	No. of slave devices	63 maximum								
	Data rate	1 Mbps	800 Kbps	500 Kbps	250 Kbps	125 Kbps	50 Kbps	20 Kbps		
	Maximum length of bus	m	20	40	100	250	500	1000	2500	
	Maximum length of tap-offs on one tap junction (2)	m	0.6	6	10	10	10	120	300	
	Limitation per segment	No. of devices	64	32	16					
Maximum length of segment (4)		m	160	185	205					
Modicon M340 processor			BMX P34 2010				BMX P34 2030			
	No. of racks	1 (4, 6, 8 or 12 slots)								
	Maximum no. of slots	12 for processor and modules (excluding power supply module)								
	Maximum no. in rack	Discrete I/O	1,024, 704 in single-rack configuration (64 I/O x 11)							
		Analog I/O	256, 66 in single-rack configuration (4I/2Q x 11)							
		Process control	Programmable loops (via CONT-CTL process control EFB library)							
		Counting	36 channels							
	Integrated connections	Motion	Independent axes on CANopen bus (via MFB library)							
		Ethernet TCP/IP	-				1 RJ45 port, 10/100 Mbps			
		CANopen bus	1 master (9-way SUB-D)							
Serial link		1 RJ45 port, Modbus master/slave or character mode -								
Communication module	USB port	1 port, 12 Mbps								
	Ethernet TCP/IP	1 RJ45 port, 10/100 Mbps, with Transparent Ready class B30 standard eeb server or Transparent Ready class C30 configurable web server (with BMX RWS 016MC card)								
Internal RAM capacity	Kb	4,096 including 3,584 for the program, constants and symbols and 256 for data								

(1) For more information, please refer to the "Machines and installations with CANopen" catalog.
 (2) For other restrictions, please refer to the CANopen hardware setup manual available on our website (www.telemecanique.com).

(3) Deduct 15 m per repeater from the length of the bus.

(4) With the use of **TSX CAN C●50/100/300** CANopen cables and **TSX CAN C●DD03/1/3/5** preformed cordsets.

Modicon M340 automation platform

CANopen machine and installation bus

Modicon M340 Performance processors with integrated CANopen bus link



BMX P34 2010



BMX P34 2030

Modicon M340 processor modules are supplied with the **BMX RMS 008MP** Flash memory card. This card performs the following actions transparently:

- Backing up the application (program, symbols and constants) supported in the processor internal RAM that is not backed up
- Activation of the Transparent Ready class B10 standard web server (with **BMX P34 2030** processor)

This card can be replaced by another card featuring a file storage option (see page 1/9).

I/O capacity (1)	Memory capacity	Max. no. of network modules	Integrated communication ports	Reference (3)	Weight kg
Performance BMX P340 20, 1 rack					
1,024 discrete I/O 256 analog I/O 36 app-sp. channels	4,096 Kb integrated	1 Ethernet TCP/IP network	CANopen bus Modbus serial link	BMX P34 2010	—
			CANopen bus Ethernet TCP/IP network	BMX P34 2030	—

(1) For I/O capacity in single-rack configuration, see characteristics, page 1/8

CANopen bus wiring system

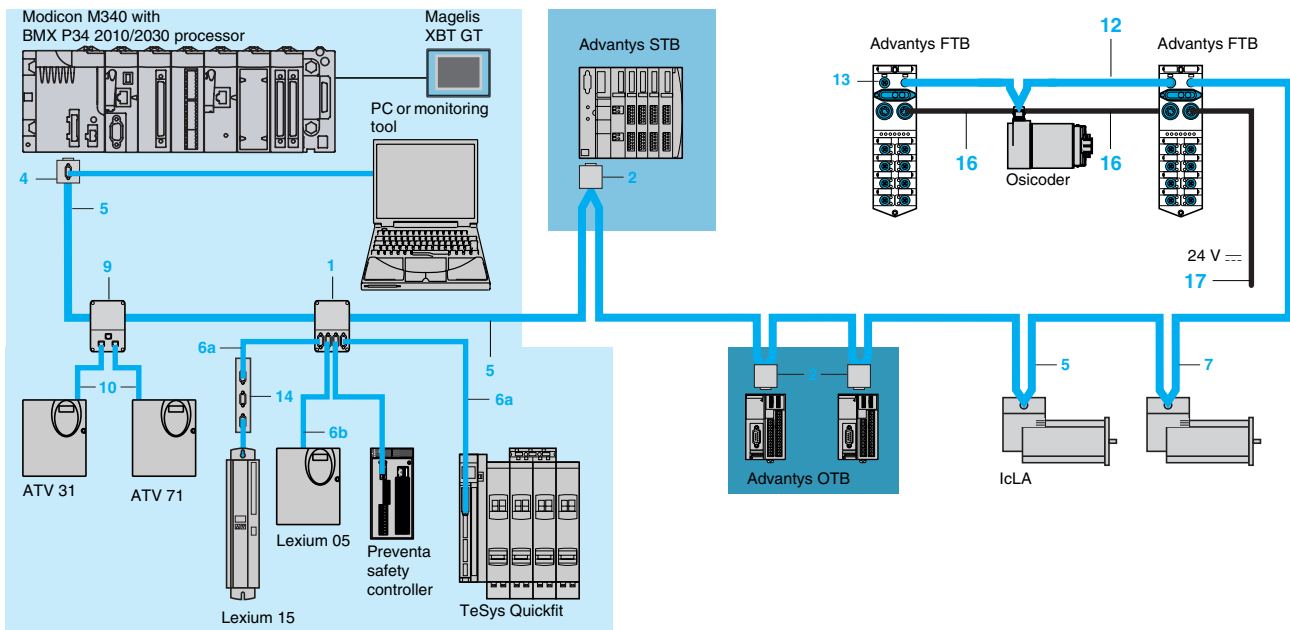

Note: For numbers and references 1, 2, ..., 17, see pages 3/40 and 3/41.

Different types of cable are available making it possible to create any type of application, including for harsh environments (for a definition of standard and harsh environments, see page 3/40).

Several connectors are available to meet any requirement: straight or 90° angled connectors, or angled connectors with the option of connecting a PC or diagnostic pocket PC.

Power can be supplied to the equipment by means of cables, cordsets and tap junctions: one AWG24 pair for the CAN signals, one AWG22 pair for the power supply and the ground.

In addition to the IP 20 wiring offer, there is also an IP 67 wiring offer.

Modicon M340 automation platform

CANopen machine and installation bus Wiring system



TSX CAN TDM4



VW3 CAN TAP2



TSX CAN KCD F90T



TSX CAN KCD F180T



TSX CAN KCD F90TP

Standard tap junctions and connectors

Designation	Description	No. (1)	Length	Reference	Weight kg
IP 20 CANopen tap junction	4 SUB-D ports. Screw terminal block for connection of trunk cables Line termination	1	–	TSX CAN TDM4	0.196
IP 20 connectors CANopen female	90° angled	2	–	TSX CAN KCDF 90T	0.046
	Straight (2)	–	–	TSX CAN KCDF 180T	0.049
	9-way SUB-D. Switch for line termination	4	–	TSX CAN KCDF 90TP	0.051
IP 67 M12 connectors	Male	–	–	FTX CN 12M5	0.050
	Female	–	–	FTX CN 12F5	0.050
IP 20 CANopen tap junctions for Altivar and Lexium 05	2 RJ45 ports	9	–	VW3 CAN TAP2	–

IP 20 standard cables and preformed cordsets

Designation	Description	No. (1)	Length	Unit reference	Weight kg	
CANopen cables (AWG 24)	Standard, C€ marking: low smoke. Halogen-free. Flame-retardant (IEC 60332-1)	5	50 m	TSX CAN CA50	4.930	
			100 m	TSX CAN CA100	8.800	
			300 m	TSX CAN CA300	24.560	
	Standard, UL certification, C€ marking: flame-retardant (IEC 60332-2)	5	50 m	TSX CAN CB50	3.580	
			100 m	TSX CAN CB100	7.840	
			300 m	TSX CAN CB300	21.870	
	For harsh environments (3) or mobile installation, C€ marking: low smoke. Halogen-free. Flame-retardant (IEC 60332-1). Resistance to oils	5	50 m	TSX CAN CD50	3.510	
			100 m	TSX CAN CD100	7.770	
			300 m	TSX CAN CD300	21.700	
CANopen preformed cordsets One 9-way female SUB-D connector at each end (AWG 24)	Standard, C€ marking: low smoke. Halogen-free. Flame-retardant (IEC 60332-1)	6a	0.3 m	TSX CAN CADD03	0.091	
			1 m	TSX CAN CADD1	0.143	
			3 m	TSX CAN CADD3	0.295	
			5 m	TSX CAN CADD5	0.440	
			Standard, UL certification, C€ marking: flame-retardant (IEC 60332-2)	6a	0.3 m	TSX CAN CBDD03
	1 m	TSX CAN CBDD1	0.131			
	3 m	TSX CAN CBDD3	0.268			
	5 m	TSX CAN CBDD5	0.400			
	CANopen preformed cordsets One 9-way SUB-D connector, One RJ45 connector (AWG 24)	Standard, C€ marking: low smoke. Halogen-free. Flame-retardant (IEC 60332-1)	6b		0.5 m	TCS CCE 4F3M05
				1 m	TCS CCE 4F3M1	–
Standard, UL certification, C€ marking: flame-retardant (IEC 60332-2)		6b	0.5 m	TCS CCU4F3M05	–	
			1 m	TCS CCU 4F3M1	–	
CANopen preformed cordsets	Two 9-way SUB-D connectors, one male and one female	–	0.5 m	TLA CD CBA 005	–	
			1.5 m	TLA CD CBA 015	–	
			3 m	TLA CD CBA 030	–	
			5 m	TLA CD CBA 050	–	
			–	–	–	

IP 67 standard preformed cordsets

Designation	Description	No. (1)	Length	Unit reference	Weight kg
CANopen preformed cordsets	Preformed cordsets of two 5-way M12 A-coded angled connectors (one male connector and one female connector)	12	0.3 m	FTX CN 3203	0.40
			0.6 m	FTX CN 3206	0.70
			1 m	FTX CN 3210	0.100
			2 m	FTX CN 3220	0.160
			3 m	FTX CN 3230	0.220
			5 m	FTX CN 3250	0.430
	Preformed cordsets with one 5-way female M12 A-coded connector at one end and flying leads at the other end	7	3 m	FTX CN 3130	–
5 m	FTX CN 3150	–			

(1) For numbers, see page 3/39.

(2) For connection to Controller Inside programmable card, the VW3 CAN KCDF 180T connector can also be used.

(3) **Standard environment:**

- Without any particular environmental constraints
- Operating temperature between +5°C and +60°C
- Fixed installation

Harsh environment:

- Resistance to hydrocarbons, industrial oils, detergents, solder splashes
- Relative humidity up to 100%
- Saline atmosphere
- Significant temperature variations
- Operating temperature between -10°C and +70°C
- Mobile installation

Modicon M340 automation platform

CANopen machine and installation bus

Wiring system



VW3 CAN A71



AM0 2CA 001V000

IP 20 connection accessories

Designation	Description	No. (1)	Length	Unit reference	Weight kg
CANopen connector for Altivar 71 drive (2)	9-way female SUB-D. Switch for line termination. Cables exit at 180°	–	–	VW3 CAN KCDF 180T	–
Adaptor for Altivar 71 drive	CANopen adaptor SUB-D to RJ45	–	–	VW3 CAN A71	–
Preformed CANopen cordsets for Altivar and Lexium 05 drives	One RJ45 connector at each end	10	0.3 m	VW3 CAN CARR03	–
		–	1 m	VW3 CAN CARR1	–
CANopen bus adaptor for Lexium 15 servo drive	Hardware interface for a link conforming to the CANopen standard + one connector for a PC terminal	14	–	AM0 2CA 001V000	0.110
Y-connector	CANopen/Modbus	–	–	TCS CTN011M11F	–

IP 67 connection accessories

For Advantys FTB monobloc I/O splitter boxes

Designation	Composition	No. (1)	Length m	Reference	Weight kg
IP 67 line terminator	Equipped with one M12 connector (for end of bus)	13	–	FTX CNTL12	0.010
24 V \equiv power supply connection cables	Equipped with two 5-way 7/8 connectors	16	0.6	FTX DP2206	0.150
		–	1	FTX DP2210	0.190
		–	2	FTX DP2220	0.310
		–	5	FTX DP2250	0.750
		–	17	1.5	FTX DP2115
	Equipped with one 5-way 7/8 connector at one end and flying leads at the other end	–	3	FTX DP2130	0.430
		–	5	FTX DP2150	0.700
		–	–	–	–
T-junction box for power supply	Equipped with two 5-way 7/8 connectors	–	–	FTX CNCT1	0,100

FTX DP21●●

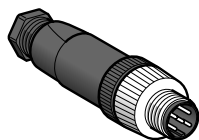

XZ CC12DM50B

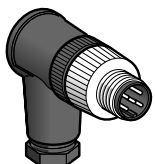

XZ CC12CM50B



FTX CY1208

Separate parts

Designation	Composition	Sold in	Reference	Weight kg	
Connectors	7/8 type, 5-way	Male	–	FTX C78M5	0.050
		Female	–	FTX C78F5	0.050
	Straight, M12 type, 5 screw terminals	Male	–	XZ CC12MDM50B	0.020
		Female	–	XZ CC12FDM50B	0.020
		Male	–	XZ CC12MCM50B	0.020
		Female	–	XZ CC12FCM50B	0.020
Sealing plugs	For M8 connector (sold in packs of 10)	–	FTX CM08B	0.100	
	For M12 connector (sold in packs of 10)	–	FTX CM12B	0.100	
	For 7/8 connector	–	FTX C78B	0.020	
Y-connector	Connection of two M8 connectors to M12 connector on splitter box	–	FTX CY1208	0.020	
	Connection of two M12 connectors to M12 connector on splitter box	–	FTX CY1212	0.030	
Diagnostics adaptor	Equipped with two M12 connectors	–	FTX DG12	0.020	
Marker labels	For plastic splitter boxes	Packs of 10	FTX BLA10	0.010	
	For metal splitter boxes	Packs of 10	FTX MLA10	0.010	

(1) For numbers, see page 3/39.

(2) For ATV 71H●●●M3, ATV 71HD11M3X, HD15M3X, ATV 71H075N4... HD18N4 drives, this connector can be replaced by the TSX CAN KCDF 180T connector.

Presentation

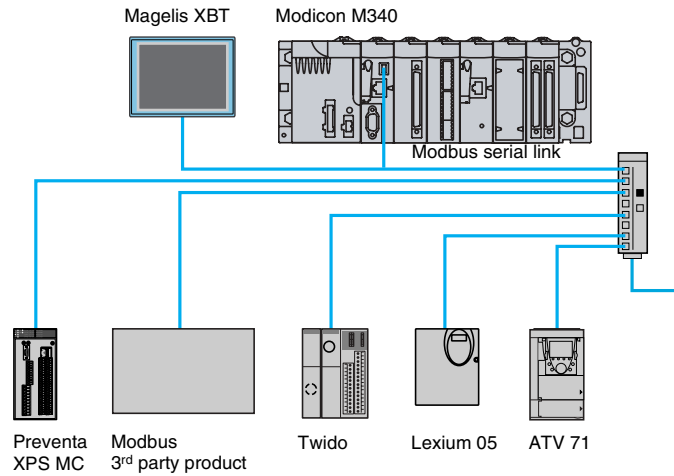

The Modbus bus is used for master/slave architectures (it is necessary, however, to check that the Modbus services used by the application are implemented on the devices concerned).

The bus comprises one master station and several slave stations. Only the master station can initiate the exchange (direct communication between slave stations is not possible). Two exchange mechanisms are possible:

- Question/answer, where the requests from the master are addressed to a given slave. The master then waits for the response from the slave which has been interrogated.
- Broadcasting, the master broadcasts a message to all the slave stations on the bus. These stations execute the order without transmitting a response.

Description

The **BMX P34 1000 / 2010 / 2020** processors in the Modicon M340 automation platform range integrate a serial link that can operate under Modbus master/slave RTU/ASCII protocol or under character mode protocol.

For this serial port, these processors have the following on the front panel :

- 3 A display block comprising among other LEDs:
 - SER COM LED (yellow): Activity on the Modbus serial link (lit) or failure on an equipment present on the link (flashing).
- 4 An RJ45 connector for the Modbus serial link or character mode link (RS 232C/RS 485, non-isolated) and its black indicator 3.

Nota : Complete processors descriptions, see page 1/5.

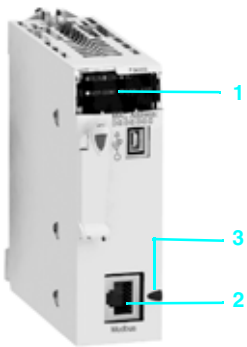

BMX P34 1000

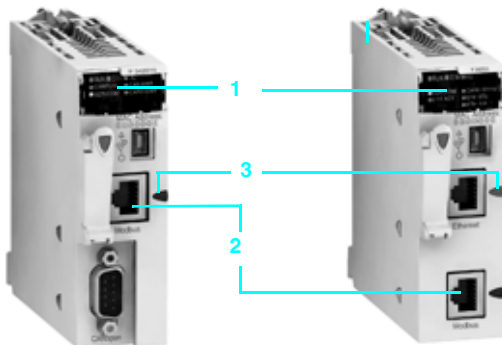

BMX P34 2010

BMX P34 2000



Modicon M340 automation platform

Modbus serial link and character mode

Characteristics					
Protocol		Modbus		Character mode	
Structure	Type	Non isolated serial link (1)			
	Method of access	Master/slave type			
	Physical Interface	RS 232, 2 wires	RS 485, 2 wires	RS 232, 4 wires	RS 485, 2 wires
Transmission	Mode	Asynchronous in baseband			
	Frame	RTU/ASCII, Half duplex		Full duplex	Half duplex
	Data rate	0.3...19.2 Kbit/s (default 19.2 Kbit/s)			
	Medium	Shielded twisted pair		Simple or double shielded twisted pair	Shielded twisted pair
Configuration	Number of devices	2 (point-to-point)	32 max. per segment	2 (point-to-point)	32 max. per segment
	Maximum number of link addresses	248		248	
	Maximum length of bus	15 m	10 m non isolated link 1000 m isolated link	15 m	10 m non isolated link 1000 m isolated link
	Maximum length of tap links	–	15 m non isolated link 40 m isolated link	–	15 m non isolated link 40 m isolated link
Services	Requests	252 data bytes per RTU request 504 data bytes per ASCII request		1 K data bytes per request	
	Security, control parameters	One CRC on each frame (RTU) One LRC on each frame (ASCII)		One LRC on each frame (ASCII)	
	Monitoring	Diagnostic counters, event counters		–	

(1) For an isolated link, you must use the TWD XCA ISO terminal port cable connector.

Modbus functions			
Modbus functions available on serial ports integrated to Modicon M340 processors	Code	Modbus slave (server)	Modbus master (client)
	01	Read n output bits	Read output bits
	02	Read n input bits	Read input bits
	03	Read n output words	Read words
	04	Read n input words	Read input words
	15	Write n output bits	Write n output bits
	16	Write n output words	Write n output words

References					
	I/O capacity (1)	Memory capacity	Integrated communication ports	Reference (3)	Mass kg
 	Standard processor with integrated serial link BMX P340 10				
	512 discrete I/O 128 E/S analog I/O 20 application-specific channels	2,048 Kb integrated	Modbus serial link	BMX P34 1000	0.200
Performance processors with integrated serial link BMX P340 20					
	1024 discrete I/O 256 E/S analog I/O 36 application-specific channels	4,096 Kb integrated	Modbus serial link CANopen bus	BMX P34 2010	0.210
			Modbus serial link Ethernet TCP/IP network	BMX P34 2020	0.205

BMX P34 1000

BMX P34 2020

Serial link cabling system, see pages 3/44 and 3/45.

Modicon M340 automation platform

Modbus serial link and character mode
Cabling system

Cabling system

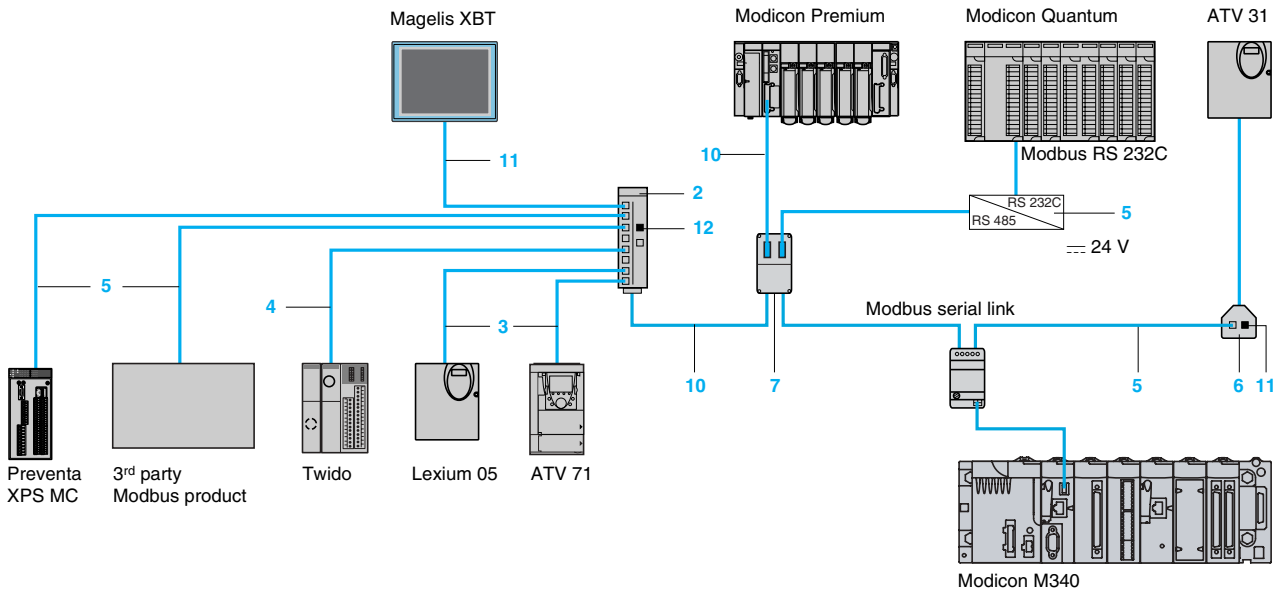

Extension and adaptation elements for RS 485 serial link

Designation	Description	Reference	Length	Unit reference	Weight kg
Modbus splitter box	10 x RJ45 connectors and 1 x screw terminal block	1	–	LU9 GC3	0.500
T-junction boxes	2 x RJ45 connectors, 1 x integrated cable with RJ45 connector	2	0.3 m 1 m	VW3 A8 306 TF03 VW3 A8 306 TF10	– –
Passive T-junction box	Tap-off point, extension of trunk cable and line termination adapter	–	–	TSX SCA 50	0.520
Passive 2-channel subscriber socket	2 x 15-way female SUB-D connectors and 2 x screw terminals	3	–	TSX SCA 62	0.570
T-junction box	Insulation of the RS 485 serial line and Screw terminals for main line termination adaptation	4	–	TWD XCA ISO	0.100
T-junction box	Mounting on 35 mm 3 x RJ45 connectors	–	–	TWD XCA T3RJ	0.080
Modbus / Bluetooth® adapter	1 x Bluetooth® adapter (10 m range, class 2) with 1 x RJ45 connector, 1 x 0.1 m long cordset for PowerSuite with 2 x RJ45 connectors, 1 x 0.1 m long cordset for TwidoSuite with 1 x RJ45 connector and 1 x mini DIN connector, 1 x RJ45/SUB-D male 9-way adapter for ATV speed drives	–	–	VW3 A8114	0.155
RS 232C/RS 485 line adapter	24 V 20 mA power supply, 19.2 kbps signals	5	–	XGS Z24	0.100

(1) 24 V power supply external or thru the serial port integrated to Modicon M340 processors.



LU9 GC3



TSX SCA 50



TSX SCA 62



XGS Z24



TWD XCA ISO



TWD XCA T3RJ

Modicon M340 automation platform

Modbus serial link and character mode

Cables and connecting cordsets for RS 485 serial link

Designation	Description	Reference	Length	Unit reference	Weight kg
RS 485 double shielded twisted pair trunk cables	Modbus serial link, supplied without connector	6	100 m	TSX CSA 100	5.680
			200 m	TSX CSA 200	10.920
			500 m	TSX CSA 500	30.000
Modbus RS 485 cables	2 x RJ45 connectors	7	0.3 m	VW3 A8 306 R03	0.030
			1 m	VW3 A8 306 R10	0.050
			3 m	VW3 A8 306 R30	0.150
	1 x RJ45 connector and 1 x 15-way SUB-D connector	–	3 m	VW3 A8 306	0.150
	1 x mini-DIN connector for Twido controller and 1 x RJ45 connector	4	0.3 m	TWD XCA RJ003	0.040
			1 m	TWD XCA RJ010	0.090
			3 m	TWD XCA RJ030	0.160
	1 x RJ45 connector and 1 end with flying leads	5	3 m	VW3 A8 306 D30	0.150
	1 x miniature connector and 1 x 15-way SUB-D connector (1)	9	3 m	TSX SCP CM 4530	0.180
Cordset for Magelis XBT N/R display and compact terminal	1 x RJ45 connector and 1 x 25-way SUB-D connector	11	2.5 m	XBT Z938	0.210
Cordset for Magelis XBT GT touch-sensitive graphic terminal	2 x RJ45 connectors for : - XBT GT1 (COM1 port) - XBT GT2...GT7 (COM2 port)	11	3 m	VW3 A8 306 R30	0.150
	1 x RJ45 connector and 1 x 25-way SUB-D connector for: - XBT GT2...GT7 (COM1 port)	11	2.5 m	XBT Z938 (1)	0.210
Line terminator	For RJ45 connector R = 120 Ω, C = 1 nf	12	<i>Sold in lots of 2</i>	VW3 A8 306 RC	0.200

Connecting cordsets for RS 232 serial link

Designation	Description	Reference	Length	Unit reference	Weight kg
Cordset for Data Terminal Equipment (DTE: printer...)	Serial link for Data Terminal Equipment (DTE) (2) 1 x RJ45 connector and 1 x 9-way SUB-D female connector	–	3 m	TCS MCN 3M4F3C2	0.150
Cordset for Data Communication Equipment (DCE: modem, converter...)	Serial link for point-to-point equipment (DCE) 1 x RJ45 connector and 1 x 9-way SUB-D male connector	–	3 m	TCS MCN 3M4M3S2	0.150

(1) Must be associated with an **XBT ZG909** adapter.

(2) If the DTE is equipped with a 25-way SUB-D connector, additionally order the 25-way female / 9-way male SUB-D **TSX CTC 07** adapter.

4 - Unity software

Unity software selection guide page 4/2

- Unity Pro programming software
 - Presentation, setup page 4/4
 - Software structure page 4/9
 - 5 IEC languages page 4/12
 - Functions page 4/18
 - References page 4/29
- Unity EFB Toolkit software page 4/32
- Unity SFC View software page 4/34
- Unity Loader software page 4/36



Modicon M340 automation platform

Unity software

Unity Pro programming software for:

- Modicon M340 **M**
- Premium **P**, Atrium **A**
- Quantum **Q**







4

IEC 61131-3 languages	Instruction List (IL)	M	M - A - P	M - A - P - Q	M - A - P - Q	
	Ladder (LD)	M	M - A - P	M - A - P - Q	M - A - P - Q	
	Structured Text (ST)	M	M - A - P	M - A - P - Q	M - A - P - Q	
	Function Block Diagram (FBD)	M	M - A - P	M - A - P - Q	M - A - P - Q	
	Sequential Function Chart (SFC)/Grafcet	M	M - A - P	M - A - P - Q	M - A - P - Q	
	Programming services	Multitask programming (Master, fast and event-triggered)	M	M - A - P	M - A - P - Q	M - A - P - Q
		Multitask programming (Master, fast, auxiliary and event-triggered)				P (TSX P57 5●) Q (140 CPU 651/671)
		Functional view and function modules	M	M - A - P	M - A - P - Q	M - A - P - Q
		DFB editor and DFB instances	M	M - A - P	M - A - P - Q	M - A - P - Q
		DDT compound data editor	M	M - A - P	M - A - P - Q	M - A - P - Q
Data structure instances and tables		M	M - A - P	M - A - P - Q	M - A - P - Q	
EF function block libraries and EFB function blocks		M	M - A - P	M - A - P - Q	M - A - P - Q	
User-definable control loops			A (TSX PCI 2●) - P (TSX P57 2●)	A (TSX PCI 20●) - P (TSX P57 2●/3●/4●)	P (TSX P57 2●/3●/4●/5●)	
Programmable control loops (FB library)		M	M - A - P	M - A - P - Q	M - A - P - Q	
Motion Function Blocks		M	M - A - P	M - A - P	M - A - P	
Hot Standby PLC redundancy system			P (TSX H57 24M)	P (TSX H57 24/44M)	P (TSX H57 24/44M) - Q (140 CPU 67 160)	
System diagnostics		M	M - A - P	M - A - P - Q	M - A - P - Q	
Application diagnostics		M	M - A - P	M - A - P - Q	M - A - P - Q	
Diagnostics with location of error source		M	M - A - P	M - A - P - Q	M - A - P - Q	
Debugging and display services		PLC simulator	M	M - A - P	M - A - P - Q	M - A - P - Q
	Hypertext link animations in graphic languages	M	M - A - P	M - A - P - Q	M - A - P - Q	
	Step by step execution, breakpoint	M	M - A - P	M - A - P - Q	M - A - P - Q	
	Watchpoint	M	M - A - P	M - A - P - Q	M - A - P - Q	
	Operator screens	M	M - A - P	M - A - P - Q	M - A - P - Q	
	Diagnostic viewer	M	M - A - P	M - A - P - Q	M - A - P - Q	
Other services	Creation of hyperlinks	M	M - A - P	M - A - P - Q	M - A - P - Q	
	XML import/export	M	M - A - P	M - A - P - Q	M - A - P - Q	
	Application converters (Concept, PL7)		M - A - P	M - A - P - Q	M - A - P - Q	
	Utilities for updating PLC operating systems	M	M - A - P	M - A - P - Q	M - A - P - Q	
	Communication drivers for Windows 2000/XP	M	M - A - P	M - A - P - Q	M - A - P - Q	
	Unity Pro Servers - openness -				M - A - P - Q	
					M - A - P - Q	
UDE support OFS exchanges	Dynamic exchange with 3 rd party tools, OFS				M - A - P - Q	
	Static exchange thru XML/XVM export files	M	M - A - P	M - A - P - Q		

Compatible Modicon platforms	Modicon M340 PLCs M	BMX P34 1000 BMX P34 20●0	BMX P34 1000 BMX P34 20●0	BMX P34 1000 BMX P34 20●0	BMX P34 1000 BMX P34 20●0
	Atrium slot-PLCs A	-	TSX PCI 204M	TSX PCI 204M TSX PCI 354M	TSX PCI 204M TSX PCI 354M
	Premium CPUs P	-	TSX P57 C● 0244/0244M TSX P57 104/1634/154M TSX P57 204/2634/254M TSX H57 24M	TSX P57 C● 0244/0244M TSX P57 104/1634/154M TSX P57 204/2634/254M TSX P57 304/3634/354M TSX P57 4634/454M TSX H57 24/44M	TSX P57 C● 0244/0244M TSX P57 104/1634/154M TSX P57 204/2634/254M TSX P57 304/3634/354M TSX P57 4634/454M TSX P57 5634/554M TSX H57 24/44M
	Quantum CPUs Q	-	-	140 CPU 311 10 140 CPU 434 12U	140 CPU 311 10 140 CPU 434 12U 140 CPU 651 50/60 140 CPU 671 60

Software name	Unity Pro Small	Unity Pro Medium	Unity Pro Large	Unity Pro Extra Large
Unity Pro software type	UNY SPU SF● CD30	UNY SPU MF● CD30	UNY SPU LF● CD30	UNY SPU EF● CD30
Pages	4/29			

EF/EFB function development software in C language	Software for firmware and application loading	Software for designing and generating batch/process applications	SFC View application diagnostic and monitoring software	Pack for developing specific solutions
				
<p>Enhancement of EF and EFB function block libraries:</p> <ul style="list-style-type: none"> □ Creation of families □ Development of functions in C language □ Access to all data and variable types □ Debugging functions (step by step, breakpoint) □ Use of functions created in all languages <p>Supplied with:</p> <ul style="list-style-type: none"> □ Microsoft Visual C++ □ GNU source code and compiler 	<p>Simple and easy to use software to upgrade a Modicon M340 PLC when the user doesn't need to display/modify the program.</p> <p>Upload/download:</p> <ul style="list-style-type: none"> □ CPU and Ethernet module firmware □ PLC project, including: <ul style="list-style-type: none"> - Program - Located and unlocated data - User files and user web pages 	<p>UAG specialist software for designing and generating batch/process applications in a "Collaborative Automation" environment. It provides the unique project database:</p> <ul style="list-style-type: none"> □ process and control (PLCs) □ HMI user interface (Magellis) □ SCADA supervision (Monitor Pro V7.2) <p>Based around re-usable objects (PID, valves, etc) and complying with standard ISA S88, UAG generates the PLC code and the elements required for the HMI system. Complies with the GAMP standard (<i>Good Automation Manufacturing Practice</i>)</p>	<p>ActiveX control component for monitoring and diagnostics of chart status (SFC or Grafcet) in sequential applications:</p> <ul style="list-style-type: none"> □ Overview of charts and detailed views □ Can be integrated in human/machine interface (HMI) applications □ Access to PLC data via OFS (<i>OPC Factory Server</i>) <p>Includes EFB function block library for Unity Pro (for Premium, Atrium and Quantum CPUs)</p>	<p>Specialist software for developing made-to-order solutions (for example interfaces with an electrical CAD system, automatic application generator, etc):</p> <ul style="list-style-type: none"> □ Access to Unity Pro object servers □ Reserved for IT development engineers using Visual Basic or C++
<p>Compatible with:</p> <ul style="list-style-type: none"> □ Unity Pro Small, Medium, Large and Extra Large □ All Modicon M340 PLCs □ All Atrium slot-PLCs □ All Premium Unity CPUs □ All Quantum Unity CPUs 	<p>Compatible with:</p> <ul style="list-style-type: none"> □ Unity Pro Small, Medium, Large and Extra Large □ All Modicon M340 PLCs 	<p>Compatible with:</p> <ul style="list-style-type: none"> □ Unity Pro Extra Large □ TSX P57 4634/454M and TSX P57 5634/554M Premium Unity CPUs □ All Quantum Unity CPUs 	<p>Compatible with:</p> <ul style="list-style-type: none"> □ Unity Pro Extra Large □ All Modicon M340 PLCs □ All Atrium slot-PLCs □ All Premium Unity CPUs □ All Quantum Unity CPUs 	<p>Compatible with:</p> <ul style="list-style-type: none"> □ Unity Pro Extra Large □ All Modicon M340 PLCs □ All Atrium slot-PLCs □ All Premium Unity CPUs □ All Quantum Unity CPUs
<p>Unity EFB Toolkit</p>	<p>Unity Loader</p>	<p>Unity Application Generator</p>	<p>Unity SFC View</p>	<p>Unity Developer's Edition</p>
<p>UNY SPU ZFU CD30E</p>	<p>UNY SMU ZU CD30</p>	<p>UNY SEW LF● CD23</p>	<p>UNY SDU MF● CD20</p>	<p>UNY UDE VFU CD21E</p>
<p>4/33</p>	<p>4/39</p>	<p>–</p>	<p>4/37</p>	<p>4/28</p>

User interface

Unity Pro's main screen provides access to all available tools in a user-friendly format that has been redesigned on the basis of feedback received from users of Concept and PL7 application design software.

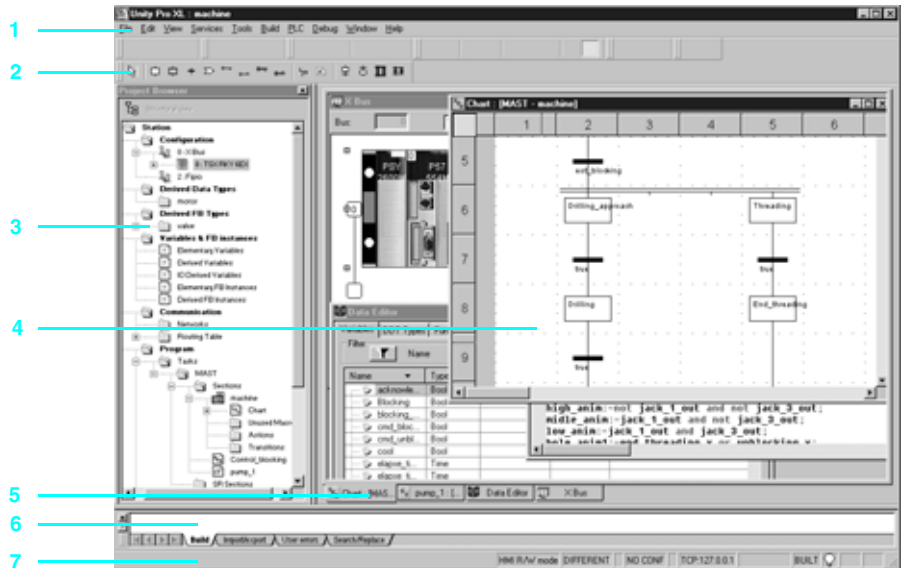

This main screen consists of a general view made up of a number of windows and toolbars, which can be arranged as required on the screen:

- 1 Menu bar from which all functions can be accessed
- 2 Toolbar consisting of icons from which the most frequently used functions can be accessed
- 3 Application browser, which can be used to browse the application based on a conventional and/or a functional view
- 4 Editor windows area, which can be used to view a number of editors at the same time (configuration editor, Structured Text/Ladder etc. language editors, data editor)
- 5 Tabs for direct access to editor windows
- 6 Information window with tabs (User Errors, Import/Export, Search/Replace, etc.)
- 7 Status bar

Accessing functions

All functions can be accessed via drop-down menus from the menu bar. The toolbar, which consists of icons, provides more rapid access to the most frequently used functions. This toolbar, which is displayed by default, can be customized to meet the requirements associated with the various uses of Unity Pro software and is divided into three groups:

- Main toolbars, which are visible at all times
- Contextual toolbar, which is displayed when the corresponding editor is selected
- Toolbar with zoom functions (in and out), full-screen view for editor window

They are classified according to the category of functions available:

- File management (New Project, Open, Save, Print)
- Edit (Undo, Redo, Confirm, Go To)
- Application services (Analyze Project, Build Project, Browse, Find, Access Library)
- Automation platform operating mode (Upload/Download Project, Online/Offline, Run/Stop, Animate, PLC/Simulation Mode)
- Debug mode (Set/Remove Breakpoint, etc.)
- Window display (Cascade, Horizontal, Vertical)
- Online help (non-contextual or contextual)



"File/Edit" toolbar



FBD language editor contextual toolbar



"PLC" toolbar for debug mode



Toolbar with zoom (in and out)

Project browser

The project browser can be used:

- To display the content of a Modicon M340, Atrium, Premium or Quantum PLC project
- To move between the different components of the application (configuration, program, variables, communication, DFB user function blocks, DDT derived function blocks) created by the user

The project can be displayed using two types of view:

■ The **structural view**, which provides an overall view of the various components of the application. This representation provides a view of the order in which the program sections are processed in the PLC.

■ The **functional view**, which provides a view of the project based on specific function modules. This representation provides a breakdown according to consistent functions in relation to the process to be controlled.

These two types of view, which are available at any time, can be displayed separately or at the same time (horizontal or vertical windows) by clicking on the icons in the toolbar.

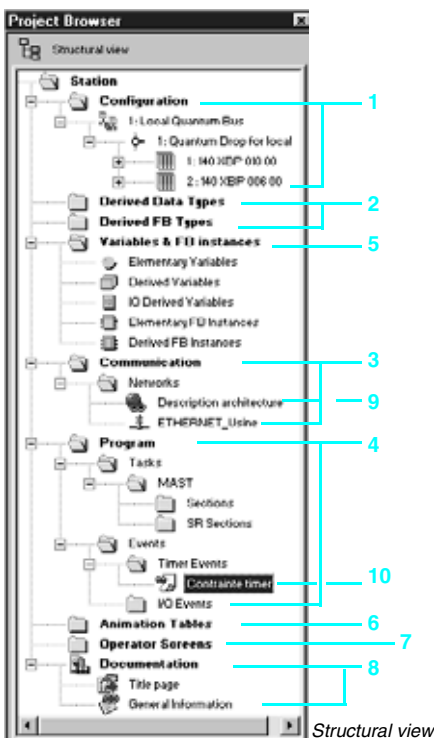

Structural view

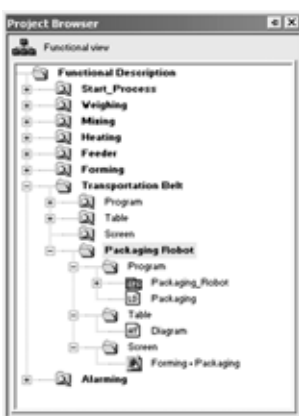

Functional view

Structural view

This conventional view allows you to access all the different components of the application (configuration, programming, function blocks, debugging, etc.) via the application browser.

The browser gives an overall view of the program and offers fast access to all application components.

- 1 Configuration editor
- 2 DFB (user function block) and DDT (Derived Data Type) editors
- 3 Communication networks editor
- 4 Program editor
- 5 Variables editor
- 6 Animation tables editor
- 7 Operator screens editor
- 8 Documentation editor

From any level in the tree structure, you can:

- 9 Create a hyperlink to a comment or description
 - 10 Create a directory for storing hyperlinks used to access a set of user folders
- From this level, it is also possible to zoom in and only view the detailed levels for a component on this level.

Functional view

Unity Pro software applications support the creation of an application structure for Modicon M340, Atrium, Premium and Quantum platforms based on function modules comprising:

- Sections (program code)
- Animation tables
- Runtime screens

The designer can define a multi-level tree structure for the application, independently of the multitask structure of the PLC.

Program sections written in Ladder (LD), Structured Text (ST), Instruction List (IL), Function Block Diagram (FBD) or Sequential Function Chart (SFC) language can be associated with each level, along with animation tables and runtime screens.

Exporting/Importing function modules

All or part of the tree structure can be exported as function modules. In this case, all program sections on the various module levels are exported.

Utilities make it easy to reuse these modules in new applications by means of data and module name reassignment services.

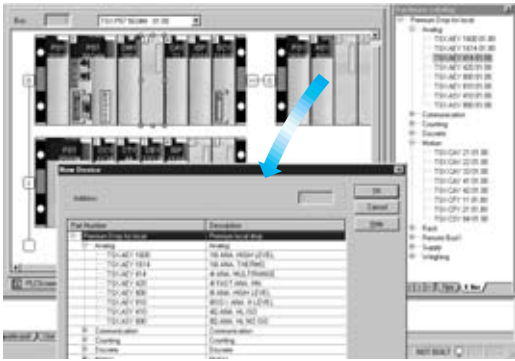

Hardware configuration

Configuration editor

Hardware configuration

The first step when creating an automation project based on a Modicon M340, Atrium, Premium or Quantum platform is to select the processor for which a rack and power supply are defined by default.

The configuration editor supports the intuitive and graphics-based modification and extension of this configuration with the following elements:

- Racks, power supply
- PCMCIA memory or communication cards (Atrium/Premium) on the processor
- Discrete I/O, analog I/O or application-specific modules
- Etc

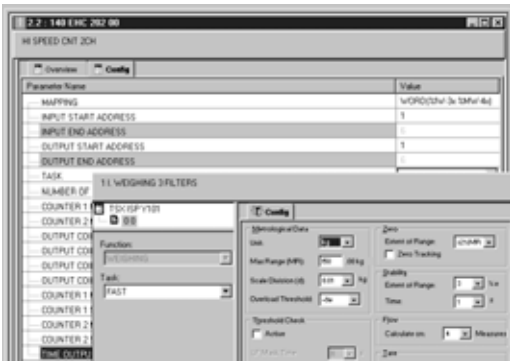

I/O modules parameter setting

Configuration and parameter settings for I/O and application-specific modules

From the configuration screen for Modicon M340, Atrium, Premium or Quantum racks, the parameters screen displayed for the module concerned can be used to define the operating characteristics and parameters for the selected application, e.g.:

- Filter values for discrete I/O
- Voltage or current range for analog I/O
- Threshold counter values
- Trajectory of axes for position control
- Weigher calibration for weighing
- Transmission speed for communication
- Presymbolization for variables associated with modules
- Etc



Communication folder with 2 networks declared

Configuration and parameter settings for communication networks

The "Communication" folder in the structural view can be used to define the list of networks connected to the PLC station. Then, the parameters for all elements required for networks to function correctly can be set by:

- Creating a logical network to which comments can be associated
- Configuring a logical network defining the various associated network services.

Once the network module has been created in the configuration, it must then be associated with one of the logical networks.

Ethernet TCP/IP, Modbus Plus and Fipway network modules are all configured in this way.

4

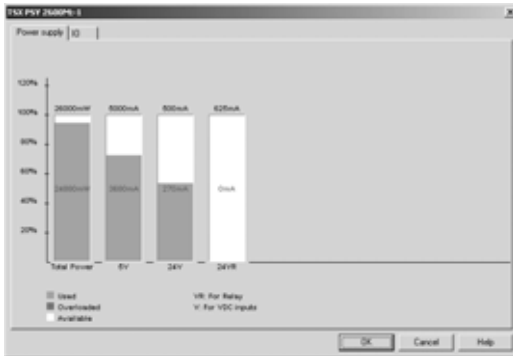

Power supply requirements analysis



Graphical configuration of devices on CANopen bus

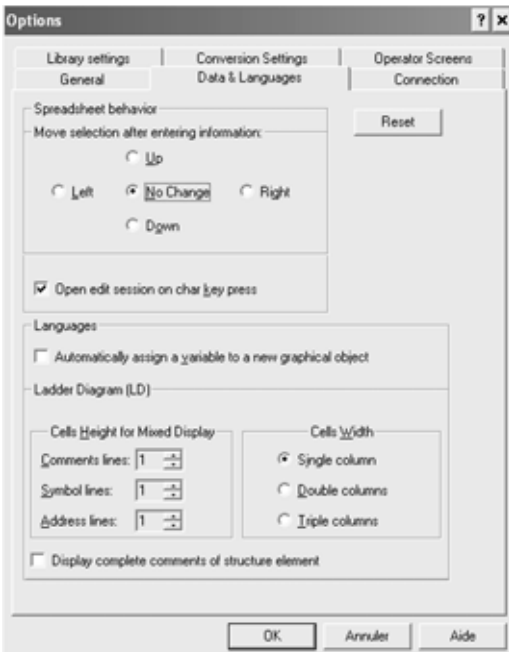

"Data & Languages" tab in the workstation options

Configuration editor (continued)

Configuration check

The following information can be accessed at any time during configuration:

- The power consumption statistics for the power supply in each of the racks in the PLC configuration, for all the different voltages provided by each of these power supplies
- The number of inputs/outputs configured (with a Modicon M340, Atrium or Premium platform)

Configuration of devices on CANopen

In the same way as for in-rack modules, the configuration of devices on CANopen though a Modicon M340 is fully integrated in the configuration editor.

Workstation and project configuration

Unity Pro can be used to configure both the working environment (workstation options) and the content of the project itself.

It is also possible to configure the toolbars and to run third-party applications from Unity Pro.

In addition, users can choose the working language from the list of languages selected when the software was installed.

Workstation options

The workstation options cover all the characteristics specific to a given workstation. They are applied when Unity Pro is used to develop any project on that station.

The following elements can be configured:

- How the data in the project being developed is edited and presented (for example, whether or not coils are positioned in the last column of the editor, or the position of the cursor after confirmation of the data entered)
- The application conversion strategy from PL7, Concept IEC and LL984 language
- The function library path
- The opening mode for Unity Pro: either programming or run mode



"Build" tab in the workstation options

Workstation and project configuration (continued)

Project options

Unlike the workstation options, the project options cover characteristics that have a direct impact on the programming and operating capabilities offered by the program in the PLC. They are saved in the application, and, consequently, are attached to the project. They can be modified during the course of the project.

Project option configuration covers the following elements:

- Building the project with all or part of the data it contains so that it can be retrieved on a new terminal
- Use of diagnostic functions and language for messages
- Warnings generated during project analysis: overlapping of addresses, unused variables etc.
- Language extension: If none of the boxes are checked, the program is strictly compliant with standard IEC 61131-3. Extensions are possible in all five of Unity Pro's languages.
- Access management to runtime screens in online mode

4



User-created toolbar containing all the debugging tools

Other possible options

Users can create their own toolbars by reusing the default icons provided in the toolbars.



Menu for adding and deleting tool access from Unity Pro

It is also possible to enhance Unity Pro's main menu bar by adding direct links to other software tools.

A utility in the Unity Pro program group can be used to change the working language. This is then applied the next time the program is launched. Six languages are available: English, French, German, Italian, Spanish and Chinese.

Software structure

The Modicon M340, Atrium, Premium and Quantum platforms set up by Unity Pro software support two types of application structure:

- **Single-task:** This is the more simple default structure, in which only the master task is executed.
- **Multitask:** This structure, which is more suitable for high-performance real-time events, consists of a master task, a fast task, periodic tasks, and high-priority event-triggered tasks.

The master, fast and periodic tasks are made up of sections and subroutines. The sections and subroutines can be programmed in any of the following languages: Structured Text (ST), Instruction List (IL), Ladder (LD) or Function Block Diagram (FBD). The event-triggered tasks use the same languages. Sequential Function Chart (SFC) or Grafset language is reserved for master task sections.

The table below lists the possible program tasks for Modicon M340, Atrium, Premium and Quantum type processors respectively.

Platform	Modicon M340		Premium			Atrium	Quantum	
	BMX P34 1000	BMX P34 2000	TSX P 57 C 244M TSX P 57 0244M TSX P 57 104M	TSX P 57 20(3)4M TSX P 57 30(3)4M TSX P 57 40(3)4M	TSX P 57 554M TSX P 57 5634M	TSX PCI 57 204 M TSX PCI 57 454 M	140 CPU 31110 140 CPU 434 12U	140 CPU 651 00 140 CPU 671 60
Cyclic or periodic master task	Yes	Yes	Yes	Yes	Yes	Yes	Yes	Yes
Periodic fast task	Yes	Yes	Yes	Yes	Yes	Yes	Yes	Yes
Periodic auxiliary tasks	–	–	–	–	4	–	–	4
Event-triggered tasks								
From modules	32	64	32	64	128	64	64	128
From timers	32	64	–	–	32	–	16	32
Total	32	64	32	64	128	64	64	128

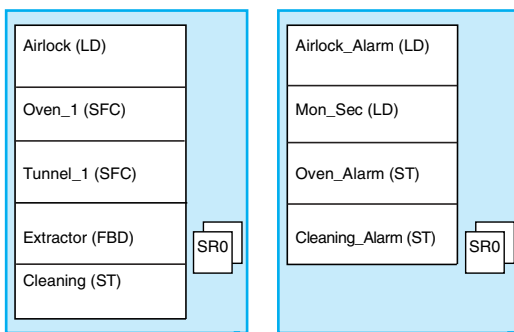

Master task

Fast task

Structure, modular and portable programming

The tasks of a Unity Pro program for Modicon M340, Atrium, Premium or Quantum platforms are composed of several parts known as sections and subroutines. Each of these sections can be programmed in the most appropriate language for the process to be executed.

Such division into sections enables a structured program to be created and program modules to be generated or added with ease.

Subroutines can be called from any section of the task to which they belong or from other subroutines in the same task.

Compatibility of languages compliant with IEC standard 61131-3: Unity Pro software can be configured (*Tools/Project Settings/Language Extensions menu*) to ensure that applications generated are compliant with IEC standard 61131-3.

Furthermore, as long as you use only the standard instruction libraries, you will be able to reuse programs created in this way on any Modicon M340, Atrium, Premium or Quantum platform.

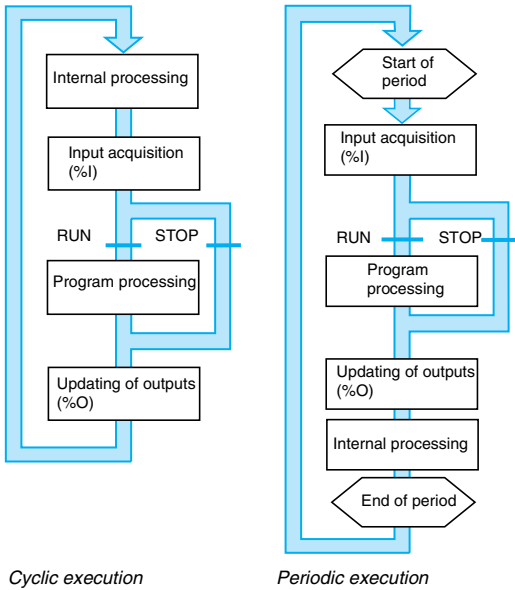

Cyclic execution

Periodic execution

Single-task memory structure

Two types of cyclic execution are supported:

- Normal cyclic execution. This is the default option.
- Periodic execution. This type of execution, as well as the period, are selected by the user during programming when the task parameters are set (master task).

Normal execution (cyclic)

At the end of each scan, the PLC system launches a new scan. The execution time of each scan is monitored by a software watchdog whose value is defined by the user (max. 1500 ms).

In the event of overrun, a fault occurs causing:

- The scan to stop immediately (STOP)
- A fault state to be displayed on the front panel of the processor
- The alarm relay for the main rack power supply to be set to 0

Periodic execution

A new scan is executed at the end of each period. The execution time of the scan must be less than the time of the period defined (max. 255 ms). In the event of overrun, the latter is stored in a system bit (%S19), which can be reset to 0 by the user (via the program or terminal).

A software watchdog, which can be configured by the user (max. 1500 ms), monitors the scan time. In the event of overrun, an execution fault is indicated (see normal execution). The scan execution times (the last scan, the longest scan and the shortest scan) are stored in system words %SW 30/31/32.

Multitask software structure

Modicon M340, Atrium, Premium and Quantum platforms support a multitask structure comprising:

- 1 master task (divided into several sections programmed in ST, IL, LD, FBD, and SFC languages)
- 1 fast task (divided into sections)
- 0 to 4 auxiliary tasks (divided into sections) (1)
- 1 or more event-triggered tasks (only one section per task)

These tasks are independent and are executed in parallel, with the PLC processor managing their execution priority. When an event occurs, or at the start of the fast task scan:

- If any lower-priority tasks are currently being executed, they are suspended.
- The event-triggered task or fast task is executed.
- The interrupted task resumes once execution of the priority task has been completed.

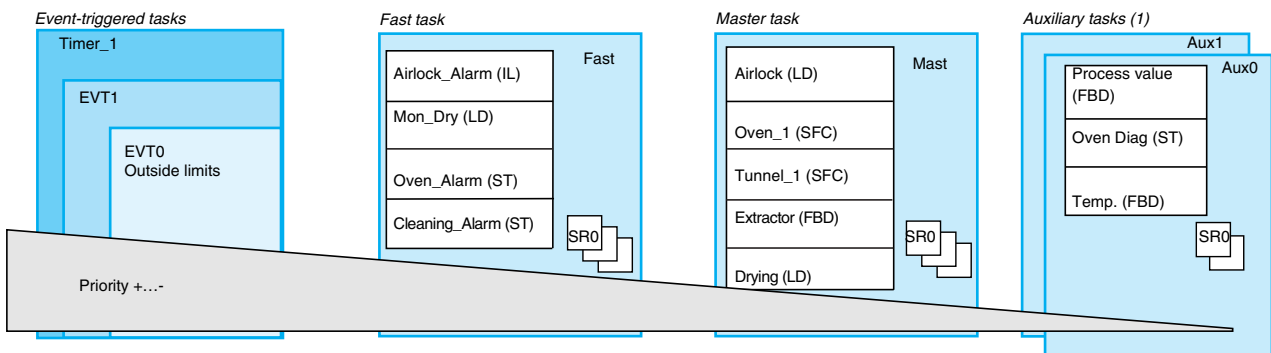

This structure optimizes the way in which processing power is employed and can be used to structure the application and simplify design and debugging, as each task can be written and debugged independently of the others.

(1) Tasks reserved for top-of-the-range Premium TSX P57 5●4M and Quantum 140 CPU 651 ●0/67160 processors.

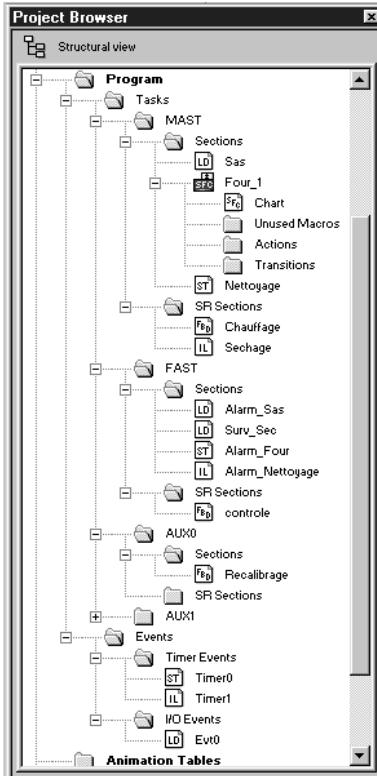

Application browser

Multitask memory structure (continued)

Master task

This task, which can be periodic or cyclic, executes the main program. It is activated systematically.

Each of its component sections and subroutines can be programmed in Ladder (LD), Function Block Diagram (FBD), Structured Text (ST) or Instruction List (IL) language. Several sections of the master task can be programmed in Sequential Function Chart (SFC) or Grafcet language.

Fast task

This task, which has a higher priority than the master task, is periodic in order to allow time for tasks with lower priorities to be executed. It should be used when fast periodic changes in discrete inputs need to be monitored and acknowledged.

The execution of the master task (lower priority) is suspended while the fast task is being executed. Processing operations in this task must be as short as possible in order to avoid adversely affecting master task processing operations.

Each of the component sections and subroutines of the fast task can be programmed in Instruction List, Structured Text, Ladder or Function Block Diagram language (ST, IL, LD or FBD).

Auxiliary tasks

These tasks, which are available on top-of-the-range Premium TSX P57 5●4M and Quantum 140 CPU 651 ●0/67160 processors, are designed for use with slower types of processing operation such as measurement, process control, HMI, application diagnostics, etc.

Periodic type auxiliary tasks have the lowest level of priority and are executed once the higher-priority periodic tasks (master and fast) have completed their scan.

Each of the component sections and subroutines of the fast task can be programmed in Instruction List, Structured Text, Ladder or Function Block Diagram language (ST, IL, LD or FBD).

Event-triggered tasks

Unlike the tasks described above, these tasks are not linked to one period. The execution of these tasks is triggered asynchronously by:

An event from certain application-specific modules (e.g.: overrun of a counter threshold, change of state of a discrete input)

An event from the event timers

These tasks are processed before all other tasks and are thus suitable for processing requiring very short reaction times in comparison to the arrival of the event.

Modicon M340, Atrium, Premium or Quantum platforms have 3 levels of priority (these are, in descending order, module event EVT0, module events EVTi and timer events Timeri).

These tasks, each comprised of a single section, can be programmed in Instruction List, Structured Text, Ladder or Function Block Diagram language (ST, IL, LD or FBD).

Assignment of I/O channels to tasks

Each of the master, fast or event-triggered tasks reads (at the start of the scan) and writes (at the end of the scan) the inputs assigned to it. By default, they are assigned to the master task.

For the Quantum platform, the remote inputs/outputs (RIO) are only assigned to the master task (these assignments can be made per station or for each of the component sections of the task), while the distributed inputs/outputs (DIO) are all assigned to the master task (without assignment to its component sections).

For event-triggered tasks, it is possible to assign input/output channels (1) other than those relating to the event. Exchanges are then performed implicitly at the start of processing for inputs and at the end of processing for outputs.

(1) These channel assignments are made per I/O module for Quantum and per channel for Atrium/Premium inputs/outputs.

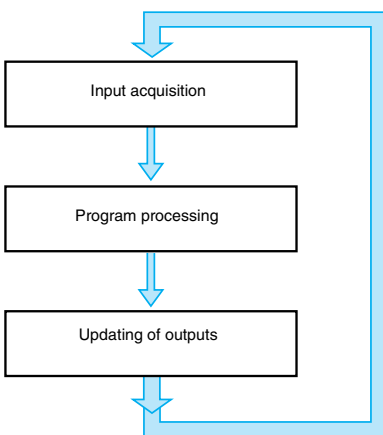

Program execution

The five IEC languages

The five graphical or textual languages available in Unity Pro are used for programming Modicon M340, Atrium, Premium and Quantum automation platforms.

The 3 graphical languages are:

- Ladder (LD)
- Function Block Diagram (FBD)
- Sequential Function Chart (SFC) or Grafcet

The 2 textual languages are:

- Structured Text (ST)
- Instruction List (IL)

For these 5 languages, you can use the standard set of instructions compliant with IEC standard 61131-3 to create applications, which can be transferred from one platform to another. Unity Pro software also provides extensions to this standard set of instructions. When they are specific to Modicon M340, Atrium/Premium and Quantum PLCs, these extensions support the development of more complex applications in order to maximize the potential of the specific features of each of these platforms.

Functionalities common to all five language editors

The editors for each of the 5 languages provide a number of common tools used for writing, reading and analyzing programs in a user-friendly manner:

- The text editors for Instruction List (IL) and Structured Text (ST) support:
 - Text entry in insert or overwrite mode
 - The use of dialog boxes for the assisted entry of variables, functions, function blocks or assignment instructions
 - Checks on data entry to detect syntax or semantics errors. The user is informed of the result of this check by red “wavy” underlining or by a change in the color of the text concerned.
 - Access to a set of colors, which can be used to facilitate reading by distinguishing text (black) from operators (red), language key words (blue), and program comments (green)
- The graphics editors for Ladder (LD) language, Function Block Diagram (FBD) language and Sequential Function Chart (SFC) language feature:
 - A set of graphic elements for direct access to the various graphic symbols in the language via the mouse or keyboard
 - A pop-up menu, which can be accessed by right-clicking with the mouse
- Unlimited number and length of comments. These comments can be positioned as text objects in any cell (graphical languages) or at any point in expressions (textual languages).
- Assisted data entry functions for:
 - Accessing DFB function libraries, the variables editor or the text object for entering comments
 - Initializing a variable reference
 - Initializing the animation table on selected variables
 - Displaying and modifying the properties of the selected variable
 - Creating variables in real time without having to use the data editor
- “Cut”, “Copy”, “Paste”, “Delete”, “Move”, etc.
- Setting bookmarks on lines of text or in the margin so that you can:
 - Easily locate lines in important program sections
 - Browse in an editor by bookmark, label or line and column number

Ladder (LD) language

Each section or subroutine using Ladder language consists of a series of rungs, which are executed sequentially by the PLC. Each rung consists of graphic objects (placed in cells arranged in columns and lines) corresponding to contacts, links, coils, operation blocks, EF/EFB/DFB function blocks, jumps, SR calls, etc.

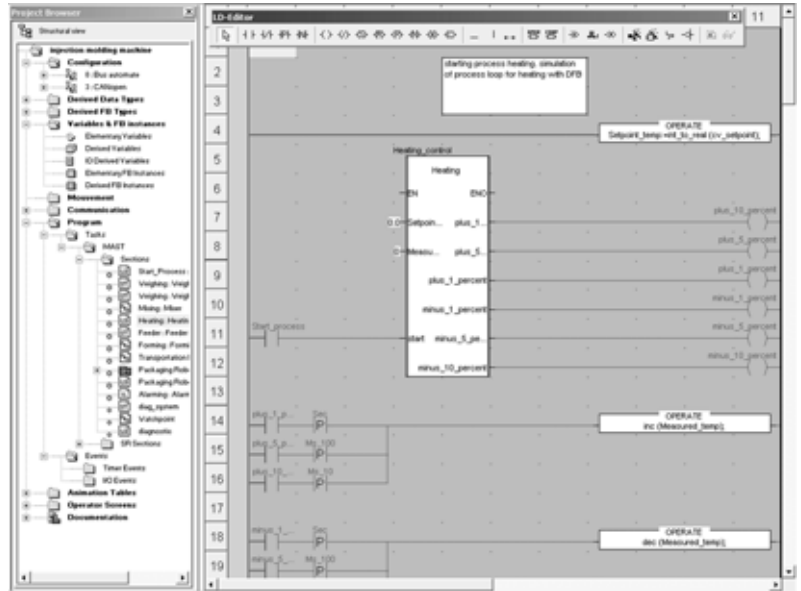

Program structure (section or subroutine)

Each Ladder language section may contain:

- Between 11 and 64 columns (number set by user)
- Up to 2000 lines (for all rungs in the section)



Graphics palette in the Ladder language editor

“Mixed Display” mode supports the unrestricted display of comments, addresses and symbols for the variables used for rungs.

4

Function Block Diagram (FBD) language

Function Block Diagram language is a graphical language based on function blocks associated with variables or parameters, which are linked together. This language is particularly suitable for process control applications.

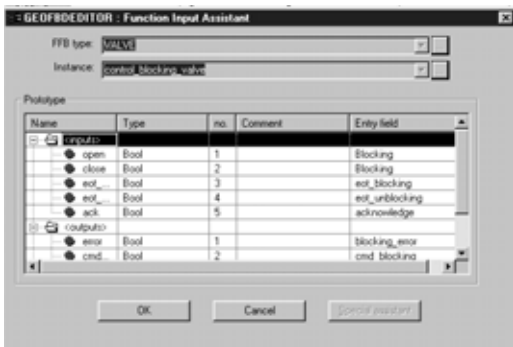
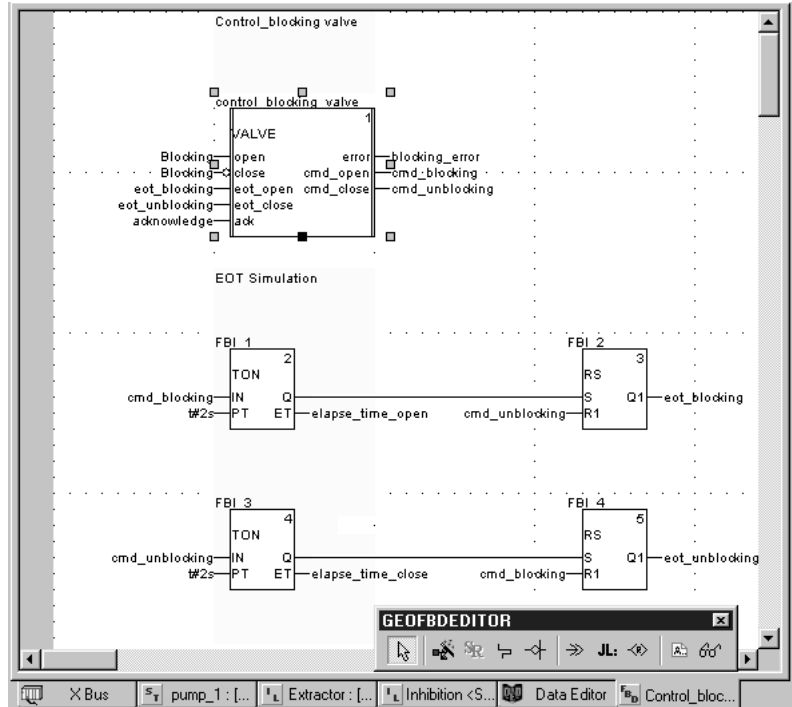

Function Block Assistant

Program structure (section or subroutine)

The graphical language FBD supports three types of function blocks:

- Elementary blocks (EFs)
- Elementary Function Blocks (EFBs), sorted into different libraries depending on their type of use
- Derived Function Blocks (DFBs), which have a structure identical to that of EFBs but are created by the user with the ST, IL, LD or FBD programming languages

Within the same section, subroutines can be called using a specific block. Program jumps to a block instance can also be programmed.

A section programmed in FBD language contains the equivalent of a default grid with 30 columns and 23 rows. This can be extended to a wider page.

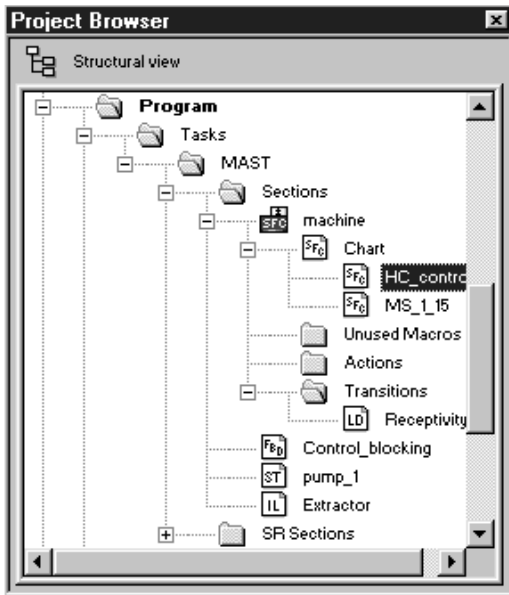

SFC structure in the browser

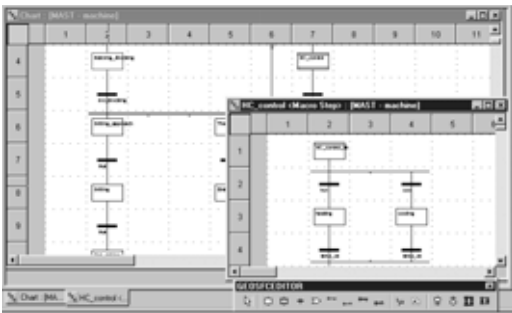

SFC chart

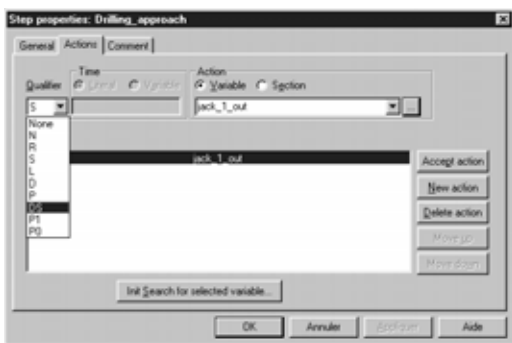

Step properties

Sequential Function Chart (SFC) and Grafcet language

Sequential Function Chart (and Grafcet) language can be used to describe the sequential part of an automation system in simple graphical format using steps and transitions.

SFC language does not process charts in the same way as Grafcet language:

- SFC only authorizes one token in one chart.
- Grafcet language authorizes several tokens in one chart.

Unity Pro software has one editor for these two languages with the option of defining behavior in the application settings (*Tools/Project Settings/Language Extensions menu*).

Program structure (master task section)

SFC language is only used in sections belonging to the master task. Each SFC section consists of a main chart sub-section CHART and sub-sections for each of the macro-steps. The component parts of the charts are:

- Macro-steps, which are the sole representation of a set of steps and transitions (used to set up a hierarchical chart structure)

- Steps

- Transitions and directed links between steps and transitions

Associated with steps and transitions respectively, the actions and transition conditions can be:

- Integrated into the CHART or macro-step charts, in which case the actions or transition conditions are defined by a single variable
- Processed in specific sections, in which case dedicated processing (to be programmed in Ladder, Function Block Diagram, Structured Text or Instruction List language) is necessary

In order to check that machine scans have been completed successfully, activity times (minimum, maximum) can be associated with each step. These times are set by the user.

Program structure (section in master task)

For each SFC section, the graphics editor provides a maximum of:

- One grid containing 32 columns and 200 rows, or 6400 cells. Steps, transitions or jumps all need one cell respectively.
- 1024 steps (macro-steps and steps in macro-steps)
- 20 actions assigned to the same step
- 100 steps activated at the same time
- 100 actions activated at the same time

To help you to create basic charts, graphic screens can be used to create “n” steps in series and “m” steps in parallel in a single operation.

Dialog boxes can be used to assign associated properties to steps (activity time, actions), transitions (variable linked to transition condition), etc.

Structured Text (ST) language

Structured Text language is a sophisticated algorithmic type language, which is particularly suitable for programming complex arithmetic functions, table operations, message handling, etc.

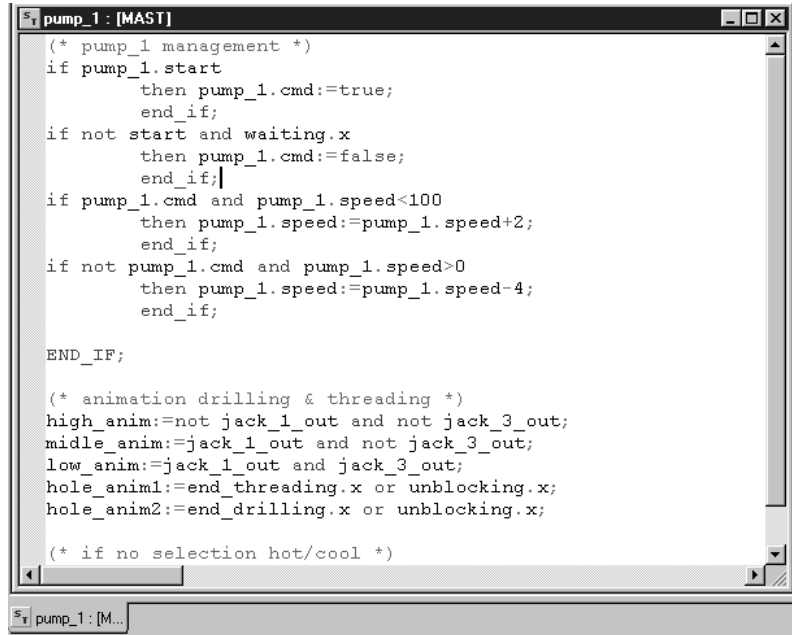

```

pump_1 : [MAST]
(* pump_1 management *)
if pump_1.start
  then pump_1.cmd:=true;
  end_if;
if not start and waiting.x
  then pump_1.cmd:=false;
  end_if;
if pump_1.cmd and pump_1.speed<100
  then pump_1.speed:=pump_1.speed+2;
  end_if;
if not pump_1.cmd and pump_1.speed>0
  then pump_1.speed:=pump_1.speed-4;
  end_if;

END_IF;

(* animation drilling & threading *)
high_anim:=not jack_1_out and not jack_3_out;
middle_anim:=jack_1_out and not jack_3_out;
low_anim:=jack_1_out and jack_3_out;
hole_anim1:=end_threading.x or unblocking.x;
hole_anim2:=end_drilling.x or unblocking.x;

(* if no selection hot/cool *)

```

Program structure (section or subroutine)

Structured Text language, which can be used to directly transcribe an analysis based on an organization chart, is structured into expressions composed of a series of instructions organized in lines.

There is no limit to the number of characters an instruction line may contain (the only limit is the program memory available for the Modicon M340, Premium and Quantum platforms, except on TSX P57 10...40 processors, where the limit is 64 Kb). The length of the section is only limited by the size of the application memory.

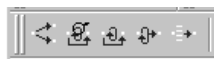

Four preformatted expression structures can be called up directly from the toolbar:

- **Conditional action** : *IF...THEN...ELSIF...THEN...ELSE...END-IF*;
- **Iterative conditional action**: *WHILE...DO...END_WHILE*;
REPEAT...UNTIL...END_REPEAT;
- **Repetitive action**: *FOR...TO...BY...DO...END_FOR*;
- **Selective action**: *CASE...OF...ELSE...END_CASE*;

The operands used in the expressions are bit variables, word variables or variables linked to function blocks.

To make the expressions easier to read, different colors are used to identify objects, language key words and program comments.

Instruction List (IL) language

Instruction List language is a language representing the equivalent of a Ladder diagram in text form. It can be used to write Boolean and arithmetic equations using all the functions available in the Unity Pro language (calling of functions and function blocks, assignment of variables, creation of program jumps, branching to subroutines within a program section, etc.).

```

(* Simple example *)
LD t#5s
ST delay

(* fault motor *)
LD overspeed
AND hot_temp
ST fault_motor

(* Start the motor after delay (in seconds) *)
CAL MOTOR_TIMER (PT := Delay, IN := start_motor)
LD motor_timer.q
ST motor_run

(* Stop the motor after ten seconds in running *)
cal stop_timer(motor_run,t#10s)
LDN stop_timer.q
ST start_motor
  
```

The screenshot shows a window titled 'pump_1 : [...]' with a toolbar containing icons for 'Extractor : [...]', 'Inhibition <S...', 'Data Editor', and 'X Bus'. The code is displayed in a monospaced font within a scrollable area.

Program structure (section or subroutine)

A program in Instruction List language comprises a sequence of instructions classified into the following different families:

- Bit instructions, e.g. read input: *LD overspeed*
- Function block instructions, e.g. call timer: *CAL MOTOR_TIMER*
- Numerical instructions using single, double and floating point integers, e.g.: *LD Result ADD Surplus ST Archive*
- Word table or character string instructions, e.g. make assignment: *LD Result:10:=Setpoint:10*
- Program instructions, e.g. SR call: *CALL SR10*

The operands used in the expressions are bit variables, word variables or variables linked to function blocks.

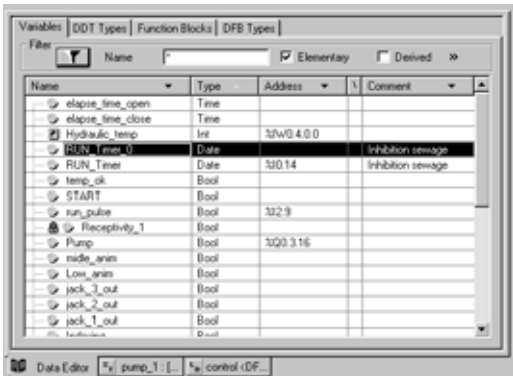

Data editor

Data editor

The data editor, which can be accessed from the structural view of the project, provides a single tool for performing the following editing tasks:

- Declaration of data including variables and function blocks (declaration of their type, instants and attributes)
- Use and archiving of function block data types in different libraries
- Hierarchical view of data structures
- Searching, sorting and filtering of data
- Creation of a hyperlink to access a description from any variable comment

The data is displayed under four tabs:

- “Variables” tab for the creation and management of the following data instances: bits, words, double words, inputs/outputs, tables, and structures
- “DDT Types” tab for the creation of derived data types (tables and structures)
- “Function Blocks” tabs for the declaration of EFB and DFB function blocks
- “DFB Types” for the creation of DFB user function block data types



Variable attributes

Each data instance has several attributes, of which:

- The name and type of the variable are mandatory
- The comment, physical address in the memory or initial values are optional

The data editor columns can be configured (number of columns, order). All the attributes associated with a variable can be displayed in a properties window.

This editor can be accessed at any time during programming by selecting variables for data modification or creation.

4

DFB user function blocks

The user can create his own function blocks for specific application requirements on Modicon M340, Atrium, Premium and Quantum platforms using Unity Pro software. Once created and saved in the library, these user function blocks can be reused as easily as EFBs (Elementary Function Blocks).

These user function blocks can be used to structure an application. They are used when a program sequence is repeated several times in the application or for fixing a standard programming routine. They can be read-only protected or read/write-protected. They can be exported to all other Unity Pro applications.

Using a DFB function block in one or more applications:

- Simplifies program design and entry
- Improves program readability and understanding
- Facilitates program debugging (all variables handled by the DFB block function are identified in the data editor)
- Enables the use of private variables specific to the DFBs, which are independent of the application

A DFB function block is set up in several phases:

- The DFB is designed by assigning a name, a set of parameters (inputs, outputs, public and private internal variables) and a comment to it via the data editor.
- The code is created in one or more sections of the program, with the following languages selected according to requirements: Structured Text, Instruction List, Ladder or Function Block Diagram (ST, IL, LD or FBD).
- The DFB may be stored in a library with an associated version number.
- A DFB instance is created in the data editor or when the function is called in the program editor.
- This instance is used in the program in the same way as an EFB (Elementary Function Block). (The instance can be created from within the program.)

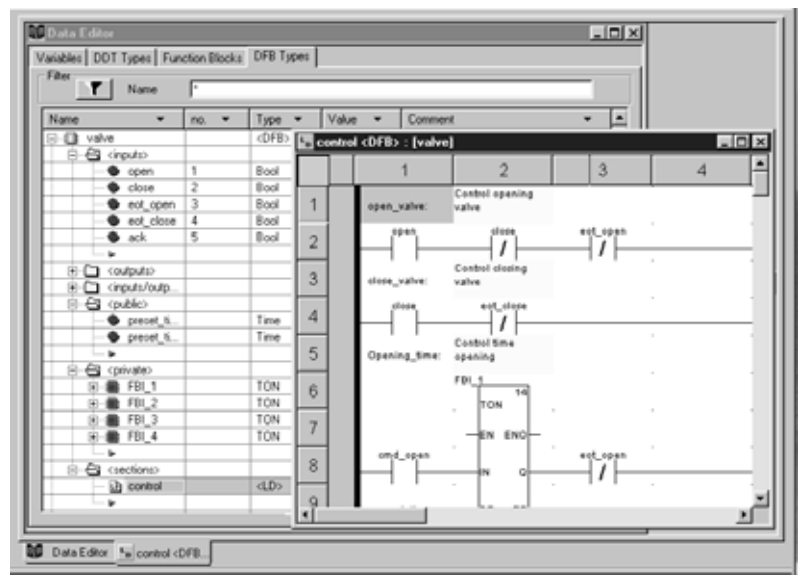

Main characteristics

Inputs	32 max. (1)
Outputs	32 max. (2)
Inputs/outputs	32 max. (1) (2)
Public internal variables	Unlimited (3), can be accessed via the application program
Private internal variables	Unlimited (3), cannot be accessed via the application program
Comment	1024 characters max.
Program sections	Unlimited, each section can be programmed independently in one of the 4 languages (IL, ST, LD, and FBD).

(1) The maximum cumulative total of inputs and inputs/outputs is 32.

(2) The maximum cumulative total of outputs and inputs/outputs is 32.

(3) For Premium processors, see page 1/9: characteristics of memories, maximal sizes of objects zones, internal unlocated data, DFB & EFB function blocks.



Type library manager

Function block libraries

The function and function block libraries manager contains all the elements provided with Unity Pro software. The functions and function blocks are organized into libraries, which themselves consist of families. Depending on the type of PLC selected and the model of processor, the user will have a sub-set of these libraries available to write his/her applications. However, the “Base Lib” library contains a set of functions and function blocks, the majority of which are compatible with all platforms. In particular, it contains the blocks compliant with IEC 61131-3. The “Base Lib” library is structured into families:

- Timers and counters
- Internal process control
- Array management
- Comparison
- Date and time management
- Logic processing
- Mathematical processing
- Statistical processing
- Character string processing
- Type-to-type data conversion

The “Base Lib” library, which covers standard automation functions, is supplemented by others, more application-specific libraries, and some platform-specific functions:

- **Communication library**, providing an easy means of integrating communication programs from PLCs with those used by HMIs from the PLC application program. Like other function blocks, these EFBs can be used in all languages to exchange data between PLCs or to deliver data to be displayed on an HMI.
- **Process control library**. The CONT_CTL library can be used to set up process-specific control loops. In particular, it offers controller, derivative and integral control functions. CONT_CTL comes with other families, providing additional algorithms, e.g.: EFBs for calculating mean values, selecting a maximum value, detecting edges or assigning a hysteresis to process variables, etc.
- **Diagnostics library**, which can be used to monitor actuators and contains EFBs for active diagnostics, reactive diagnostics, interlocking diagnostics, permanent process condition diagnostics, dynamic diagnostics, monitoring of signal groups, etc.
- **I/O management library**, providing services to handle information exchanged with hardware modules (formatting data, scaling...)
- **Motion Function Blocks library** containing a set of predefined functions and data structures to manage motion on drives and servo drives connected on CANopen.
- **Motion library** for motion control and fast counting
- **“System” library**, which provides EFBs for the execution of system functions: evaluation of scan time, availability of several different system clocks, SFC section monitoring, display of system state, etc. In addition, management of files inside the Modicon M340 memory cartridge.
- Finally, a library named “obsolete” containing all function blocks used by legacy programming software that are needed to perform application conversions

Management of user standards

Users may create libraries and families in order to store their own DFB function blocks and DDT data structures. This enhancement allows users to take advantage of programming standards adapted to their needs, along with version management. This means that it is possible to:

- Check the version of the elements used in an application program against those stored in the library
- Perform an upgrade, if necessary

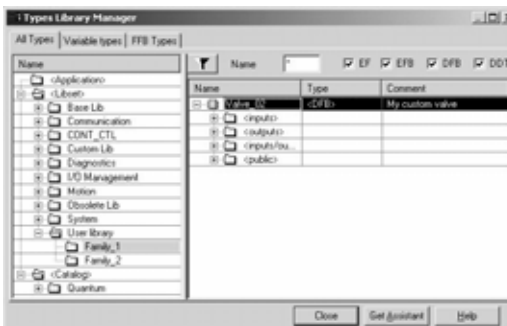

User-defined library manager



Insertion/removal of watchpoint

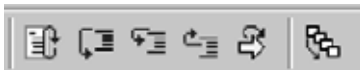

Execution: step-by-step command

```

Secure: [MAST]
IF Niveau_1 >= 600 THEN Pompe_1 := False;
END_IF;
IF Niveau_2 >= 200 Then Pompe_2 := False;
END_IF;
IF Niveau_3 >= 400 Then Vanne_1 := False;
Vanne_2 := False;
END_IF;
IF Boite = 10 Then Vanne_3 := False;
End_IF;
IF Niveau_3 < 80 Then Chauff_on := False;
:= False;
    
```

Animation of ST program

Debugging tools

Unity Pro software offers a complete set of tools for debugging Modicon M340, Atrium, Premium or Quantum applications. A tool palette provides direct access to the main functions:

- Dynamic program animation
- Setting of watchdogs or breakpoints (not authorized in event-triggered tasks)
- Step-by-step program execution. A function in this mode enables section-by-section execution. Instruction-by-instruction execution can be launched from the previous breakpoint. Three execution commands are therefore possible when the element to be processed is a subroutine (SR) or DFB user block:
 - Detailed step-by-step or “Step Into”. This command is used to move to the first element of the SR or DFB.
 - Overall step-by-step or “Step Over”. This command is used to process the entire SR or DFB.
 - Outgoing step-by-step or “Step Out”. This command is used to move to the next instruction after the SR or DFB element.
- Independent execution of the master (MAST), fast (FAST), auxiliary (AUX), and event-triggered (EVTi) tasks.

Animation of program elements

Dynamic animation is managed section by section. A button in the toolbar is used to activate or deactivate animation for each section.

When the PLC is in RUN, this mode can be used to view, simultaneously:

- The animation of a program section, regardless of the language used
- The variables window containing the application objects created automatically from the section viewed

Several windows can be displayed and animated simultaneously. The “Tool tip” function, which uses help balloons, can be used to view a variable and its content simultaneously when the object is selected with the mouse (or other pointing device). The user can add inspect windows to display variables inside the program.

Two types of animation are supported:

- Standard: The variables of the active section are refreshed at the end of the master task (MAST).
- Synchronized: The watchpoint can be used to synchronize the display of animated variables with a program element in order to determine their value at this precise point in the program.

Name	Value	Type	Comment
Initial	0	Bool	
Niveau_1	420	Int	
Niveau_2	0	Int	
Niveau_3	333	Int	
Boite	0	Int	
Quantite_a_pr...	0	Int	
Quantite_prod...	0	Int	
Pompe_1	1	Bool	
Melange_2	0	Bool	

Animation table

Animation table

Tables containing the variables of the application to be monitored or modified can be created by data entry or initialized automatically from the selected program section. In addition to data animation it is possible to:

- Modify bit variables or force them to 0 or 1
- Change the display format
- Copy or move variables
- Search by cross-reference
- Display the list of forced bits

These tables can be stored in the application and retrieved from there at a later date.

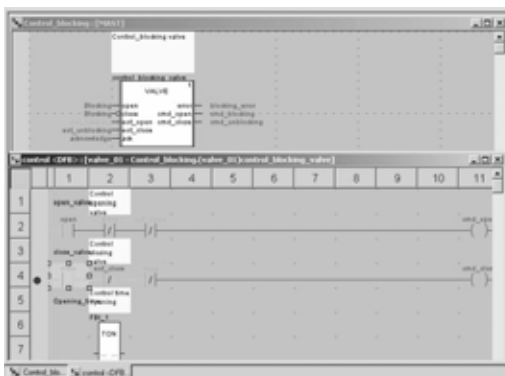

Animation of a DFB program

Debugging of DFB user function blocks

The parameters and public variables of these blocks are displayed and animated in real time using animation tables, with the possibility of modifying and forcing the required objects.

In exactly the same way as with other program elements, the watchpoint, breakpoint, step-by-step execution, and program code diagnostics functions can be used to analyze the behavior of DFBs. Setting a breakpoint in a DFB user function block instance stops the execution of the task containing this block.



SFC control panel

Debugging in Sequential Function Chart (SFC) language

The various debugging tools are also available in SFC language. However, unlike other sections (IL, ST, LD or FBD) an SFC section executed step by step does not stop execution of the task but instead freezes the SFC chart. Several breakpoints can be declared simultaneously within a single SFC section.

Numerous commands are available in this debugging mode via the control panel:

- Deactivate active step(s)
- Activate initial step(s)
- Disable step execution times
- Freeze chart regardless of transition conditions
- Stop processing of steps
- Move to the next step taking account of the transition conditions
- Enable transition and move to next step(s) (detailed step-by-step command, "Step Into")
- Enable transition in order to execute the end of the macro-step (outgoing step-by-step command, "Step Out")
- Preposition chart on steps for which markers have been set, etc.

4

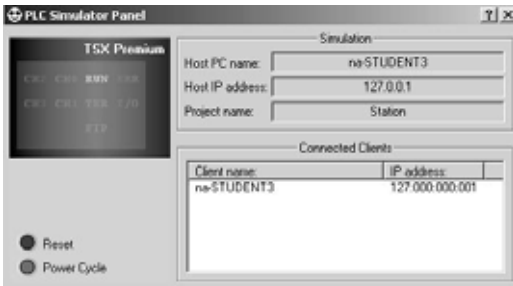

Simulator control panel

PLC simulator

The simulator integrated in Unity Pro can be used to test the application program for Modicon M340, Atrium, Premium or Quantum PLCs from the PC terminal without having to connect to the PLC processor. The functions provided by the debugging tools are available for debugging the master, fast and auxiliary tasks.

As the simulator does not manage the PLC I/O, animation tables can be used to simulate the state of inputs by forcing them to 0 or 1.

The simulator can be connected to third-party applications via an OPC server with OFS (OPC Factory Server) software.

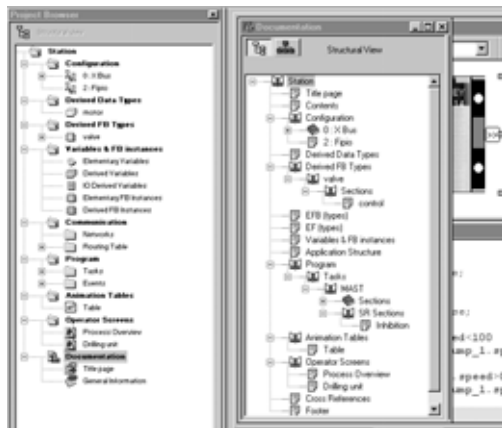

Access to documentation editor

Documentation editor

The documentation editor is built around the Documentation Browser, which shows the file structure in tree form.

It allows all or part of the application file to be printed on any graphics printer accessible under Windows and using True Type technology, in A4 or US letter print format.

The documentation editor supports the creation of user-specific documentation files using the following headings:

- Title page
- Contents
- General information
- Title block
- Configuration
- EF, EFB and DFB type function blocks
- User variables
- Communication
- Project structure
- Program
- Animation tables and cross-references
- Runtime screens

The documentation editor can generate the documentation file based on two different structures:

- Structural view: All the objects in the project are associated with their corresponding headings.
- Functional view: The objects in the project are associated with the function modules to which they belong.

The documentation file can be created and saved as the project progresses, from one Unity Pro session to another.

Modicon M340 automation platform

Unity Pro software
Integrated diagnostics

Presentation

Diagnostics integrated into Modicon M340, Atrium, Premium and Quantum automation platforms

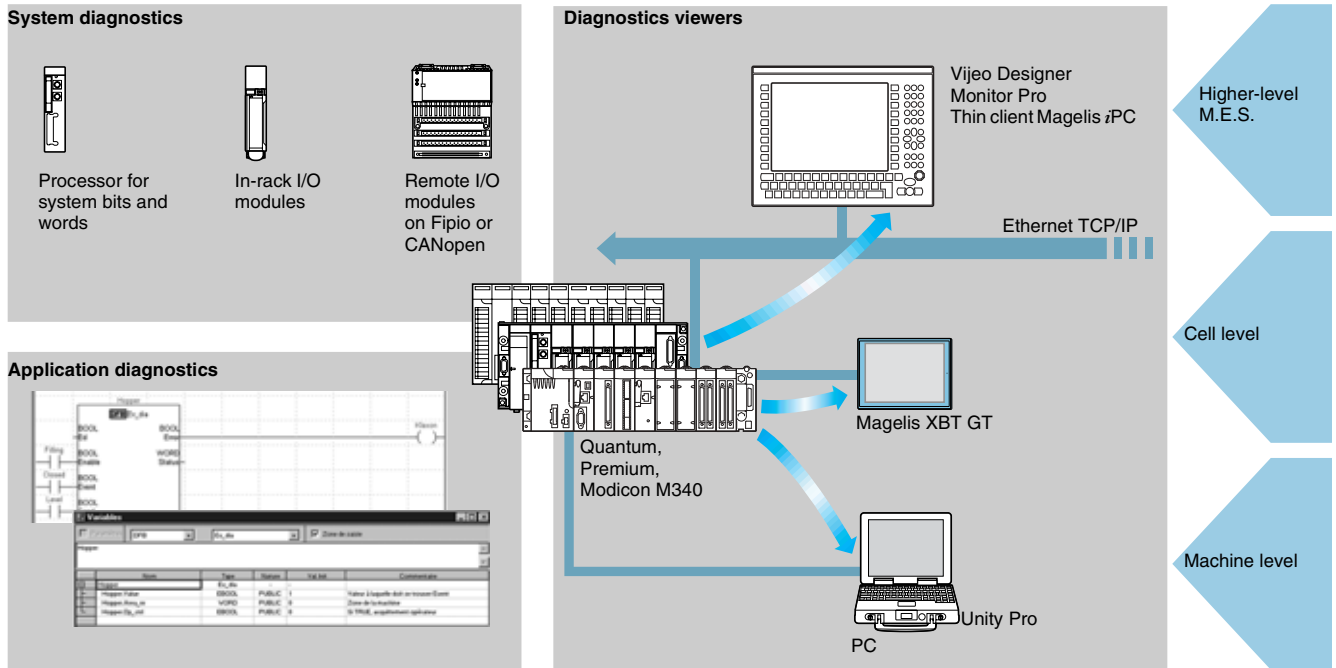

The diagnostics offer for Modicon M340, Atrium, Premium and Quantum platforms is based on three components:

- System diagnostics
- DFB and EFB diagnostic function blocks (for system and application diagnostics)
- Error message display system or viewers supplied as standard with Magelis XBT GT and iPC terminals, Vijeo Designer/Monitor Pro supervisory software and Unity Pro setup software.

Functions

System diagnostics

The system diagnostics for the Modicon M340, Atrium, Premium and Quantum platforms supports the monitoring of system bits/words, I/O modules and activity times (minimum/maximum) of SFC steps. By simply choosing the relevant option in the application configuration, any event will result in time-stamped messages logged inside the diagnostic buffer in the PLC. These events are displayed on a diagnostics viewer (1) automatically without the need of any additional programming.

With the assistance of Unity Pro's integrated diagnostics, this function can be used to perform 1st level diagnostics of the elements in the configuration, up to and including each I/O module channel.

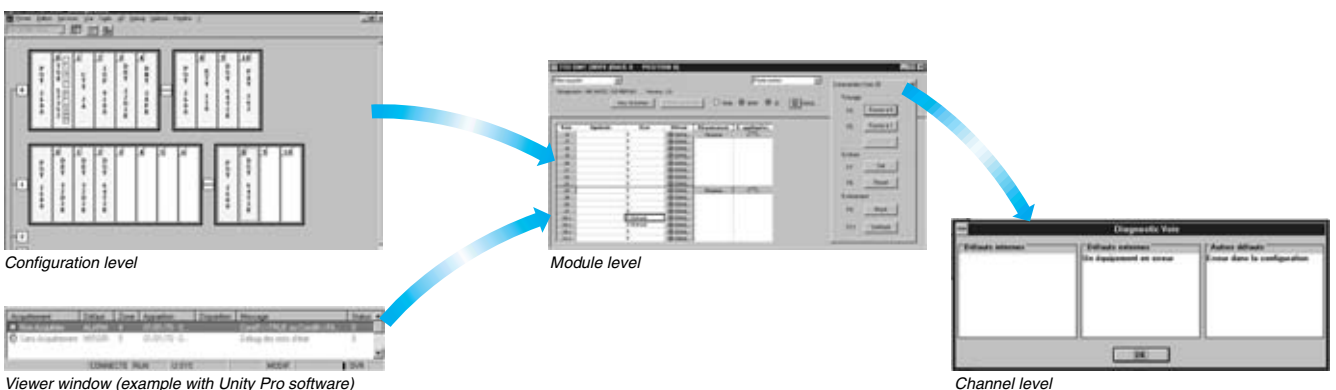

(1) Diagnostics viewers are tools used to display and acknowledge error messages relating to diagnostics. They are supplied as standard with Unity Pro, Vijeo Designer and Monitor Pro software, with Magelis terminals, and with the PLC web server which is accessible through a thin client Magelis iPC.

Modicon M340 automation platform

Unity Pro software

Integrated diagnostics



Application diagnostics

Unity Pro software also has a library of function blocks for monitoring, called diagnostic DFBs and EFBs. The library of diagnostic function blocks contains:

■ Manufacturer blocks for system diagnostics

- IO_DIA input/output fault, which is used to monitor the state of inputs/outputs.
- ASI_DIA, which monitors whether an error has occurred on the AS-i bus (module or bus fault, no slave, slave not configured or faulty).

■ Manufacturer blocks for application diagnostics, for example:

- EV_DIA, which monitors whether an event (bit status) has the correct value at a given time (no notion of timing).
- MV_DIA, D_GRP, D_REA, which monitor whether an event (change in the status of a bit) occurs in accordance with the specified time conditions.
- ALRM_DIA, which monitors the combination of the status of 2 bits.
- NEPO_DIA and TEPO_DIA, which can be used to check, control and perform diagnostics for elements in the working part of the system made up of the combination of 2 actuators and 2 sensors.

■ Open diagnostics blocks

These enable users to create their own diagnostic function blocks to meet the specific requirements of their applications and therefore to supplement the manufacturer DFBs and EFBs described above. They can be created from 2 model blocks, which must be written in Ladder (LD), Structured Text (ST), Function Block Diagram (FBD) or Instruction List (IL) language.

Diagnosics with fault cause analysis

Furthermore, when a fault occurs, Unity Pro analyzes the program sections concerned and opens a second window displaying the causes and probable sources of the fault.

The user or process operator is guided through the fault-finding process, enabling machine downtimes to be reduced.

The configuration module or instruction, which is the source of the fault, can also be accessed via the diagnostics viewer integrated into Unity Pro, directly from the alarm in the viewer output window (see page 4/23).

4

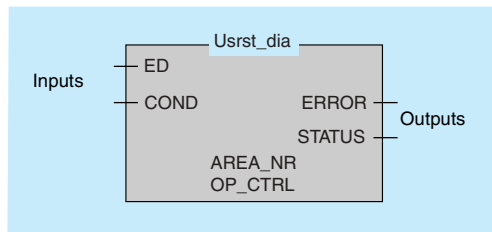

Fault cause analysis

Modicon M340 automation platform

Unity Pro software

Integrated diagnostics

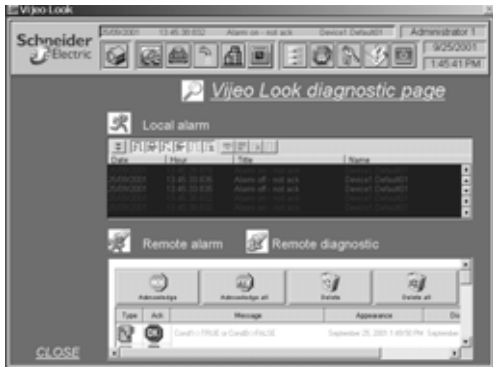

Diagnostics viewers

All the diagnostic events processed by Modicon M340, Atrium, Premium and Quantum platforms via diagnostic DFBs/EFBs are stored in a buffer (specific data memory area on the PLC). The information contained in this buffer is sent (transparently for the user) to viewers for automatic display and for management of faults and alarms. The viewer function is supplied as standard with:

- Vijeo Look and Monitor Pro V7 supervisory software
- Unity Pro programming software
- Magelis XBT GT and Magelis iPC HMI terminals

The viewer integrated in Unity Pro can also be used to access the instruction or module, which is the source of the fault. See “Diagnostics with fault cause analysis”, page 4/22.

Modicon M340, Atrium, Premium and Quantum platforms have multiviewer capability (can be used with a maximum of 15 viewers). A PC-compatible station with the viewer function can be multi-PLC (can be used with a maximum of 15 Modicon M340/Atrium/Premium/Quantum platforms).

The buffer/viewer structure supports:

- A single point for fault management in each application
- Time-stamping of the occurrence of faults at source
- Storage of intermittent faults in memory
- Independence with regard to the viewer functions. The frame sent from the PLC buffer is identical for all viewers.
- Automatic archiving of all error messages



Viewer

Output window

The diagnostics viewer takes the form of an output window divided into 2 sections:

- A message list indicating, for each alarm: state, DFB type, geographical zone, dates and times of appearance/disappearance, associated message and status
- An area for additional information about the selected message: type, comment, date of appearance, specific data, variables in error state, etc.

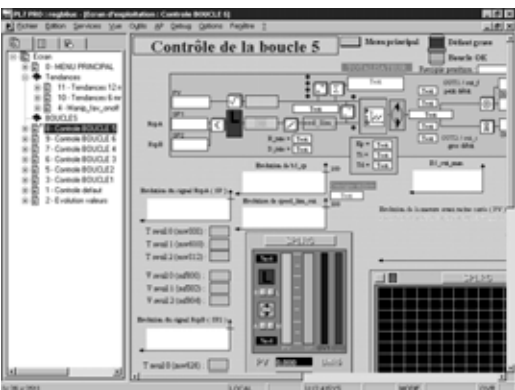

Operator screens

The operator screen tool is integrated into Unity Pro. The operator screens are designed to facilitate the operation of automated processes during debugging, startup and maintenance. The operator screens provide a set of information (explanatory texts, display of dynamic values, push buttons, and synoptics), enabling users to act quickly and easily to modify and dynamically monitor PLC variables.

The operator screens editor provides all the HMI (*Human/Machine Interface*) elements needed for the animated design and viewing of processes. It enables these screens to be designed using specific tools:

- Screen: Creation of runtime screens, which can be classified according to family.
- Message: Creation of messages to be displayed.
- Objects: Creation of a graphic objects library using:
 - Geometrical elements (line, rectangle, ellipse, incorporation of images, controller front panels, etc.)
 - Control elements (buttons, data entry fields, screen browsing controls, etc.)
 - Animation elements (colors, flashing elements, bar graphs, etc.)

When the station on which Unity Pro has been installed is connected to the PLC, the user can obtain a dynamic display of the screens according to the state of the process. Screen sequencing is possible, depending on the priority attributed, either via the keyboard or a PLC request.

When online, the Unity Pro application program can be accessed directly from the operator screens by clicking on the selected object in a synoptic screen view. It is also possible to activate the animation table or cross-reference functions by selecting one or more variables on the screen. To make the display easier to read, the synoptic views can be displayed in full-screen view.

As it is possible to build or modify an operator screen while the PLC is running, this service increases the productivity during the commissioning and maintenance phases.

4

Modifying the program with the PLC in RUN

Unity Pro enables changes to be made to the program when the PLC connected to the programming terminal is in RUN. These modifications are made by performing the following operations:

- When necessary, transferring the application from the PLC to the PC terminal running Unity Pro.
- Preparing the program changes. These program modifications can be of any type and in any language (IL, ST, LD, FBD, and SFC), for example adding/deleting SFC steps or actions. Furthermore, modifications can be made to the code of a DFB user function block (although its interface cannot be modified).
- Updating the program in the PLC (in RUN) to reflect these program changes.

This function allows program code and data in different parts of the application to be added or modified in a single modification session (thus making modification unified and consistent with regard to the controlled process). This increased flexibility comes at a cost in terms of the program memory volume required.

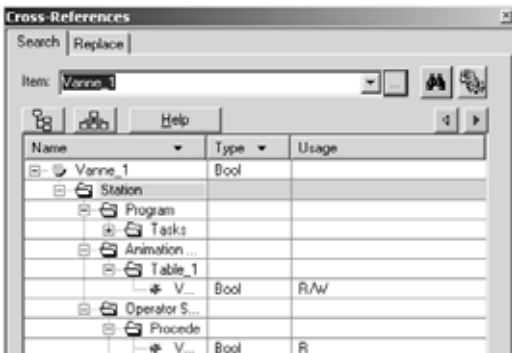

Cross-References functions

The Unity Pro Cross-References function, which is available in standalone mode (offline) and when connected to the PLC (online), allows users to view all the elements of a PLC application by searching for variables of any type. This view indicates where the declared variable is used as well as the mode in which it is used (write, read, etc.).

This function also provides access to the Search/Replace function for variable names.

The variables search can be initialized from any editor (language, data, runtime screen, animation table, etc.).

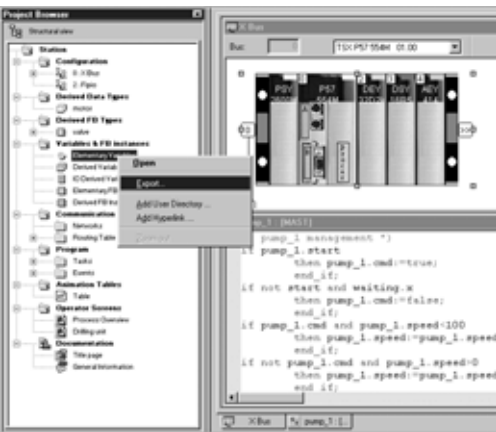

Import/export function

The import/export function available in Unity Pro supports the following operations from the structural and functional project views:

- Via the import function, to reuse all or part of a project created previously in the current project
- Via the export function, to copy all or part of the current project to a file for subsequent reuse

The files generated on export are generally in XML format (1). However, variables can be exported or imported in the following formats in addition to XML:

- .xvm format compatible with OFS data server software
- Source format, in a .scy file compatible with PL7 design software
- Text format with separator (TAB), in a .txt file for compatibility with any other system

On import, data can be assigned to new instances of the following elements via an assistant:

- DFB function blocks
- DDT data structures
- Simple data

Furthermore, when importing a function module, the data associated with animation tables and operator screens is also reassigned.

The XML import function also supports the transfer of a Modicon M340, Atrium, Premium or Quantum PLC configuration prepared in the SIS Pro costing and configuration tool for use in the creation of a project in Unity Pro.

This import function means that the user does not have to repeat the PLC configuration process when this has already been completed in the SIS Pro tool.

(1) XML language: Open text-based language providing structural and semantic information.

Application converters

Unity Pro's integrated conversion tools can be used to convert PLC applications created with Concept and PL7 programming and setup software in Unity Pro applications.

Concept/Unity Pro converter (Quantum PLC)

The conversion can be performed from a Concept V2.5 application (possible in V2.11 or later but only once it has been updated to version V2.5). In order to perform the conversion, the application must be exported to an ASCII file in Concept. The export file is converted into Unity Pro source files automatically. This source file is then analyzed by Unity Pro. At the end of the procedure, a conversion report is generated and an output window displays any conversion errors from which the part of the program to be modified can be accessed directly. The Concept application converter converts the application into Unity Pro but does not guarantee that it will operate correctly in real time. It is therefore essential to test or debug any converted application.

PL7/Unity Pro converter (Premium and Atrium slot PLC)

The conversion can be performed from a PL7 application V4 or later (Premium PLC or Atrium slot PLC). In order to perform the conversion, the source file (complete application) or source file (user function block) must be exported in PL7. The conversion procedure is similar to that of the Concept conversion described above.

Nota : Conversion of PLC applications created with Concept, Modsoft, ProWorx in LL984 is possible. Please consult your Regional Sales Office.

Operating system update utilities

OS-Loader software is designed for updating operating systems on Atrium, Premium and Quantum platforms and is supplied with Unity Pro software. It can be used to upgrade the processor and modules from PL7 or Concept for compatibility with Unity Pro:

- Premium **TSX P57 2●3M/2623M** and **TSX P57 3●3M/3623M** processors
 - Quantum **140 CPU 434 12A** and **140 CPU 534 14A** processors (requires PV 04 or later)
 - Ethernet **TSX ETY ●102** and **140 NOE 771 ●1** communication modules
- These operating system updates are performed as follows for the various types of processor:
- Uni-Telway RS 485 terminal link for Premium processors
 - Modbus or Modbus Plus terminal link for Quantum processors
 - Ethernet TCP/IP network for integrated Ethernet port on Premium processors and Ethernet Premium and Quantum processors (1)

Nota : For Modicon M340 this service is supplied by Unity Loader (see page 4/38)

(1) Updating the OS on a Quantum **140 CPU 671 60** processor is done thru an Ethernet network on its MT-RJ type optical fiber connector (and thru a transceiver or a ConneXium switch for electrical/optical interfacing)

Communication drivers

The drivers used most frequently on the Atrium, Premium and Quantum platforms are installed at the same time as the Unity Pro software.

Furthermore, Unity Pro also includes the following communication drivers, which can be installed as required (1):

Driver type	Windows XP Windows 2000	Windows NT	Windows 98 Millenium	Windows 95
Uni-Telway COM port	V1.9 IE20	V1.9 IE17	V1.7 IE18	V7.8 IE18
Uni-Telway TSX SCP 114	V1.2 IE05			
Modbus COM port	V1.6 IE29			
Fip ISA TSX FPC10 card	V1.4 IE06	V1.3 IE08	V1.4 IE06	V2.4 IE08
Fip TSX FPC20 PCMCIA card	V1.2 IE03	V1.1 IE08	V1.2 IE04	
Ethway	V1.4 IE05	V1.1 IE03	V2.6 IE06 (2)	
ISAWay PCX 57, ISA card	V1.2 IE04	V1.5 IE06	V1.2 IE04	V1.2 IE09
PClway Atrium, PCI card	V1.1 IE09	-		
XIP X-Way on TCP/IP	V1.10 IE22			
USB for USB terminal port	V1.2 IE17	-		

4

Unity Developer's Edition, advanced openness

Advanced openness, which is reserved for experienced IT engineers, supports the development of interfaces between Unity and expert tools as well as specific user-defined functions.

This type of development requires expert IT knowledge in the following areas:

- C++ or Visual Basic languages
- Client/server architectures
- XML and COM/DCOM technologies
- Issues relating to data synchronization

As a supplement to the Unity Pro Extra Large software (3), the UDE (Unity Developer's Edition) development tool **UNY UDE VFU CD21E** can be used to set up made-to-order solutions. In addition to a development kit, it includes the Unity servers and documentation.

Unity Developer's Edition is compatible with:

- Unity Pro Extra Large.
- All Modicon M340 processors.
- All Atrium slot-PLCs.
- All Premium Unity processors.
- All Quantum Unity processors.

(1) Also available as separate part **TLX CD DRV 20M**

(2) Windows 98 only

(3) Only Unity Pro Extra Large implements dynamic databases management for OFS data servers and 3rd party software.

Modicon M340 automation platform

Unity Pro software



References

Unity Pro Small, Medium, Large and Extra Large software packages

The software is available in 4 versions:

- **Unity Pro Small** for programming and setting up Unity automation platforms:
 - Modicon M340 BMX P34 1000 and BMX P34 20●0
- **Unity Pro Medium** for programming and setting up Unity automation platforms:
 - Modicon M340 BMX P34 1000 and BMX P34 20●0
 - Atrium TSX PCI 57 20
 - Premium TSX 57 0●, 57 10 and 57 20
- **Unity Pro Large** for programming and setting up automation platforms:
 - Modicon M340 BMX P34 1000 and BMX P34 20●0
 - Atrium TSX PCI 57 20 and 57 30
 - Premium TSX 57 0●, 57 10, 57 20, 57 30 and 57 40
 - Quantum with 140 CPU 311 10, 434 12U and 534 14U processors
- **Unity Pro Extra Large** for programming and setting up all Unity automation platforms:
 - Modicon M340 BMX P34 1000, and BMX P34 20●0
 - Atrium TSX PCI 57 20 and 57 30
 - Premium TSX 57 0●, 57 10, 57 20, 57 30, 57 40 and 57 50
 - Quantum with 140 CPU 311 10, 434 12U, 534 14U, 651 50, 651 60 and Hot Standby 140 CPU 671 60 processors

Upgrade kits for Concept, PL7 Pro and ProWORX software

Users who have already purchased these installed base software programs **and have a current subscription** may purchase Unity Pro version V3.0 software at reduced prices. These upgrades are only possible for licenses of the same type (from Concept XL group license to Unity Pro Extra Large group license).

OS Windows composition and compatibility

Unity Pro multilingual software is compatible with Windows 2000 Professional and Windows XP operating systems.

It comprises:

- Documentation in electronic format in 6 languages (Chinese, English, French, German, Italian and Spanish)
- Converters for converting applications created with Concept and PL7 Pro programming software
- PLC simulator

Cables for connecting the processor to the programming PC must be ordered separately.

Modicon M340 automation platform

Unity Pro software



References (continued)

Unity Pro Small version 3.0 software packages

For PLCs	Description	Type of license	Reference	Weight kg
BMX P34 1000 BMX P34 2000	Unity Pro Small software packages	Single-station	UNY SPU SFU CD 30	–
		Group (3 stations)	UNY SPU SFG CD 30	–
		Team (10 stations)	UNY SPU SFT CD 30	–
	Software upgrades from: - Concept S - PL7 Micro - ProWORX NxT/32 Lite	Single-station	UNY SPU SZU CD 30	–
		Group (3 stations)	UNY SPU SZG CD 30	–
		Team (10 stations)	UNY SPU SZT CD 30	–

Unity Pro Medium version 3.0 software packages

For PLCs	Description	Type of license	Reference	Weight kg
BMX P34 1000 BMX P34 2000 TSX 57 0...57 20 TSX PCI 57 20	Unity Pro Medium software packages	Single-station	UNY SPU MFU CD 30	–
		Group (3 stations)	UNY SPU MFG CD 30	–
		Team (10 stations)	UNY SPU MFT CD 30	–
	Software upgrades from: - Concept S, M - PL7 Micro, Junior - ProWORX NxT/32 Lite	Single-station	UNY SPU MZU CD 30	–
		Group (3 stations)	UNY SPU MZG CD 30	–
		Team (10 stations)	UNY SPU MZT CD 30	–

Unity Pro Large version 3.0 software packages

For PLCs	Description	Type of license	Reference	Weight kg
BMX P34 1000 BMX P34 2000 TSX 57 0...57 40 TSX PCI 57 20/30 140 CPU 311 10 140 CPU 434 12U 140 CPU 534 14U	Unity Pro Large software packages	Single-station	UNY SPU LFU CD 30	–
		Group (3 stations)	UNY SPU LFG CD 30	–
		Team (10 stations)	UNY SPU LFT CD 30	–
		Site (> 10 stations)	UNY SPU LFF CD 30	–
	Software upgrades from: - Concept S, M - PL7 Micro, Junior, Pro - ProWORX NxT/32 Lite	Single-station	UNY SPU LZU CD 30	–
		Group (3 stations)	UNY SPU LZG CD 30	–
		Team (10 stations)	UNY SPU LZT CD 30	–
		Site (> 10 stations)	UNY SPU LZF CD 30	–

Unity Pro Extra Large version 3.0 software packages

For PLCs	Description	Type of license	Reference	Weight kg
BMX P34 1000 BMX P34 2000 TSX 57 0...57 50 TSX PCI 57 20/30 140 CPU 311 10 140 CPU 434 12U 140 CPU 534 14U 140 CPU 651 50/60 140 CPU 671 60	Unity Pro Extra Large software packages	Single-station	UNY SPU EFU CD 30	–
		Group (3 stations)	UNY SPU EFG CD 30	–
		Team (10 stations)	UNY SPU EFT CD 30	–
		Site (> 10 stations)	UNY SPU EFF CD 30	–
	Software upgrades from: - Concept S, M, XL - PL7 Micro, Junior, Pro - ProWORX NxT Lite, Full - ProWORX 32 Lite, Full	Single-station	UNY SPU EZU CD 30	–
		Group (3 stations)	UNY SPU EZG CD 30	–
		Team (10 stations)	UNY SPU EZT CD 30	–
		Site (> 10 stations)	UNY SPU EZF CD 30	–

Unity Developer's Edition

For PLCs	Description	Type of licence	Reference	Masse kg
BMX P34 1000 BMX P34 2000 TSX 57 0...57 50 TSX PCI 57 20/30 140 CPU 311 10 140 CPU 434 12U 140 CPU 534 14U 140 CPU 651 50/60 140 CPU 671 60	UDE Unity Developer's Edition Requires Unity Pro Extra Large	Single-station	UNY UDE VFU CD21E	–

Modicon M340 automation platform

Unity Pro software

References (continued)

Documentation for Unity Pro version 3.0

For PLCs	Description	Type of license	Reference	Weight kg
Hardware and software manuals (on DVD)	Platform setup for: - Modicon M340 - Atrium/Premium - Quantum - Momentum Electromagnetic compatibility of networks and fieldbuses Software setup for: - Unity Pro - EF/EFB/DFB function blocks library	Multilingual: Chinese, English, French, German, Italian and Spanish	UNY USE 909 CD M	–

Separate parts

Description	Use from processor	To PC port	Length	Reference	Weight kg
PC terminal connection cables	USB Mini B port Modicon M340 BMX P34 1000/20●0	USB port	1.8 m	BMX XCA USB 018	–
			4.5 m	BMX XCA USB 045	–
	Mini-DIN port for Premium TSX 57 1●/2●/3●/4● Atrium TSX PCI 57	RS 232D (15-way SUB-D connector)	2.5 m	TSX PCX 1031	0.170
		USB port (USB/RS 485 converter)	0,4 m	TSX CUSB 485 (1)	0,144
		USB port (Mini-DIN/RJ45 cordset)	2.5 m	TSX CRJMD 25	0.150
	Modbus port 15-way SUB-D Quantum 140 CPU 311 10 140 CPU 434 12A 140 CPU 534 14A	RS 232D (15-way SUB-D connector)	3.7 m	990 NAA 263 20	0.300
			15 m	990 NAA 263 50	0.180
	USB port Premium TSX 57 5● Quantum 140 CPU 6●1	USB port	3.3 m	UNY XCA USB 033	–
	RJ45 connector for Modbus port Quantum 140 CPU 6●1	RJ45 connector	1 m	110 XCA 282 01	–
			3 m	110 XCA 282 02	–
			6 m	110 XCA 282 03	–

(1) With TSX CUSB 485 converter, use the TSX CRJMD25 cordset.



TSX PCX 1031



TSX CUSB 485



Presentation

Unity EFB Toolkit is the software for developing EF functions and EFB function blocks in C language and is optional software for Unity Pro. It can be used to develop new functions (whose internal code is written in C language) to extend and complete the set of functions proposed as standard in Unity Pro. This software comes with Microsoft Visual C++ @.Net which can be used to debug the functions used on the Unity Pro PLC simulator. Unity EFB Toolkit also includes a service for creating and managing families of functions, with a view to their integration in the Unity Pro function libraries.

Setup

C language development software is a proper tool for managing the whole function while it is being performed:

- A user-friendly creation interface, integrated in Unity Pro, with automatic file organization
- Powerful tools for testing and debugging
- Management of compatibilities and software versions of created functions
- Generation of files for subsequent installation of functions on other development stations

Managing function families

The software can be used to define different function families. These functions, also known as EFs/EFBs, are stored in families, making it possible to create an organized library of functions written in C language.

Once created, these families can be distributed and integrated in the Unity Pro libraries.

They are:

- Arranged in families/functions
- Used in all languages with the same flexibility as standard functions (data entry wizard)
- Managed by the Unity Pro library tool (version management)

Editing functions

The various tabs in the EFB Toolkit software editor allow the user to create the function by:

- Declaring the interface, all data types are possible (elementary, structures, tables)
- Supporting public and private variables

Writing the source code file in C language

A function written in C language can access numerous internal PLC services such as the real-time clock, PLC variables, system words, math functions. In particular, it is possible to perform numerical processing in floating point format.

4



Setup (continued)

Debugging functions

The function created can be tested after insertion in an application and loading into the Unity Pro PLC simulator.

The Microsoft Visual C++ tool is used to debug the function.

It is used to:

- Insert breakpoints
- Perform step by step execution
- Display the code with the breakpoints visible
- Display manipulated data

Nota : To generate the code for a Modicon M340 platform, a specific GNU compiler is used. It is supplied with the Unity EFB Toolkit.



Enhancing the function library

As the function has been debugged, it can be generated and distributed, and the updating tool supplied with Unity Pro can be used to enhance the libraries on a user station.

Version management means that at any time the user knows the level of functions installed on a station and can update the application with the latest existing versions.

Compatibility

Unity EFB Toolkit is compatible with Unity Pro Small, Medium, Large, and Extra Large.

Developing EF functions and EFB functions is possible for the Modicon M340, Premium, Atrium, and Quantum platforms.

References

The "companion" software for Unity Pro, Unity EFB Toolkit can be used to create EF elementary blocks and EFB elementary function blocks. These are developed in Visual C++ language and are integrated in Unity Pro function block libraries.

The Unity EFB Toolkit software and its documentation are supplied in electronic form on CD-ROM in English.

Description	Type of license	Language	Reference	Weight kg
Unity EFB Toolkit, kit for developing EF and EFB blocks	Single (1 station)	English (software and electronic documentation)	UNY SPU ZFU CD 30E	—



Modicon M340 automation platform

Unity SFC View software

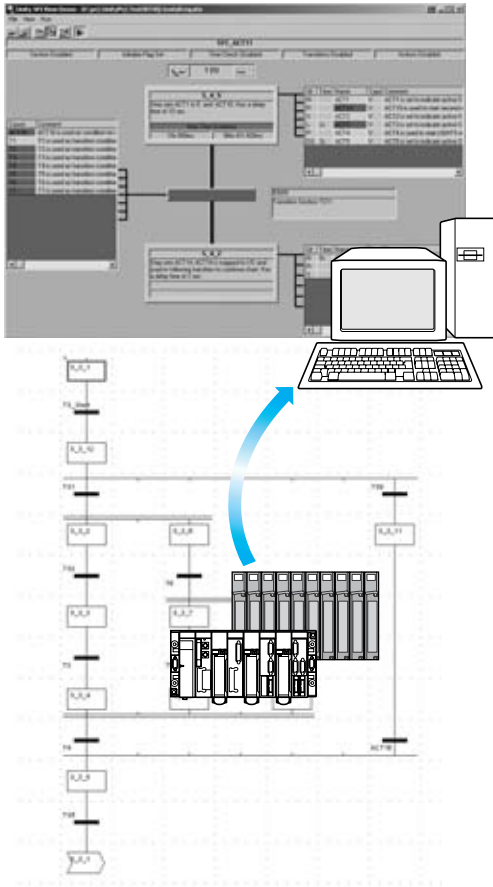

Presentation

Unity SFC View is integrated in human/machine interface (HMI) applications for monitoring Unity Pro sequential applications written in sequential function chart language (SFC or Grafset) executed by a PLC.

Set up in the same way as an ActiveX control component, Unity SFC View is used to display status information relating to SFC charts executed by a Modicon M340, a Premium or a Quantum PLC. Installed on an HMI station, Unity SFC View monitors and controls the status of SFC charts in real time, supplying detailed diagnostic data.

Unity SFC View reads the necessary data from the Unity project database in offline mode. The PLC data is accessed online via the OFS (*OPC Factory Server*).

Without needing to recreate SFC charts in the HMI environment, Unity SFC View reads the structure of the SFC charts directly from the Unity project database. Modifications made to the SFC application are detected and updated at any time. In online mode, Unity SFC View accesses the PLC diagnostic data, thus enabling awareness and tracking of the occurrence of the first fault and subsequent faults. System downtime is much reduced since Unity SFC View enables maintenance staff to locate the source of the problem much more quickly.

Unity SFC View is designed for end users and system designers who wish to integrate this control into their HMI system. Unity SFC View is compatible with most HMI platforms handling ActiveX Control components such as Vijeo Look control software or Monitor Pro supervisory software or in a programming environment such as Visual Basic.

4

Modicon M340 automation platform

Unity SFC View software

The 3 Unity SFC View views

Unity SFC View offers 3 views:

- An overview for managing selection of SFC charts
- Two detailed views presenting the status and diagnostic data of the selected SFC chart



Overview

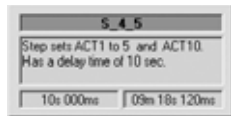

Simple detailed view



Detailed view

The overview provides a general view of all the SFC charts in a Unity project. It contains real-time data such as current step, simultaneous steps, chart error with indication of the SFC chart status. The overview makes it easy to browse through SFC charts and switch quickly to the detailed view of the desired SFC chart in the Unity Pro application.

The simple detailed view shows the elementary data on the active step (or selected step) of the SFC chart in real time. The data displayed may include the name, comment, chart and step status, as well as the activity times (min, max, actual). You can also enable the chart navigation option.

Because of the compact size of the simple detailed view, it is possible to place several instances of it on a single HMI screen relating to a certain part of the process. From this simple detailed mode, you can navigate between HMI screens with SFC View controls and display the detailed view of SFC charts.

The detailed view illustrates the details of an SFC chart in real time. The display indicates the current step, the transition awaiting activation and the next step. The actions associated with the steps are displayed along with sequence selections or parallel branches. The detailed diagnostic data includes analysis of the causes of the fault at transition level. Depending on the diagnostic mode, the error grid contains the causes of errors or all the variables assigned to the transition logic. The current state of the various variables and selected errors are identified by different colors.

Diagnostic mode

Transition logic diagnostics is a key function of Unity SFC View. It minimizes system downtimes in the event of a fault.

Two different diagnostic modes are available:

- Unity SFC View reads the data in the Unity PLC diagnostic buffer. It provides information about faulty or missing events that are preventing the transition from being enabled. This mode does not require any configuration or additional programming in the PLC program.
- Unity SFC View monitors the internal logic of the transition conditions “back to front”. This mode provides diagnostic data concerning all the inputs connected to the transition (not limited to faulty inputs). In this mode, for Premium, Atrium and Quantum platforms, Unity SFC View uses specific EFB function blocks linked to the transition conditions. The library for these blocks is supplied with the Unity SFC View software.

Customization

Unity SFC View offers a programming interface which can be used to integrate the ActiveX Control component in an HMI application and customize its functions and its operator interface.

The ActiveX Control component in Unity SFC View can be customized. It accepts properties, methods and events (all the properties have a default value). The properties pages simplify configuration. Unity SFC View accepts scripts with methods such as browsing through charts, status control of charts, and also events such as error notification or chart selection. This data can be used to launch programs or operator screens.

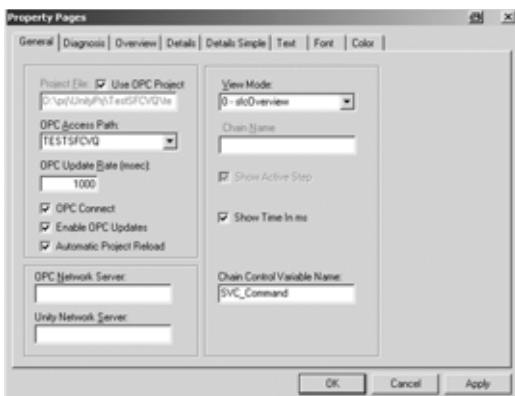

SFC View properties page

Modicon M340 automation platform

Unity SFC View software

Possible architectures

Basic architecture

Unity SFC View is used in a configuration where the OFS and Unity Pro software reside on the same PC platform as the HMI application.

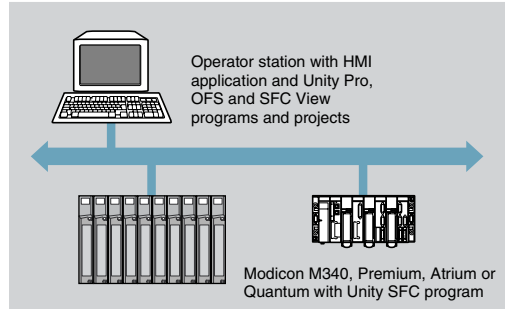

Distributed architecture

In a distributed configuration, the OFS and Unity Pro software can be installed on different servers.

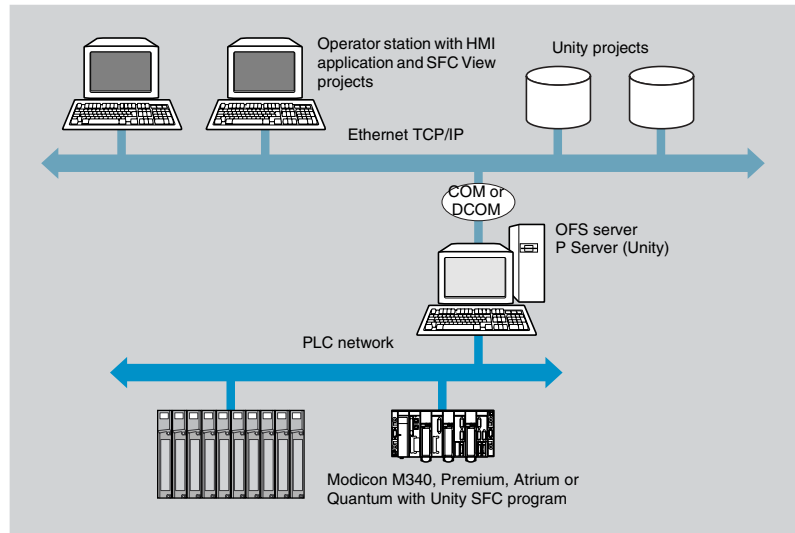

4

Modicon M340 automation platform

Unity SFC View software



References

When integrated in an HMI application, Unity SFC View can be used to monitor and control charts in applications developed in Sequential Function Chart (SFC) language running on Premium/Quantum Unity PLCs.

The HMI station, compatible with Windows 2000 or Windows XP Professional operating systems, must support ActiveX Control components. Unity SFC View V2.0 requires:

- Unity Pro V3.● XL, to be ordered separately
- OFS V3.3 data server software, to be ordered separately

Unity SFC View multilingual software, supplied on a CD-ROM, includes:

- The SFC View ActiveX Control component
- The EFB function block library for Unity Pro V3.●
- An example of how to integrate SFC View in Unity Pro projects
- The electronic documentation (English, French and German)

The Unity SFC View integration example illustrates the main possibilities offered by Unity SFC View. This is an executable program which does not need HMI software in order to run. It helps the user understand how to configure and use the Unity SFC View ActiveX Control component.

Description	Type of license	Reference	Weight kg
Unity SFC View software packages (version V2.0)	Single (1 station)	UNY SDU MFU CD20	–
	Team (10 stations)	UNY SDU MFT CD20	–
	Site (100 stations)	UNY SDU MFF CD20	–



Presentation

Unity Loader is companion software to Unity Pro and is used to perform maintenance operations on automation applications. Its easy setup and the small size of its executable make it an essential tool for updating Modicon M340 PLC projects when it is not necessary to read or modify the program. It is also essential software for updating the embedded software on the M340 PLC. It performs the following two main functions:

- Transfer of automation project components from the PC to the PLC or from the PLC to the PC, such as the program, data, files and user Web pages stored in the memory cartridge
- Transfer of embedded software from the PC to the processor or Ethernet communication modules

Software graphic interface

The software is designed to be used by people with limited automation expertise. The interface consists of four tabs, and buttons within each of the tabs to perform different operations.

- The first tab, "Project", is used for project transfers: program, data and user files. The three exchange operations between the PC and the processor can be sequenced together in a single command.
- The second tab, "Operating System", is used to update the embedded software in the PLC. The screen displays the detailed content of the PLC firmware versions, and, when a file is selected on the PC, the characteristics of that file are displayed.
- The third tab, "Options", is used to configure the working environment, including the location of files on the PLC, selection of one of six languages (English, French, German, Italian, Spanish, Chinese) for the interface and online help, etc. The last tab can be used to display information about the software.

Note: Regardless of which tab is selected, the connection status with the PLC is displayed, together with commands for connection/disconnection and changing the PLC operating mode.



Unity Loader: "Project" tab

Modicon M340 PLC project transfer

Exchanges between the PC and the PLC processor

The software can be used to transfer the components of a project in either direction:

- Program: binary and source, if the application has been built using the source format
- Data file: located and unlocated data
- Data on the processor memory cartridge: user files (if the cartridge allows this)

Unity Pro can be used to transfer the application from either the application file .stu, or the archive file .sta. The program file and data formats, together with the functions performed by Unity Loader, are identical to those built and used by Unity Pro.

When the cartridge-based user files are transferred from the PLC to the PC, a private file specific to Unity Loader is created. The operation is then possible in the other direction. Unity Pro cannot be used to perform this type of transfer.

In order to simplify project management, Unity Loader defaults to store the three files read in the PLC in the same directory with an identical file name (the project name by default), but with a different file extension. The default choice suggested can be modified by the user.

Once connected to the PLC, Unity Loader displays the characteristics of the data read in the PLC. Similarly, when the files are selected on the PC, the corresponding characteristics are also displayed. All the data necessary to decide on the action required is displayed on a single screen. The three components of the project are selected by default, provided that they are valid for the chosen direction of transfer. Transfer of one or two of the components can be disabled. All of the transfers are performed in a single command.

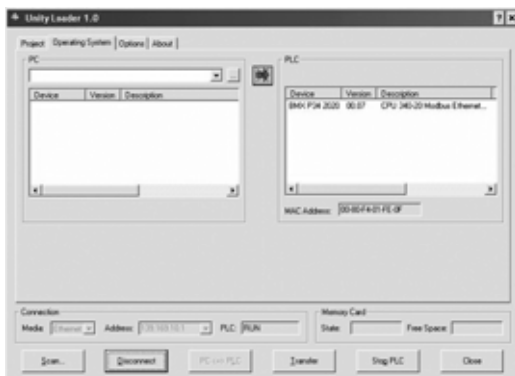

Unity Loader: "Operating System" tab

4

Modicon M340 PLC project transfer (continued)

File transfer to the Modicon M340 PLC Ethernet communication module

The BMX NOE 0100/BMX NOE 0110 communication modules contain a memory cartridge that can store user web pages, depending on the model used. When Unity Loader is connected to the communication module, web pages can be transferred from the module to the PC or vice versa. The operating mode is identical to that available for exchanges with the processor.

Updating embedded software in the Modicon M340 processor and Ethernet communication modules

Firmware can be updated by following the same principle as that used for for transferring projects.

Once connected to the PLC, Unity Loader displays the characteristics of the firmware read in the PLC. Similarly, when a file corresponding to a valid file for the firmware is selected on the PC, the corresponding characteristics are also displayed. All the data necessary to decide on whether the update should be performed is displayed on a single screen.

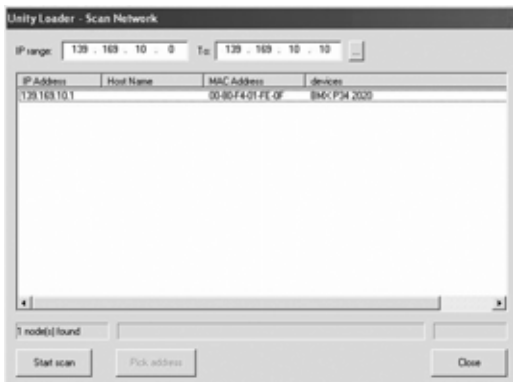

Unity Loader: Network scanning

Communication between the PC and the PLC

Unity Loader uses two communication vectors, USB and Ethernet. USB is always available for exchanges with the PLC processor. Ethernet is essential for exchanges with the Ethernet modules and can also be used for exchanges with processors which have an integrated Ethernet port.

PLC	Type	Ethernet port	USB port
BMX P34 1000	CPU		
BMX P34 2010	CPU		
BMX P34 2020	CPU		
BMX P34 2030	CPU		
BMX NOE 0100	Ethernet module		
BMX NOE 0110	Ethernet module		

Supported

When Unity Loader is connected to an Ethernet network, it is possible to define a range of addresses to be scanned and thus display all the devices recognized on the network. By selecting the Modicon M340 PLC, the transfer operations can then be performed.

All connection and transfer operations, together with any errors, are recorded in a trace file stored in the PC.

Compatibility

Unity Loader is compatible with Modicon M340 PLCs. Its use is totally independent from Unity Pro. Program files and PLC data are compatible between Unity Pro and Unity Loader.

Reference

Unity Loader is available in two formats. It is automatically provided with all versions of Unity Pro Small, Medium, Large and Extra Large. It can be ordered separately under a unit reference.

The product includes a graphic interface and documentation in six languages (English, French, German, Italian, Spanish, Chinese).

Description	Type	Reference	Weight kg
Unity Loader	Single license	UNY SMU ZUCD30	—



5 - Advantys Telefast ABE 7 pre-wired I/O system

- *Advantys Telefast ABE7 selection guide* page 5/2
- Presentation, combinations page 5/8
- References
 - Passive connection sub-base for discrete inputs/outputs page 5/10
 - Adaptation sub-bases with soldered relays and removable terminal blocks page 5/12
 - Adaptation sub-bases for or with plug-in relays page 5/13
 - Plug-in relays page 5/15
 - Connection sub-bases for counter and analogue channels page 5/16
 - Accessories for connection sub-bases page 5/17
- Dimensions page 5/18

Connection interfaces

Advantys Teleafast ABE 7 pre-wired system
Discrete input and/or output sub-bases

Applications	Discrete inputs or outputs		
	Optimum "Low cost"	Optimum "Miniature"	Universal

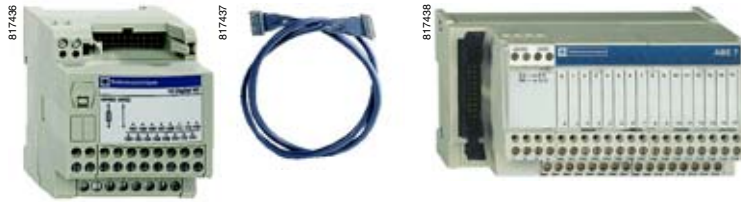

Relay amplification	-			
Equipped with relay	-			
Control voltage	= 24V			
Output voltage	= 24V			
Output current per channel	0.5 A			
Modularity	16		8 -12 -16	
No. of terminals per channel	1	1 to 3	1	2
Type of connection terminals	Signal	Signal, common (configurable = 24 V or 0 V)	Signal	Signal, common (configurable = 24 V or 0 V)
Connectors	20-way HE10 connector			
Terminal block	Removable	No		No
	Terminal type	Screw		Screw or spring
Additional or optional* function	Low cost version fitted with cable	Miniature sub-bases	Compact size *	Type 2 input * (1)
Device type	ABE 7H20E●●● ABE 7H32E●●●	ABE 7H16C●●	ABE 7H●●R1● ABE 7H●●R50	ABE 7H●●R2● ABE 7H●●S21
Pages	5/10		5/11	

(1) For TSX Micro and Premium PLCs

5

Discrete inputs and outputs

Optimum "Miniature"

Optimum



-		Plug-in electromechanical or solid state	
-		No	Yes
≡ 24V			
≡ 24V		≡ 24V (solid state) ≡ 5... 24V, ~ 230 V (electromechanical)	
0.5 A	0.5 A	5 A (E.M.), 2 A (solid state)	5 A (th)
16		16 8 passive inputs 8 relay outputs	
1	2	1	
Signal, 2 common connections between the inputs and the outputs.	Signal, common, 2 common connections between the inputs and the outputs.	1 N/O contact and common, 4 output channels 2 input connection points	
20-way HE10 connectors			
No			
Screw			
Miniature sub-base Synergy with Tego Power and Micro PLC		Miniature sub-base - Common per 4 channels Synergy with Tego Power and Micro PLC	
ABE 7H16CM11	ABE 7H16CM21	ABE 7P16M111	ABE 7R16M111
5/10		5/14	5/13

5

Connection interfaces

Advantys Telefast ABE 7 pre-wired system Discrete input and output sub-bases

Applications	Discrete output			
	“Optimum”	“Universal”	“Optimum”	“Universal”



Relay amplification	Electromechanical, fixed		Electromechanical or solid state			
Equipped with relay	Yes		Yes	No	No	
Control voltage	≍ 24 V					
Output voltage	≍ 5 V... 30 V ~ 230 V		≍ 5 V... 150 V ~ 230 V	≍ 24 V (solid state) ≍ 5 V... 24 V, ~ 230 V (E.M.)		≍ 5 V... 150 V ~ 230 V
Output current per channel	2 A (th)	3 A (th)	5 A (th)	2 A (solid state), 6 A (electromechanical)		Depends on relay mounted 0.5 to 10 A
Modularity	8	8 - 16		16		8 or 16
No. of terminals per channel	2	1	2	1	2 to 3	
Type of connection terminals	1 N/O contact and common Volt-free	1 N/O contact	1 N/O contact and common	1 N/O contact	Signal, Polarities	
Connectors	20-way HE 10 connector					
Terminal block	Removable	Yes	Yes	Yes	No	No
	Terminal type	Screw or spring			Screw	
Additional or optional* function	Miniature sub-base Latching relay	Volt-free or common per 8 channels		Miniature sub-bases Common per 4 channels		Isolator and fuse
Device type	ABE 7R08S216●	ABE 7R●●S1●●	ABE 7R●●S2●●	ABE 7R16T111	ABE 7P16T111	ABE 7P16T2●●● ABE 7P08T3●●●
Pages	5/12			5/13	5/14	

5

Discrete outputs	Discrete inputs				
“Universal”	“Universal”				

817439



Electromechanical, plug-in		Solid state, fixed		–	–	Solid state, fixed	Solid state, plug-in
Yes		Yes		–	–	Yes	No
= 24 V						From = 24 V to ~ 230 V	From 5 V TTL to ~ 230 V
= 5 V... 150 V ~ 230 V		= 24 V					
5A (th)	8 A (th)	from 0.5 to 2 A	125 mA	0.5 A	125 mA	12 mA	
16							
2 to 3	2 to 6	2		3	2		
1 C/O contact or 1 N/O contact and common	1 C/O contact or 2 C/O contacts and common	Signal and 0 V		Signal = 24 V and 0 V	Signal can be isolated, Protected common	Signal	Signal and common
20-way HE 10 connector							
No		Yes	No	No	Yes		No
Screw		Screw or spring		Screw		Screw or spring	
Volt-free or common per:		Fault signal	Isolator and fuse (indicator)	3-wire proximity sensor	Isolator and fuse (indicator)	–	
8 channels	4 channels						
ABE 7R16T2●●	ABE 7R16T3●●	ABE 7S●●S2B●	ABE 7H16F43	ABE 7H16R3●	ABE 7H16S43	ABE 7S16E2●●	ABE 7P16F31●
5/13		5/12	5/11		5/12		5/15

5

Applications **Analogue signals and special functions**



Compatibility	TSX Micro	Premium		Standard	Modicon M340 BMX ART 0414 / 0814 BMX AMI 0410
Type of signal	Counter inputs and analogue I/O	Counter inputs Axis control Position control	Analogue inputs Current Voltage Pt 100	Analogue outputs Current Voltage	Analogue inputs
Functions	Passive connection, point-to-point with shield continuity				Direct connection Cold-junction compensation or distributed 4 protected isolated power supplies
Modularity	1 counter channel or 8 analogue inputs + 2 analogue outputs	8 channels	4 channels	4 channels	4 channels
Control voltage	≡ 24 V				–
Output voltage	≡ 24 V				–
Output current per channel	25 mA				–
No. of terminals per channel	2	2 or 4	2 or 4	2 or 4	2 or 4
Connector type	15-way SUB-D + 9-way SUB-D		25-way SUB-D		25-way SUB-D
Terminal block	Removable Terminal type	No Screw	No Screw	No Screw	No Screw
Device type	ABE 7CPA01		ABE 7CPA02	ABE 7CPA21	ABE 7CPA412/410
Pages	5/16				

5

Analogue signals and special functions



Standard	Premium TSX AEY810	Premium TSX CAY●1 TSX CTY2C	Premium TSX AEY1614	Premium TSX PAY2●2
Analogue inputs Current Voltage Pt 100	Isolated analogue inputs	Inputs Counter	Inputs for thermocouples	Inputs/outputs
Distribution of sensor power supplies per limiter (25 mA)	Distribution of isolated sensor power supplies per converter	Acquisition of value from an absolute encoder	Connection of 16 thermocouples with cold junction compensation	Safety module (BG)
8 channels	8 channels	1 channel	16 channels	12 Emergency stops
— 24 V				
— 24 V				
25 mA				—
2 or 4		—	2 or 4	1
25-way SUB-D	25-way SUB-D	15-way SUB-D	25-way SUB-D	50-way SUB-D
No	No	No	No	No
Screw	Screw or spring	Screw	Screw	Screw
ABE 7CPA03	ABE 7CPA31●	ABE 7CPA11	ABE 7CPA12	ABE 7CPA13
5/16				

Connection interfaces

Advantys Telefast ABE 7 pre-wired system
Interface with Modicon M340 I/O modules

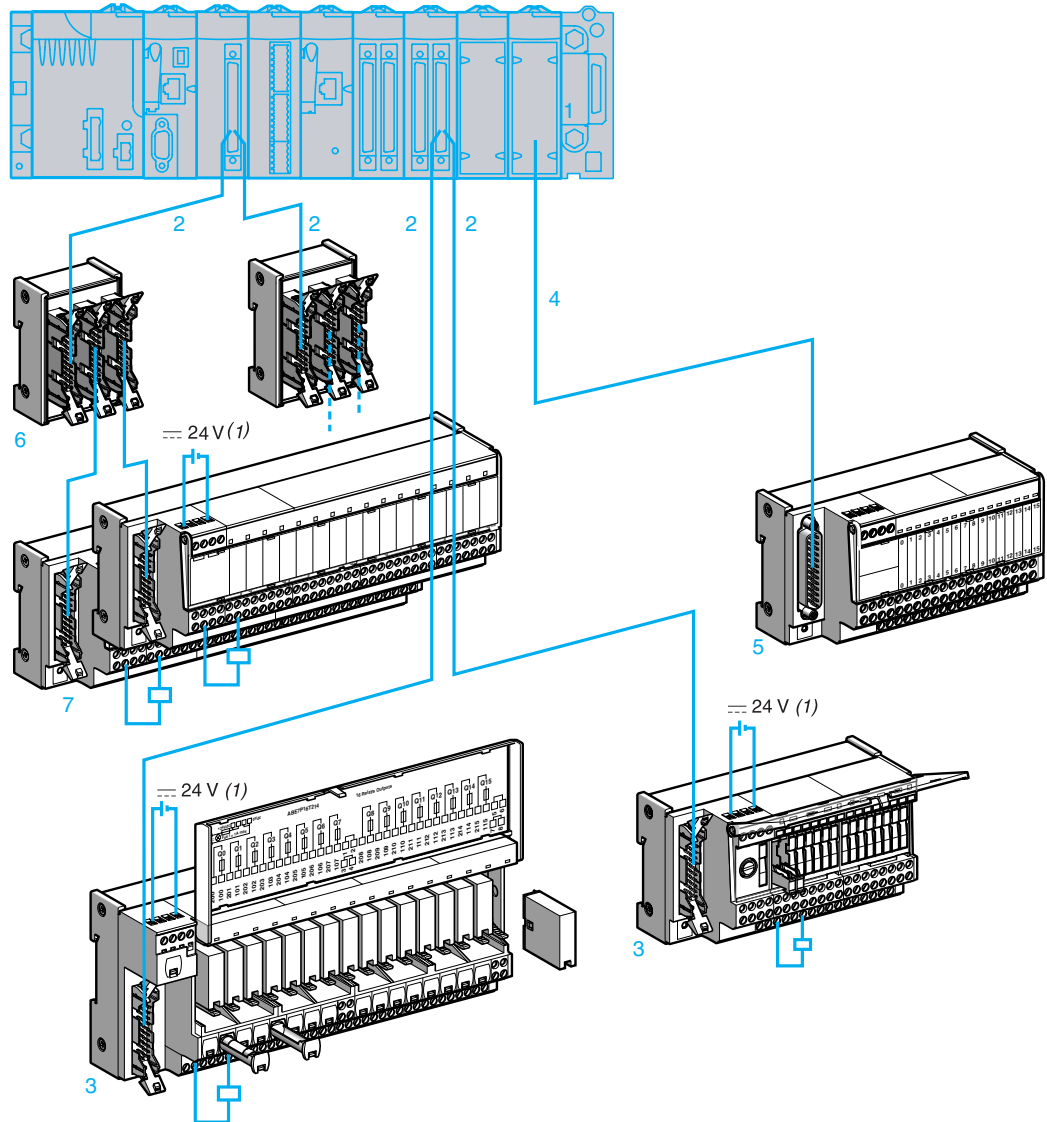

- 1 Discrete **BMX DDI ●●02K** input modules, **BMX DDO ●●02K** output modules and **BMX DDM 3202K** mixed I/O modules equipped with one or two 40-way FCN connectors. The module modularity (●●) is 32 or 64 channels.
- 2 Cordset equipped with connectors (one 40-way FCN connector with one or two 20-way HE 10s). 2 models are available: cordsets with one or two 20-wire sheaths (AWG 22) equipped with an HE 10 moulded connector, **BMX FCC ●●1/●●3**.
These cordsets are available in 0.5, 1, 2, 3, 5 or 10 m lengths.
- 3 16-channel Optimum or Universal Advantys Telefast ABE 7 passive connection sub-bases or adaptor sub-bases.
- 4 Cordset equipped with connectors (including one 25-way SUB-D type on the sub-base end). 2 models are available, depending on the type of connections on the analog module side:
 - 20-way screw terminal block, **BMX FCA●●0** cordset for **ABE 7CPA410** sub-bases
 - 40-way FCN connector, **BMX FCA●●2** cordset for **ABE 7CPA412** analog input module
 These cordsets are available in 1.5, 3 or 5 m lengths.
- 5 Sub-bases for analog input modules:
 - **ABE 7CPA410** for connection on a screw terminal block of 4 current/voltage inputs of the **BMX AMI 0410** analog module, with supply of 4 isolated protected power supplies for the current loop inputs.
 - **ABE 7CPA412** for connection on a screw terminal block of 4 thermocouple inputs for the **BMX ART 0414/0814** analog module, with supply of cold-junction compensation for these inputs.
- 6 **ABE 7ACC02** sub-base for splitting 16 into 2 x 8 channels, allows connection to an 8-channel sub-base.
- 7 8-channel Optimum or Universal Advantys Telefast ABE 7 passive connection sub-bases or adaptor sub-bases.

(1) Connection of the 24 V $\overline{\text{---}}$ power supply is only possible using Advantys Telefast ABE 7 sub-bases. Equipotentiality of the 0 V $\overline{\text{---}}$ supplies is compulsory.

I/O modules on the Modicon M340 platform

		Discrete 24 V ---					Analog			
		Inputs		Outputs		Inputs/ Outputs	Inputs		Outputs	
		2 x 16 I	4 x 16 I	2 x 16 Q	4 x 16 Q		1 x 16 I 1 x 16 Q	4 I		4 I
With Modicon M340 modules	BMX	DDI 3202K	DDI 6402K	DDO 3202K	DDO 6402K	DDM 3202K	AMI 0410	ART 0414	ART 0814	AMO 0210
Preformed cordsets (at both ends)	BMX	FCC●●1/FCC●●3				FCC●●3	FCA●●0	FCA●●2	FCA●●0	
Passive connection sub-bases										
Optimum	ABE 7H20E●●0	"low-cost"								
16 channels	ABE 7H16C●●	"miniature"								
Universal	ABE 7H08R●●	(1)	(1)	(1)	(1)	(1)				
8 channels	ABE 7H08S21	(1)	(1)	(1)	(1)	(1)				
Universal	ABE 7H16R1●●									
16 channels	ABE 7H16R50●●									
	ABE 7H16R2●●									
	ABE 7H16S21●●									
	ABE 7H16R3●●									
	ABE 7H16R23									
	ABE 7H16S43									
	ABE 7H16F43									
Input adaptor sub-bases with solid state relays										
Universal	ABE 7S16E2●●●									
16 channels	Welded solid state relays, removable terminal blocks									
	ABE 7P16F31●●									
	Removable solid state relays									
Output adaptor sub-bases with welded relays, removable terminal blocks										
Optimum & Universal	ABE 7S08S2B●●			(1)	(1)	(1)				
8 channels	Solid state relays			(1)	(1)	(1)				
	ABE 7R08S111●●/7R08S21●●			(1)	(1)	(1)				
	Electromechanical relays									
Optimum & Universal	ABE 7S16S●●B●●									
16 channels	Solid state relays									
	ABE 7R16S111●●/7R16S21●●									
	Electromechanical relays									
Output adaptor sub-bases with removable relays										
Universal	ABE 7P08T330●●			(1)	(1)	(1)				
8 channels	Solid state relays			(1)	(1)	(1)				
Optimum & Universal	ABE 7R16T●●●/7R16M111									
16 channels	Electromechanical relays									
	ABE 7P16T●●●/7P16M111									
	Solid state and/or electromechanical relays									
Sub-bases for analog I/O										
4 channels	ABE 7CPA410									
	ABE 7CPA412									
	ABE 7CPA21									

 Preformed cordsets

(1) Via the ABE 7ACC02 splitter sub-base used to separate 16 channels into 2 x 8 channels

Connection interfaces

Advantys Telefast ABE 7 pre-wired system
Passive connection sub-bases

816460



816461



ABE 7H20E●●●

Passive connection sub-base for discrete inputs/outputs

Optimum "Low cost" sub-bases

Function	No. of channels	No. of terminals per channel	No. of terminals on row	For PLCs	Length of PLC connection cable	Type of connection	Reference	Weight
					m			kg
Input or output	16	1	2	Modicon M340/Premium	1	Screw	ABE 7H20E100	0.330
					2	Screw	ABE 7H20E200	0.410
					3	Screw	ABE 7H20E300	0.480
				Siemens S7	1.5	Screw	ABE 7H32E150	0.360
					3	Screw	ABE 7H32E300	0.460

Optimum "Miniature" sub-bases

Function	No. of channels	No. of terminals per channel	No. of terminals on row	LED per channel	Polarity distribution	Type of connection	Reference	Weight				
								kg				
Input or output	16	1	1	No	No	Screw	ABE 7H16C10	0.160				
				Yes	No	Screw	ABE 7H16C11	0.160				
				Yes	0 or 24 V	Screw	ABE 7H16C21	0.205				
				Yes	0 or 24 V	Screw	ABE 7H16C31	0.260				
				Input and output (1)	16	1	1	Yes	No	Screw	ABE 7H16CM11	0.160
								Yes	0 or 24 V	Screw	ABE 7H16CM21	0.200

816463



ABE 7H16C21

816462



ABE 7H16CM21

(1) 8 I + 8 O: these products have 2 commons connections which enable inputs and outputs to be connected to the same sub-base at the same time.

Passive connection sub-base for discrete signals (continued)

Universal sub-bases

Function	No. of channels	No. of terminals per channel	No. of terminals on row per channel number	LED per channel	Polarity distribution	Isolator (I) Fuse (F) per channel	Type of connection	Reference	Weight kg	
Input or output	8	1	1	No	No	–	Screw	ABE 7H08R10	0.187	
				Yes	No	–	Screw	ABE 7H08R11	0.187	
		2	2	Yes	0 or 24 V	–	Screw	ABE 7H08R21	0.218	
				I	–	Screw	ABE 7H08S21	0.245		
		12	1	1	No	No	–	Screw	ABE 7H12R10	0.274
					Yes	No	–	Screw	ABE 7H12R11	0.274
	2		2	No	No	–	Screw	ABE 7H12R50	0.196	
				Yes	0 or 24 V	–	Screw	ABE 7H12R20	0.300	
	16	1	1	No	No	–	Screw	ABE 7H16R10	0.274	
				Yes	No	–	Screw	ABE 7H16R11	0.274	
		2	2	No	No	–	Screw	ABE 7H16R50	0.196	
				Yes	0 or 24 V	–	Screw	ABE 7H16R21	0.300	
2		2	No	0 or 24 V	–	Screw	ABE 7H16R20	0.300		
			Yes	0 or 24 V	–	Screw	ABE 7H16R21	0.300		
Type 2 input (1)	16	2	2	No	0 or 24 V	–	Screw	ABE 7H16S21	0.375	
				Yes	0 or 24 V	–	Screw	ABE 7H16S21E	0.375	
	2	2	No	0 or 24 V	–	Screw	ABE 7H16R30	0.346		
			Yes	0 or 24 V	–	Screw	ABE 7H16R31	0.346		
	Input	16	2	1	Yes	24 V	I, F (2)	Screw	ABE 7H16S43	0.640
					Output	16	2	1	Yes	0 V

(1) For Modicon Premium.

(2) With LED to indicate blown fuse.



ABE 7H16R50



ABE 7H16R31

Connection interfaces

Advantys Telefast ABE 7 pre-wired system
Discrete input/output adaptation sub-bases
with soldered relays and removable terminal blocks

Adaptation sub-bases with soldered relays, removable terminal blocks

Input Universal sub-bases with solid state relays

No. of channels	No. of terminals per channel	Isolation PLC/Operative part	Voltage	Type of connection	Reference	Weight kg
16	2	Yes	--- 24 V	Screw	ABE 7S16E2B1	0.370
				Spring	ABE 7S16E2B1E	0.370
			--- 48 V	Screw	ABE 7S16E2E1	0.370
				Spring	ABE 7S16E2E1E	0.370
			~ 48 V	Screw	ABE 7S16E2E0	0.386
				Spring	ABE 7S16E2E0E	0.386
			~ 110 V	Screw	ABE 7S16E2F0	0.397
				Spring	ABE 7S16E2F0E	0.397
			~ 230 V	Screw	ABE 7S16E2M0	0.407
				Spring	ABE 7S16E2M0E	0.407

Output Universal sub-bases with solid state relays

No. of channels	Isolation PLC/Operative part	Output voltage	Output current	Fault detection signal (1)	Type of connection	Reference	Weight kg
8	No	--- 24 V	0.5 A	Yes (2)	Screw	ABE 7S08S2B0	0.252
					Spring	ABE 7S08S2B0E	0.252
			2 A	Yes (2)	Screw	ABE 7S08S2B1	0.448
					Spring	ABE 7S08S2B1E	0.448
16	No	--- 24 V	0.5 A	Yes (2)	Screw	ABE 7S16S2B0	0.405
					Spring	ABE 7S16S2B0E	0.405
			Non		Screw	ABE 7S16S1B2	0.400
					Spring	ABE 7S16S1B2E	0.400

Output Optimum & Universal sub-bases with electromechanical relays

No. of channels	Relay width	Number of contacts	Output current	Polarity distribution/operative part	Type of connection	Reference	Weight kg
8	5 mm	1 N/O	2 A	Contact common per group of 4 channels	Screw	ABE 7R08S111	0.252
					Spring	ABE 7R08S111E	0.252
		Latching	2 A	Volt-free	Screw	ABE 7R08S216	0.448
	Spring				ABE 7R08S216E	0.448	
	10 mm	1 N/O	5 A	Volt-free	Screw	ABE 7R08S210	0.448
					Spring	ABE 7R08S210E	0.448
16	5 mm	1 N/O	2 A	Contact common per group of 8 channels	Screw	ABE 7R16S111	0.405
					Spring	ABE 7R16S111E	0.405
		10 mm	1 N/O	5 A	Volt-free	Screw	ABE 7R16S210
	Spring					ABE 7R16S210E	0.405
	Common per group of 8 channels on both poles				Screw	ABE 7R16S212	0.400
					Spring	ABE 7R16S212E	0.400

(1) A fault on a sub-base output Qn will set PLC output Qn to safety mode, which will be detected by the PLC.

(2) Can only be used with modules with protected outputs.

816488



ABE 7R08S216

Connection interfaces

Advantys Telefast ABE 7 pre-wired system
Discrete input/output adaptation sub-bases
for or with plug-in relays

Adaptation sub-bases, for plug-in relays

Input Universal sub-bases for solid state relays (1)

No. of channels	No. of terminals per channel	For relay type	Isolation PLC/Operative part	Input connection	Type of connection	Reference	Weight kg
16	2	ABS 7E ABR 7 ABS 7S33E	Yes	Volt-free	Screw	ABE 7P16F310	0.850
					Spring	ABE 7P16F310E	0.850
					Polarity distribution	Screw	ABE 7P16F312

Output Optimum & Universal sub-bases with electromechanical relays (2)

No. of channels	Relay width	For relay type	No. and type of contacts	Polarity distribution/operative part	Reference	Weight kg	
16	5 mm	ABR 7S11	1 N/O	Contact common per group of 4 channels	ABE 7R16T111	0.600	
				Contact common per group of 4 output channels + 2 input common terminals	ABE 7R16M111 (3)	0.600	
				Volt-free	ABE 7R16T210	0.735	
	10 mm	ABR 7S21	1 N/O	1 N/O	Common on both poles (4)	ABE 7R16T212	0.730
					Volt-free	ABE 7R16T230	0.775
					Contact common (4)	ABE 7R16T231	0.730
12 mm	ABR 7S33	1 C/O	1 C/O	Volt-free	ABE 7R16T330	1.300	
				Common on both poles (5)	ABE 7R16T332	1.200	
				Volt-free	ABE 7R16T370	1.300	
		ABR 7S37	2 C/O	Volt-free	ABE 7R16T370	1.300	

816471



ABE 7R16M111

522345



ABE 7R16T210

(1) Not equipped with relays.

(2) Both technologies (electromechanical and solid state) may be combined on the same sub-base.

(3) 2 connection methods are available, enabling inputs and outputs to be connected to the same sub-base at the same time.

(4) Per group of 8 channels.

(5) Per group of 4 channels.

Connection interfaces

Advantys Telefast ABE 7 pre-wired system
Discrete output adaptation sub-bases
for plug-in relays

Adaptation sub-bases for plug-in relays (1)

Output Optimum & Universal sub-bases for solid state and/or with electromechanical relays (2)

No. of relay channels	Relay width	For relay type	Isolator per channel	Fuse per channel	Polarity distribution/operative part	Type of connection	Reference	Weight kg
16	5 mm	ABR 7S11 ABS 7SC1B	No	No	Contact common per group of 4 channels		ABE 7P16T111	0.550
							ABE 7P16M111 (2)	0.550
	10 mm	ABR 7S2● ABS 7SA2● ABS 7SC2● ABE 7ACC20	No	No	Volt-free	Screw	ABE 7P16T210 (3)	0.615
							ABE 7P16T230 (3)	0.655
						Spring	ABE 7P16T230E (3)	0.655
							ABE 7P16T214	0.675
	Yes	Volt-free	Screw	ABE 7P16T214	0.675			
	No	Common on both poles (4)	Screw	ABE 7P16T212	0.615			
	Yes	Common on both poles (4)	Screw	ABE 7P16T215	0.670			
8	12 mm	ABR 7S33 ABS 7A3● ABS 7SC3●● ABE 7ACC21	No	No	Volt-free	Screw	ABE 7P08T330	0.450
						Spring	ABE 7P08T330E	0.450
16	12 mm	ABR 7S33 ABS 7A3● ABS 7SC3●● ABE 7ACC21	No	No	Volt-free	Screw	ABE 7P16T330	0.900
						Spring	ABE 7P16T330E	0.900
						Common on both poles (5)	Screw	ABE 7P16T332
		ABR 7S33 ABS 7A3M ABS 7SC3E ABE 7ACC21	No	Yes	Volt-free	Screw	ABE 7P16T334	0.900
			Yes	Yes	Common on both poles (5)	Screw	ABE 7P16T318	1.000
						Spring	ABE 7P16T318E	1.000



ABE 7P16T210

(1) Not equipped with relays.

(2) 2 connection methods are available, enabling inputs and outputs to be connected to the same sub-base at the same time.

(3) With relay ABR 7S21 for sub-base ABE 7P16T210, with relay ABR 7S23 for sub-base ABE 7P16T230.

(4) Per group of 8 channels.

(5) Per group of 4 channels.

571192



ABS 7SC1B

Plug-in solid state relays

Relay width	Functions	Input circuit		Output circuit		Unit reference	Weight	
		Current	Nominal voltage	Current (1)	Nominal voltage			
5 mm	Output	---	24 V	2 A	--- 24 V	ABS 7SC1B	0.010	
10 mm	Output	---	24 V	0.5 A	--- 5...48 V	ABS 7SC2E	0.016	
					~ 24...240 V	ABS 7SA2M	0.016	
12 mm	Input	---	5 V TTL	–	--- 24 V	ABS 7EC3AL	0.014	
			24 V	–	--- 24 V	ABS 7EC3B2	0.014	
			Type 2	–	---			
			48 V	–	--- 24 V	ABS 7EC3E2	0.014	
			Type 2	–	---			
			~ 50 Hz	48 V	–	--- 24 V	ABS 7EA3E5	0.014
			~ 60 Hz	110...130 V	–	--- 24 V	ABS 7EA3F5	0.014
~ 50 Hz	230...240 V	–	--- 24 V	ABS 7EA3M5	0.014			
	Output	---	24 V	2 A	--- 24 V	ABS 7SC3BA	0.016	
				Self-protected	---			
				1.5 A	--- 5...48 V	ABS 7SC3E	0.016	
					~ 24...240 V	ABS 7SA3MA	0.016	

Plug-in electromechanical relays

Relay width	Control voltage	Output current (1)	Number of contacts	Sold in lots of	Unit reference	Weight
5 mm	--- 24 V	5 A (lth)	1 N/O	4	ABR 7S11	0.005
10 mm	--- 24 V	5 A (lth)	1 N/O	4	ABR 7S21	0.008
			1 C/O	4	ABR 7S23	0.008
12 mm	--- 24 V	10 A (lth)	1 C/O	4	ABR 7S33	0.017
		8 A (lth)	2 C/O	4	ABR 7S37	0.017
		--- 48 V	8 A (lth)	1 C/O	4	ABR 7S33E

Accessory

Description	Reference	Weight
Extractor for 5 mm miniature relays	ABE 7ACC12	0.010

(1) See characteristics table for specifications of relays in the sub-bases.

816476



ABR 7S2●

816474



ABR 7S3●

Connection interfaces

Advantys Telefast ABE 7 pre-wired system

Connection sub-bases

for counter and analogue channels



816478
ABE 7CPA01



ABE 7CPA412/410/21



816477
ABE 7CPA02

Connection sub-bases for counter and analogue channels

Functions	For Modicon PLCs	Compatible modules	Type of connection	Type of connection	Reference	Weight
			Telefast 2 side			kg
Counting and analogue	TSX Micro	Integrated analogue and counter TSX 37 22 TSX CTZ●A	15-way SUB-D	Screw	ABE 7CPA01	0.300
Counting, Axis control, Position control	Premium	TSX CTY●A TSX CAY●1	15-way SUB-D	Screw	ABE 7CPA01 (0.300
Parallel output absolute encoder connection	Premium	TSX CTY●A TSX CAY●1	15-way SUB-D	Screw	ABE 7CPA11	0.330
Distribution of 4 thermocouples	Modicon M340	BMX ART 0414 BMX ART 0814	25-way SUB-D	Screw	ABE 7CPA412	0.180
Distribution of 16 thermocouples	Premium	TSX AEY1614	25-way SUB-D	Screw	ABE 7CPA12	0.300
Passive distribution of 8 channels on screw terminal block with shielding continuity	Premium	TSX ASY810 TSX AEY1600 TSX A●Y800	25-way SUB-D	Screw	ABE 7CPA02	0.290
Distribution and supply of 4 analogue channels protected isolated	Modicon M340	BMX AMI 0410	25-way SUB-D	Screw	ABE 7CPA410	0.180
Distribution of 4 analogue output channels	Premium	TSX ASY410 TSX AEY420	25-way SUB-D	Screw	ABE 7CPA21	0.180
Distribution and supply of 8 analogue channels with limitation of each current loop	Premium	TSX AEY800 TSX AEY1600	25-way SUB-D	Screw	ABE 7CPA03	0.330
Distribution and supply of 8 analogue input channels isolated from each other with 25 mA/ channel limiter	Premium	TSX AEY810	25-way SUB-D	Screw Spring	ABE 7CPA31 ABE 7CPA31E	0.410 0.410
Safety	Premium	TSX PAY2●2	25-way SUB-D	Screw	ABE 7CPA13	0.290

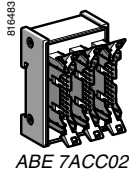

ABE 7ACC02

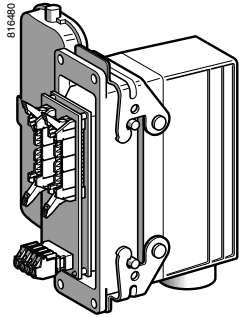

ABE 7ACC80 + ABE 7ACC81

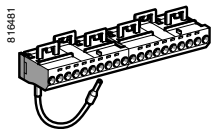

ABE 7BV20

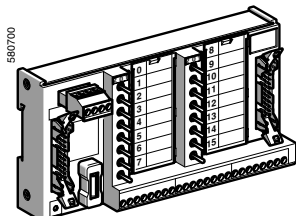

ABE 7TES160

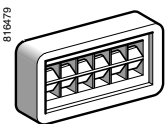

AR1 SB3

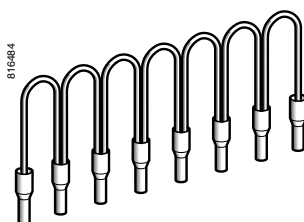
ABE C08R...
5

Software

Description	Operating system	Reference	Weight kg
Software for marking customer labels	Under Windows version 3.1 or 95	ABE 7LOGV10	0.350
Pack of 25 pre-cut label sheets (160 labels)	–	ABE 7LOGF25	0.200

Accessories

Description	No. of channels	Characteristics	Sold in lots of	Unit reference	Weight kg
Kit for mounting on solid plate	–	–	10	ABE 7ACC01	0.008
Splitter sub-base	–	16 as 2 x 8 channels	1	ABE 7ACC02	0.075
Redundant output sub-base	–	16 as 2 x 16 channels	1	ABE 7ACC10	0.075
Redundant input sub-base	–	16 as 2 x 16 channels	1	ABE 7ACC11	0.075
Plug-in continuity blocks	–	Width 10 mm	4	ABE 7ACC20	0.007
		Width 12 mm	4	ABE 7ACC21	0.010
Locating device for removable terminal block	–	–	100	ABE 7ACC30	0.100
Enclosure feedthrough with industrial connector	32	40-way	1	ABE 7ACC80	0.300
Plug-in 40-way male connector	32	For mounting on ABE 7ACC80	1	ABE 7ACC81	0.370
Enclosure feedthrough with CNOMO M23 connector (1 x 20-way HE 10 connector, PLC end)	16	19-way	1	ABE 7ACC82	0.150
		8 and 12	19-way	1	ABE 7ACC83
Impedance adapter for Type 2 compatibility	–	Used with ABE 7ACC82 and ABE 7ACC83	1	ABE 7ACC85	0.012
IP 65 cable gland	–	For 3 cables	5	ABE 7ACC84	0.300
Additional snap-on terminal blocks (shunted terminals)	8	10 screw terminals	5	ABE 7BV10	0.030
		10 spring terminals	5	ABE 7BV10E	0.030
		16	20 screw terminals	5	ABE 7BV20
		20 spring terminals	5	ABE 7BV20E	0.060
I/O simulator sub-base	16	Display, forcing inhibition, continuity	1	ABE 7TES160	0.350
Self-adhesive marker tag holder	–	For 6 characters	50	AR1 SB3	0.001
Quick-blow fuses 5 x 20, 250 V, UL	–	0.125 A	10	ABE 7FU012	0.010
		0.5 A	10	ABE 7FU050	0.010
		1 A	10	ABE 7FU100	0.010
		2 A	10	ABE 7FU200	0.010
		4 A	10	ABE 7FU400	0.010
		6.3 A	10	ABE 7FU630	0.010

Commoning link accessories

Description	For common	Colour	Distance between cable ends cm	Reference	Weight kg
Commoning links Modularity 8 x 1 mm ²	Coil	White	12	ABF C08R12W	0.020
			2	ABF C08R02W	0.010
	~	Red	12	ABF C08R12R	0.020
			2	ABF C08R02R	0.010
	---	Blue	12	ABF C08R12B	0.020
			2	ABF C08R02B	0.010

Connection interfaces

Advantys Telefast ABE 7 pre-wired system

Common side view

ABE 7H20E●●●
ABE 7H32E●●●

ABE 7H16C●●/ABE 7H16CM●●,
ABE 7●16M111/ABE 7●16T111

ABE 7H16R50, ABE 7H12R50,
ABE 7H08R1●, ABE 7H08R21,
ABE 7R08S111/S111E,
ABE 7H08S21, ABE 7CPA21/40/412

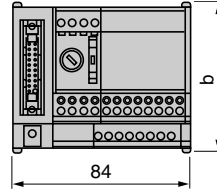
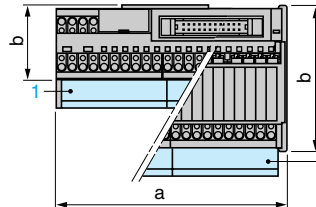
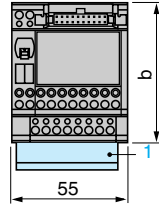
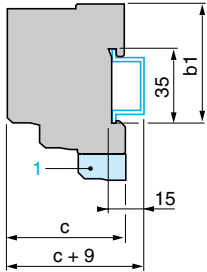

ABE	7H20E/7H32E●●●
b	67
b1	56
c	59

ABE	7H16C●●, 7●16M111, 7H16CM●●	7●16T111
a	106	110
b	49	89
b1	41.5	58
c	60	54

ABE	7H16/12/08●●●	7R08S111●	7CPA21/410/412
b	70	77	
b1	58	58	
c	58	58	

1 Additional shunt terminal block ABE 7BV10/7BV20

Common side view

ABE 7H16R2●, ABE 7H12R2●, ABE 7H16R3●,
ABE 7H16R1●, ABE 7H12R1●, ABE 7H12S21,
ABE 7H16S2●, ABE 7R16S11●, ABE 7R08S210,
ABE 7S08S2B0, ABE 7CPA02, ABE 7CPA03
ABE 7S16S1B2, ABE 7R08S216

ABE 7R16S21●, ABE 7H16●43
ABE 7S16S2B0/S2B02E,
ABE 7S16E2●●/S16E2●●E,
ABE 7S08S2B1/S08S2B1E
ABE 7CPA31

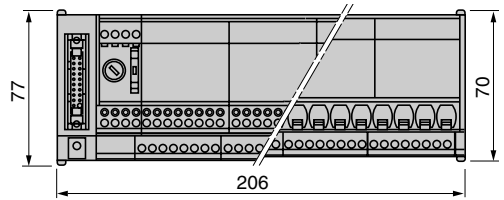
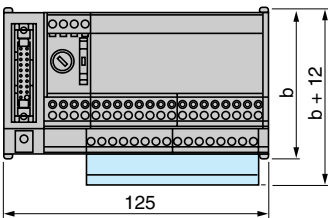
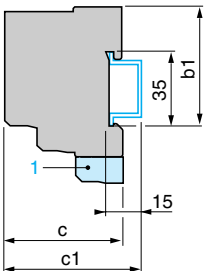

ABE	7●●●●●	7●R08S210●, 7S16S1B2●, 7R08S216
b	70	77
b1	58	58
c	58	58

All sub-bases	
b1	
c	58

1 Additional shunt terminal block ABE 7BV10/7BV20

Common side view

ABE 7R16T2●●, ABE 7P16T2●●

ABE 7CPA01, ABE 7CPA11/CPA12/CPA13

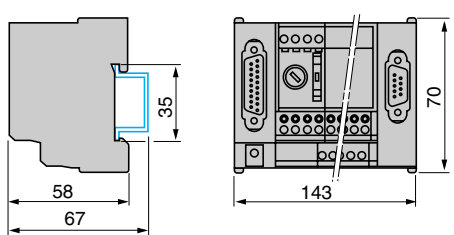
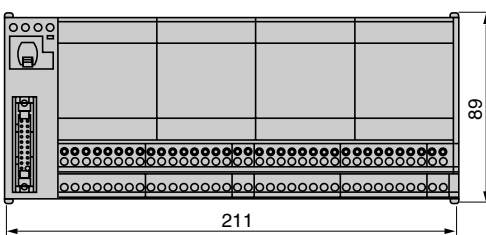
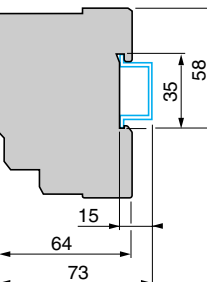

Common side view

ABE 7R16T3●●, ABE 7P16T3●●, ABE 7P16F31●

ABE 7P08T330

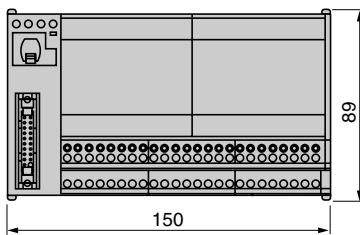
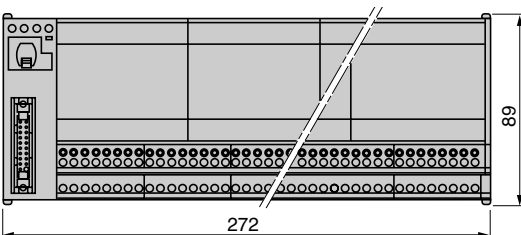
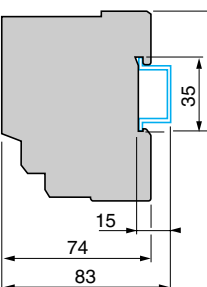

Note : details of the front view are the same as for the ABE 7CPA01.

ABE 7ACC02

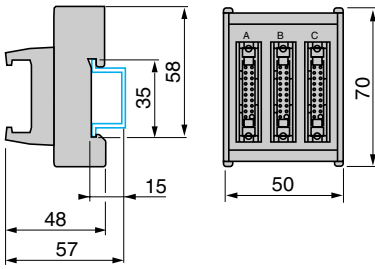

ABE 7ACC03

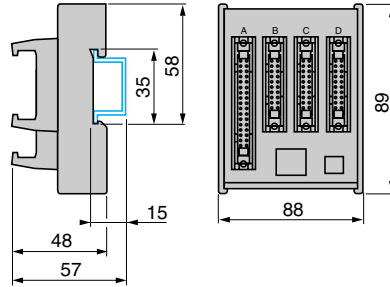

ABE 7ACC04, ABE 7ACC05
ABE 7ACC10, ABE 7ACC11

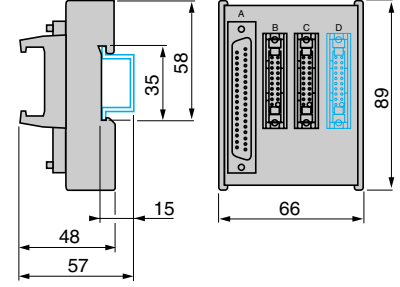

Note : Drawing representing ABE 7ACC04 and ABE 7ACC05

ABE 7ACC80

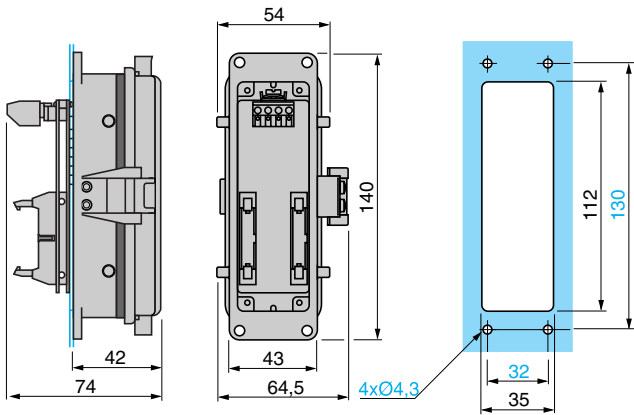

ABE 7ACC82, ABE 7ACC83

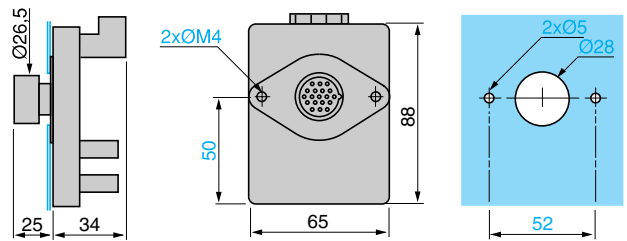

ABE 7ACC84

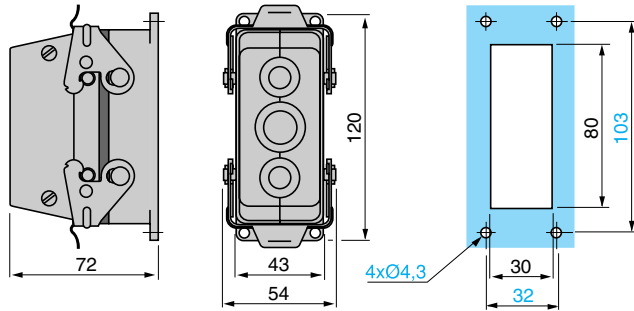

ABE 7TES160

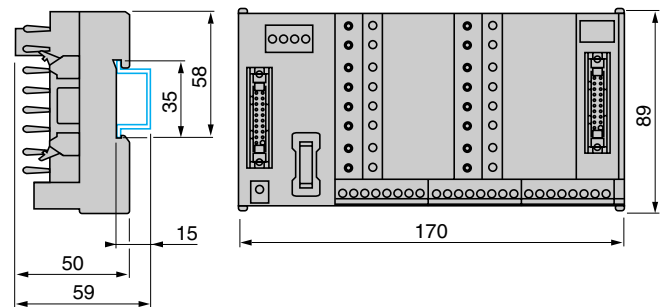

Fixing centres for sub-bases using mounting kit ABE 7ACC01

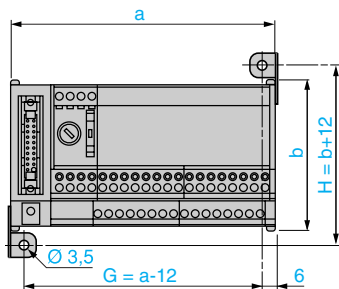

ABE 7	G	H
ACC02	38	82
ACC03	53	101
ACC04	53	101
ACC05	53	101
ACC10/11	53	101
H08R●●	72	82
H08S21	72	82
H12R50	72	82
H16R50	72	82
R08S111	72	82
CPA01	131	82
CPA02	113	82
CPA1●	131	82
CPA03	113	82

ABE 7	G	H
H12R1●	113	82
H12R2●	113	82
H16R1●	113	82
H16R2●	113	82
H16R3●	113	82
H12S21	113	82
H16S21	113	82
R08S210	113	82
R16S111	113	82
R16S21●	194	82
S08S2B0	113	82
S08S2B1	194	82

ABE 7	G	H
H16F43	194	82
H16S43	194	82
S16E2●●	194	82
S16S1B2	113	82
S16S2●●	194	82
R16T2●●	199	101
P16T2●●	199	101
R16T3●●	260	101
P08T330	150	101
P16T3●●	260	101
P16F3●●	260	101

6 - Technical information

- Standards, certifications, and environmental conditions page 6/2
- Automation product certifications and community regulations page 6/6
- Power consumption table page 6/8

Index

- Product reference index page 6/9

Modicon M340 automation platform

Standards, certifications and environment conditions

Standards and certifications

Modicon M340 PLCs have been developed to conform to the principal national and international standards concerning electronic equipment for industrial automation systems.

- Requirements specific to programmable controllers: functional characteristics, immunity, resistance, safety, etc.: IEC/EN 61131-2, CSA 22.2 N° 142, UL 508.
- Merchant navy requirements of the main international bodies (with ABS, BV, DNV, GL, LR, RINA, RMRS): IACS (*International Association of Classification Societies*)
- Compliance with European Directives:
 - Low Voltage: 73/23/EEC amendment 93/68/EEC,
 - Electromagnetic Compatibility: 89/336/EEC amendments 92/31/EEC and 93/68/EEC.
- Electrical qualities and self-extinguishing capacity of insulating materials: UL 746C, UL 94.
- Hazardous areas classification: CSA 22.2 No. 213, Class I, Division 2, Groups A, B, C and D.

Characteristics

Service conditions and recommendations relating to environment

Temperature	Operation	° C	0...+ 60			
	Storage	° C	- 40...+ 85			
Relative humidity	Operation	%	93...95 without condensation according to IEC/EN 60060-2-30 Db			
	Storage	%	93...95 without condensation according to IEC/EN 60060-2-30 Db			
Altitude		m	0...4000, temperature derating from 3000 m: 1 °C/400 m, equals to + 55 °C at 4000 m			
Supply voltage			BMX CPS 2010	BMX CPS 3020	BMX CPS 2000	BMX CPS 3500
~: according to IEC/EN 61131-2	Nominal voltage	V	--- 24	--- 24...48	~ 100...240	~ 100...240
	Limit voltages		--- 18...31.2	--- 18...62.4	~ 85...264	~ 85...264
---: according to IACS E10 battery without charge	Nominal frequencies	Hz	–	–	50/60	50/60
	Limit frequencies	Hz	–	–	47/63	47/63

Protective treatment of Modicon M340 PLCs

Premium/Atrium PLCs meet the requirements of "TC" treatment (*Treatment for all Climates*).

For installations in industrial production workshops or environments corresponding to "TH" treatment (*treatment for hot and humid environments*), Premium PLCs must be embedded in envelopes with a minimum IP 54 protection, in compliance with IEC/EN 60664 and NF C 20 040.

Premium/Atrium PLCs themselves offer **protection to IP 20 level** and **protection against pins** (enclosed equipment) (1). They can therefore be installed without an envelope in reserved-access areas which do not exceed **pollution level 2** (control room with no dust-producing machine or activity). The pollution level 2 does not take account of more severe environmental conditions: air pollution by dust, smoke, corrosive or radioactive particles, vapours or salts, attack by fungi, insects, ...

(1) In the case where a position is not occupied by a module, a **BMX XEM 010** protection cover must be installed.

Environment tests

Immunity to LF interference (CE) (1)

Name of test	Standards	Levels
Voltage and frequency variation	IEC/EN 61000-4-11 IACS E10 / IEC 60092-504	0.9 Un/0.95 Fn for 30 minutes; 1.10 Un/1.05 Fn for 30 minutes; 0.8 Un/0.9 Fn for 1,5/5 seconds; 1.2 Un/1.1 Fn for 1,5/5 seconds
Direct voltage variation	IEC/EN 61131-2 IEC/EN 61000-4-11 IEC 60092-504 IACS E10 (battery without charge)	0.85 Un...1.2 Un for 30 minutes with 5% ripple (peak values)
Harmonic 3	IEC/EN 61131-2	10 % Un; 0° for 5 min...180° for 5 min
Inter harmonic	IACS E10 / IEC 60092-504	H2...H200 - 10 % (H15), - 10 %...1 % (H15...H100) and 1 % (H100...H200)
Short momentary interrupt	IEC/EN 61131-2 IEC/EN 61000-4-11/-6-2	10 ms with ~ supply; 1 ms with --- supply
Voltage shut-down/start-up	IEC/EN 61131-2	Un-0-Un; Un for 60 s; 3 cycles separated by 10 s Un-0-Un; Un for 5 s; 3 cycles separated by 1 to 5 s Un-0.9-Udl; Un for 60 s; 3 cycles separated by 1 to 5 s

Where:
Un: nominal voltage
Fn: nominal frequency
Udl: detection level when powered

Immunity to HF interference. (CE) (1)

Name of test	Standards	Levels
Damped oscillatory wave	IEC/EN 61000-4-12 IEC/EN 61131-2 Zone C	~ / --- main supply, ~ auxiliary supply, discrete ~ I/O (unshielded): 2.5 kV in commun mode, 1 kV in differential mode --- auxiliary supply, discrete ~ I/O (unshielded) and analogue I/O: 1 kV in commun mode, 0.5 kV in differential mode All shielded cable: 0.5 kV in commun mode
Electrical fast transient bursts	IEC/EN 61000-4-4 IACS E10 / IEC 61131-2	~ / --- main and auxiliary supplies, discrete ~ I/O (unshielded): 2 kV in wire mode, 2 kV in common mode Discrete --- I/O (unshielded), analogue I/O and all shielded cable: 1 kV in common mode
Surge	IEC/EN 61000-4-5 IEC/EN 61131-2 Zone B IACS E10	~ / --- main and auxiliary supplies, discrete ~ I/O (unshielded): 2 kV in commun mode, 1 kV in differential mode Discrete ~ I/O (unshielded) and analogue I/O: 0.5 kV in wire mode, 0.5 kV in differential mode All shielded cable: 1 kV in commun mode
Electrostatic discharges	IEC/EN 61000-4-2 IEC/EN 61131-2 Zone B IACS E10	6 kV contact, 8 kV air
Radiated electromagnetic field	IEC/EN 61000-4-3	15 V/m : 80 MHz...2 GHz Sinusoidal modulation amplitude 80 % / 1 kHz + internal clock frequency
Conducted interference induced by radiated field	IEC/EN 61000-4-6 IEC/EN 61131-2 IACS E10	10 V : 0,15 MHz...80 MHz Sinusoidal modulation amplitude 80% / 1 kHz + spot frequency

Electromagnetic emissions (CE) (1) (2)

Name of test	Standards	Levels
Interference voltage	EN 55011, Classe A IEC/EN 61131-2 IEC/EN 61000-6-4 FCC part 15 IACS E10	150 kHz...500 kHz quasi-peak 79 dB (µV); average 66 dB (µV) 500 kHz...30 MHz quasi-peak 73 dB (µV); average 60 dB (µV)
Interference field	EN 55011, Classe A IEC/EN 61131-2 IEC/EN 61000-6-4 FCC part 15 IACS E10	Values according general power distribution zone 30 MHz...230 MHz: quasi-peak 40 dB (measurement at 10 m), quasi-peak 50 dB (measurement at 3 m) 230 MHz...2 GHz: quasi-peak 47 dB (measurement at 10 m), quasi-peak 57 dB (measurement at 3 m) Values depending on general power distribution zone

(1) Devices must be installed and wired in compliance with the instructions provided in the **UNY USE 10010 V11E** manual "Grounding and cabling system intallation guide".

(2) These tests are performed without a cabinet, with devices **fixed on a metal grid** and wired as per the recommendations in the industrial **UNY USE 10010 V11E** manual "Grounding and cabling system intallation guide".

(CE): tests required by European directives CE. and based on IEC / EN 61131-2 standards.

Environment tests (continued)

Immunity to climatic variations

Name of test	Standards	Levels
Dry heat	IEC/EN 60068-2-2 Bd IACS E10	60 ° C for 16 hours
Cold	IEC/EN 60068-2-1 Ab & Ad IEC/EN 60068-2-48	0 ° C for 16 hours with start at 0 ° C
Continuous humid heat	IEC/EN 60068-2-78 Ca	60 ° C with 93 % relative humidity for 96 hours
Cyclical humid heat	IEC/EN 60068-2-3 Db	55 ° C, 25 ° C with 93...95 % relative humidity with 2 cycles of 12 hours/12 hours
Cyclical temperature variations	IEC/EN 60068-2-14 Nb	0 ° C...60 ° C with 5 cycles of 6 hours/6 hours
Temperature Rise	IEC/EN 61131-2/UL 508 CSA 22-2 No.142	Ambient temperature: 60 ° C

Withstand to climatic variations

Name of test	Standards	Levels
Dry heat (power off)	IEC/EN 60068-2-2 Bb & Bd	85 ° C for 96 hours
Cold (power off)	IEC/EN 60068-2-1 Ab & Ad IEC/EN 60068-2-48	- 40 ° C for 96 hours
Humid heat (power off)	IEC/EN 60068-2-30 dB	25 °...60 ° C with 93...95 % relative humidity with 2 cycles of 12 hours/12 hours
Heat shocks (power off)	IEC/EN 60068-2-14 Na & Nb	- 40 ° C...85 ° C with 2 cycles of 3 hours/3 hours

Environment tests (continued)

Immunity to mechanical constraints (1) (power on)

Name of test	Standards	Levels
Sinusoidal vibrations	IEC/EN 60068-2-6 Fc	3 Hz...100 Hz/1 mm amplitude/0.7 g, transition frequency 13.2 Hz Endurance to resonance frequency 90 min/axis Application coefficient < 10
Sinusoidal vibrations (Class 3M7)	IEC/EN 61131-2	5...150 Hz with 10 mm amplitude / 3 g, transition frequency 9 Hz Endurance: 10 cycles of 1 octave/min
Shocks	IEC/EN 60068-2-27 Ea	30 g - 11 ms; 3 shocks/direction/axis
Bumps	IEC/EN 60068-2-29 Eb	25 g - 6 ms; 50 bumps/direction/axis
Plugging / unplugging	IEC/EN 61131-2 (6.2.5)	For modules and connectors 50 operations for permanent connections 500 operations for non permanent connections

Withstand to mechanical constraints (power off)

Name of test	Standards	Levels
Vibrations	IEC/EN 60068-2-6 Fc	5...150 Hz with 15 mm amplitude / 5 g, transition frequency 9 Hz Endurance: 10 cycles of 1 octave/min
Shocks	IEC/EN 60068-2-27 Ea and specific profil	50 g - 11 ms; 3 shocks/direction/axis
Bumps	IEC/EN 60068-2-29 Eb	25 g - 6 ms; 500 bumps/direction/axis
Flat freefall	IEC/EN 60068-2-32 Ed method 1	10 cm / 2 falls
Controlled position freefall (for handheld product)	IEC/EN 60068-2-31 Ec	30 ° or 10 cm / 2 falls
Random freefall (equipment in packaging)	IEC/EN 60068-2-32 method 1	1 m / 5 falls

Equipment and personnel safety (1) (CE)

Name of test	Standards	Levels
Dielectric strength	UL 508/CSA 22-2 No.142 FM IEC/EN 61131-2	2 Un + 1000 V / 1 min
Insulation resistance	UL 508/CSA 22-2 No.142 FM IEC/EN 61131-2	Un ≤ 50 V: 10 MΩ 50 V ≤ Un ≤ 250 V: 10 MΩ
Continuity of earth	UL 508/CSA 22-2 No.142 FM IEC/EN 61131-2	30 A for 2 min, R < 0,1 Ω
Leakage current	IEC/EN 61131-2	I < 3.5 mA after disconnecting
Protection offered by enclosures	IEC/EN 61131-2	IP 20 and protection against standardize pins
Withstand to impacts	UL 508/CSA 22-2 No.142 FM IEC/EN 61131-2	500 g sphere: fall from 1.3 m
Stored energy injury risk	IEC/EN 61131-2	After 10 s, max. 37 % Un
Overload	UL 508/CSA 22-2 No.142 FM IEC/EN 61131-2	50 cycles 1 s / 9 s to Un and 1.5 In
Endurance	UL 508/CSA 22-2 No.142 FM IEC/EN 61131-2	12 cycles 100 ms / 100ms, 988 cycles 1 s / 1 s and 5000 cycles 1 s / 9s to Un and In
Temperature rise	IEC/EN 61131-2/UL 508 CSA 22-2 No.142/UL 1604 CSA 22-2 No.213/FM	Ambient temperature 60 ° C

(1) Devices must be installed, wired and maintained in compliance with the instructions provided in the user's manual.

(2) These tests are performed without a cabinet, with devices **fixed on a metal grid** and wired as per the recommendations in the industrial **UNY USE 10010 V11E** manual "Grounding and cabling system installation guide".

(CE): tests required by European directives CE and based on IEC / EN 61131-2 standards.

Technical information

Automation products certifications









In some countries, certification of certain electrical components is enforced by law. A standard conformity certificate is then issued by the official organization. Each certified product must carry approval symbols when enforced. Use on board merchant navy vessels generally requires prior approval (= certification) of an electrical device by certain marine classification authorities.

Key	Certification body	Country
CSA	Canadian Standards Association	Canada
C-Tick	Australian Communication Authority	Australia
GOST	Gost Standard Scientific Research Institute	C.I.S., Russia
UL	Underwriters Laboratories	USA
Key	Classification authority	Country
IACS	International Association of Classification Societies	International
ABS	American Bureau of Shipping	USA
BV	Bureau Veritas	France
DNV	Det Norske Veritas	Norway
GL	Germanischer Lloyd	Germany
LR	Lloyd's Register	United Kingdom
RINA	Registro Italiano Navale	Italy
RMRS	Russian Maritime Register of Shipping	C.I.S.

The table below shows the situation as at 01.10.2006 for certifications obtained or pending from organizations for base PLCs. An overview of certificates for Telemecanique products is available on our Internet website:

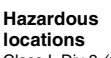
www.telemecanique.com

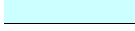
Product certifications

	Approvals					
	 UL USA	 CSA Canada	 ACA Australia	 GOST CIS, Russia	 Hazardous locations Class I, Div 2 (1) USA, Canada	 ATEX Europe
 <i>Certified</i>						
 <i>Pending certification</i>						
Advantys STB					FM	
Advantys Telefast ABE 7						
ConneXium					(2)	
Magelis iPC	(3)				UL	
Magelis XBT GT						Cat 3 G-D
Magelis XBT F/FC/HM/PM						
Magelis XBT N/R					CSA/UL	Cat 3 G-D
Modicon M340					CSA	
Modicon Momentum						
Modicon Premium				(2)	CSA	
Modicon Quantum				(2)	FM (2)	
Modicon TSX Micro						
Twido	(3)	(2)			UL (2)	

(1) **Hazardous locations:** UL 1604, CSA 22.2 no. 213 or FM 3611, certified products are acceptable for use in hazardous locations of Class I, division 2, groups A, B, C and D or unclassified only.

(2) Depending on product, consult our website: www.telemecanique.com

(3) **cULus** North American certification (Canada and USA).

Local certifications







BG	Germany	TSX DPZ 10D2A safety module (TSX Micro). TSX PAY 262/282 safety modules (Premium).
SIMTARS	Australia	Modicon TSX Micro automation platform Modicon Premium automation platform (PL7)
AS-Interface	Europe	TWD NOI 10M3 master module (Twido). TSX SAZ 10 master module (TSX Micro). TSX SAY 1000 master modules (Premium).

Technical information

Automation products certifications

Community regulations

Marine classification

	Marine classification authorities						
	 ABS	 BV	 DNV	 GL	 LR	 RINA	 RMRS
	USA	France	Norway	Germany	UK	Italy	C.I.S.
Advantys STB	(1)						
Advantys Telefast ABE 7							
ConneXium				(2)			
Magelis iPC							
Magelis XBT GT							
Magelis XBT F/FC/HM/PM							
Magelis XBT N/R							
Modicon M340	(3)						
Modicon Momentum							
Modicon Premium (4)	(2)	(2)	(2)	(2)	(2)	(2)	(2)
Modicon Quantum				(2)		(2)	
Modicon TSX Micro							
Twido			(2)	(2)	(2)		

(1) Also meets US Navy requirements, **ABS-NRV** part 4.

(2) Depending on product, consult our website: www.telemecanique.com.

(3) Request for Marine certifications forecast 1st quarter of 2007.

(4) Modicon Premium, also **KRS** (Korean register of Shipping) certified.

Community regulations

European directives

The opening of European markets implies a harmonization of regulations in the various European Union member states.

European Directives are documents used to remove obstacles to the free movement of goods and their application is compulsory in all states of the European Union.

Member states are obliged to transcribe each Directive into their national legislation and, at the same time, to withdraw any conflicting regulations.

The Directives, particularly those of a technical nature with which we are concerned, only set objectives, called "general requirements".

The manufacturer must take all necessary measures to ensure that his products conform to the requirements of each Directive relating to his equipment.

As a general rule, the manufacturer affirms that his product conforms to the necessary requirements of the Directive(s) by applying the CE label to his product.

The CE marking is applied to Telemecanique products where relevant.

The significance of CE marking

- The CE marking on a product means that the manufacturer certifies that his product conforms to the relevant European Directives; it is necessary in order that a product which is subject to a Directive(s) can be marketed and freely moved within the European Union.
- The CE marking is intended solely for the national authorities responsible for market regulation.

For electrical equipment, conformity of the product to standards indicates that it is suitable for use. Only the guarantee of a recognized manufacturer provides an assurance of high quality.

One or more Directives, as appropriate, may apply to our products, in particular:

- The Low Voltage Directive 72/23/EEC amended by Directive 93/68/EEC: The CE marking under the terms of this Directive is compulsory as of January 1, 1997.
- The Electromagnetic Compatibility Directive 89/336/EEC, amended by Directives 92/31/EEC and 93/68/EEC: The CE marking on the products covered by this Directive has been compulsory since January 1, 1996.
- Directive CE ATEX 94/9/EC.

Modicon M340 automation platform

Power consumption table (specimen to be photocopied)

The power required to supply each **BMX XBP ●●●0** rack depends on the type and number of modules installed. It is therefore necessary to create a power consumption table for each rack in order to define the most suitable **BMX CPS ●●●0** power supply module for each rack. The table below can be used to calculate the consumption on the 2 or 3 different voltages (depending on model) to be supplied by the **BMX CPS ●●●0** power supply module: --- 3,3 V, --- 24 V rack, --- 24 V sensors.

Procedure:

- Check and choose a power supply module corresponding to the power supplies available for the 2 or 3 voltages.
- Check that the total power absorbed on these three voltages does not exceed the overall power of the power supply module.
- Values to be entered according to the type of Modicon M340 configuration.

Rack n°	Module reference	Format S: standard D: double	Number	Consumption in mA						
				Voltage --- 3,3 V		Voltage --- 24 V rack		Voltage --- 24 V sensors		
				Module	Total	Module	Total	Module	Total	
Processors	BMX P34 1000	S	1			72				
	BMX P34 2010	S				90				
	BMX P34 2020	S				95				
	BMX P34 2030	S				135				
Discrete I/O	BMX DAI 1602	S		90						
	BMX DAI 1603	S		90						
	BMX DAI 1604	S		90						
	BMX DAO 1605	S		100		A définir				
	BMX DDI 1602	S		90				60		
	BMX DDI 1603	S		90						
	BMX DDI 3202K	S		140					110	
	BMX DDI 6402K	S		200					110	
	BMX DDM 16022	S		100					30	
	BMX DDM 16025	S		100		50			30	
	BMX DDM 3202K	S		150					55	
	BMX DDO 1602	S		100						
	BMX DDO 1612	S		100						
	BMX DDO 3202K	S		150						
	BMX DDO 6402K	S		240						
	BMX DRA 0805	S		100		55				
	BMX DRA 1605	S		100		95				
Analogue I/O	BMX AMI 0410	S		150		45				
	BMX AMM 0600	S		150		130				
	BMX AMO 0210	S		150		110				
	BMX ART 0414	S		150		40				
	BMX ART 0814	S		150		100				
Counting	BMX EHC 0200	S		200		40		80		
	BMX EHC 0800	S		200				80		
Communication	BMX NOE 0100	S				90				
Consumption per voltage				Total current (mA) <input type="text"/> x 3,3 V + <input type="text"/> x 24 V + <input type="text"/> x 24 V = <input type="text"/> Consumption voltage (mW) <input type="text"/> + <input type="text"/> + <input type="text"/> = <input type="text"/>  Power available (mW) <input type="text"/> Power overall (mW) <input type="text"/>						
Choice of power supply	BMX CPS 2010	D	--- 24 V isolated	8250		16 800				17 000
	BMX CPS 3020	D	--- 24...48 V isolated	14850		31 200				32 000
	BMX CPS 2000	D	~ 100...240 V	8250		16 800		10 800		20 000
	BMX CPS 3500	D		14850		31 200		21 600		36 000

6

1		ABE 7H12R10	5/11	ABE 7S08S2B1	5/12	BMX FCA300	2/31	FTX CN 12F5	3/40
110 XCA 282 01	4/31	ABE 7H12R11	5/11	ABE 7S08S2B1E	5/12	BMX FCA302	2/31	FTX CN 12M5	3/40
110 XCA 282 02	4/31	ABE 7H12R20	5/11	ABE 7S16E2B1	5/12	BMX FCA500	2/31	FTX CN 3130	3/40
110 XCA 282 03	4/31	ABE 7H12R21	5/11	ABE 7S16E2B1E	5/12	BMX FCA502	2/31	FTX CN 3150	3/40
		ABE 7H12R50	5/11	ABE 7S16E2E0	5/12	BMX FCC 051	2/17	FTX CN 3203	3/40
4		ABE 7H12S21	5/11	ABE 7S16E2E0E	5/12	BMX FCC 053	2/17	FTX CN 3206	3/40
490 NOC 000 05	3/34	ABE 7H16C10	5/10	ABE 7S16E2E1	5/12	BMX FCC 1001	2/17	FTX CN 3210	3/40
490 NOR 000 03	3/34	ABE 7H16C11	5/10	ABE 7S16E2E1E	5/12	BMX FCC 1003	2/17	FTX CN 3220	3/40
490 NOR 000 05	3/34	ABE 7H16C21	5/10	ABE 7S16E2F0	5/12	BMX FCC 101	2/17	FTX CN 3230	3/40
490 NOR 000 15	3/34	ABE 7H16C31	5/10	ABE 7S16E2F0E	5/12	BMX FCC 103	2/17	FTX CN 3250	3/40
490 NOT 000 05	3/34	ABE 7H16CM11	5/10	ABE 7S16E2M0	5/12	BMX FCC 201	2/17	FTX CNCT1	3/41
490 NTC 000 05	3/34	ABE 7H16CM21	5/10	ABE 7S16E2M0E	5/12	BMX FCC 203	2/17	FTX CNTL12	3/41
490 NTC 000 05U	3/34	ABE 7H16F43	5/11	ABE 7S16S1B2	5/12	BMX FCC 301	2/17	FTX CY1208	3/41
490 NTC 000 15	3/34	ABE 7H16R10	5/11	ABE 7S16S1B2E	5/12	BMX FCC 303	2/17	FTX CY1212	3/41
490 NTC 000 15U	3/34	ABE 7H16R11	5/11	ABE 7S16S2B0	5/12	BMX FCC 501	2/17	FTX DG12	3/41
490 NTC 000 40	3/34	ABE 7H16R11E	5/11	ABE 7S16S2B0E	5/12	BMX FCC 503	2/17	FTX DP2115	3/41
490 NTC 000 40U	3/34	ABE 7H16R20	5/11	ABE 7TES160	5/17	BMX FCW 1001	2/17	FTX DP2130	3/41
490 NTC 000 80	3/34	ABE 7H16R21	5/11	ABF C08R02B	5/17	BMX FCW 1003	2/17	FTX DP2150	3/41
490 NTC 000 80U	3/34	ABE 7H16R21E	5/11	ABF C08R02R	5/17	BMX FCW 301	2/17	FTX DP2206	3/41
490 NTW 000 02	3/34	ABE 7H16R23	5/11	ABF C08R02W	5/17	BMX FCW 301S	2/31	FTX DP2210	3/41
490 NTW 000 02U	3/34	ABE 7H16R30	5/11	ABF C08R12B	5/17	BMX FCW 303	2/17	FTX DP2220	3/41
490 NTW 000 05	3/34	ABE 7H16R31	5/11	ABF C08R12R	5/17	BMX FCW 501	2/17	FTX DP2250	3/41
490 NTW 000 05U	3/34	ABE 7H16R50	5/11	ABF C08R12W	5/17	BMX FCW 501S	2/31	FTX MLA10	3/41
490 NTW 000 12	3/34	ABE 7H16R50E	5/11	ABR 7S11	5/15	BMX FCW 503	2/17		
490 NTW 000 12U	3/34	ABE 7H16S21	5/11	ABR 7S21	5/15	BMX FTB 2000	2/17,		
490 NTW 000 40	3/34	ABE 7H16S21E	5/11	ABR 7S23	5/15		2/31 and	LU9 GC3	3/44
490 NTW 000 40U	3/34	ABE 7H16S43	5/11	ABR 7S33	5/15		2/41		
490 NTW 000 80	3/34	ABE 7H20E100	5/10	ABR 7S33E	5/15	BMX FTB 2010	2/17,	S	
490 NTW 000 80U	3/34	ABE 7H20E200	5/10	ABR 7S37	5/15		2/31 and	STB XSP 3010	1/15
		ABE 7H20E300	5/10	ABS 7EA3E5	5/15		2/41	STB XSP 3020	1/15
		ABE 7H32E150	5/10	ABS 7EA3F5	5/15	BMX FTB 2020	2/17,		
		ABE 7H32E300	5/10	ABS 7EA3M5	5/15		2/31 and		
9		ABE 7LOGF25	5/17	ABS 7EC3AL	5/15		2/41	T	
990 NAA 263 20	4/31	ABE 7LOGV10	5/17	ABS 7EC3B2	5/15	BMX FTW 1001	2/17	TCS CCE 4F3M05	3/40
990 NAA 263 50	4/31	ABE 7P08T330	5/14	ABS 7EC3E2	5/15	BMX FTW 301	2/17	TCS CCE 4F3M1	3/40
		ABE 7P08T330E	5/14	ABS 7SA2M	5/15	BMX FTW 301S	2/31	TCS CCU 4F3M1	3/40
A		ABE 7P16F310	5/13	ABS 7SA3MA	5/15	BMX FTW 501	2/17	TCS CCU4F3M05	3/40
ABE 7ACC01	5/17	ABE 7P16F310E	5/13	ABS 7SC1B	5/15	BMX FTW 501S	2/31	TCS CTN011M11F	3/41
ABE 7ACC02	5/17	ABE 7P16T111	5/14	ABS 7SC2E	5/15	BMX NOE 0100	3/23	TCS EAA F11F13F00	3/35
ABE 7ACC10	5/17	ABE 7P16T1210	5/14	ABS 7SC3BA	5/15	BMX P34 1000	1/9 and	TCS EAA F1LFS00	3/35
ABE 7ACC11	5/17	ABE 7P16T212	5/14	ABS 7SC3E	5/15		3/43	TCS EAA F1LFU00	3/35
ABE 7ACC12	5/15	ABE 7P16T214	5/14	AM0 2CA 001V000	3/41	BMX P34 2010	1/9, 3/39	TCS EAM 0100	3/35
ABE 7ACC20	5/17	ABE 7P16T215	5/14	AR1 SB3	5/17		and 3/43	TCS ECL 1M1M 10S2	3/35
ABE 7ACC21	5/17			B		BMX P34 2020	1/9, 3/22	TCS ECL 1M1M 1S2	3/35
ABE 7ACC30	5/17			BMX AMI 0410	2/31		and 3/43	TCS ECL 1M1M 1X5S2	3/35
ABE 7ACC80	5/17			BMX ANM 0600	2/31	BMX P34 2030	1/9, 3/22	TCS ECL 1M1M 40S2	3/35
ABE 7ACC81	5/17			BMX AMO 0210	2/31		and 3/43	TCS ECL 1M1M 5S2	3/35
ABE 7ACC82	5/17			BMX ART 0414	2/31	BMX RMS 008MP	1/9	TCS ECL 1M3M 10S2	3/35
ABE 7ACC83	5/17			BMX ART 0814	2/31	BMX RMS 008MPF	1/9	TCS ECL 1M3M 1S2	3/35
ABE 7ACC84	5/17			BMX CPS 2000	1/13	BMX RWS B000M	3/23	TCS ECL 1M3M 1X5S2	3/35
ABE 7ACC85	5/17			BMX CPS 2010	1/13	BMX RWS C016M	3/23	TCS ECL 1M3M 25S2	3/35
ABE 7BV10	5/17			BMX CPS 3020	1/13	BMX XBP 0400	1/15	TCS ECL 1M3M 3S2	3/35
ABE 7BV10E	5/17			BMX CPS 3500	1/13	BMX XBP 0600	1/15	TCS ECL 1M3M 40S2	3/35
ABE 7BV20	5/17			BMX DAI 1602	2/16	BMX XBP 0800	1/15	TCS ECL 1M3M 5S2	3/35
ABE 7BV20E	5/17			BMX DAI 1603	2/16	BMX XBP 1200	1/15	TCS ECL 1M3M 5S2	3/35
ABE 7CPA01	5/16			BMX DAI 1604	2/16	BMX XCA USB018	1/9 and	TCS MCN 3M4F3C2	3/45
ABE 7CPA02	5/16			BMX DAO 1605	2/16		4/31	TCS MCN 3M4M3S2	3/45
ABE 7CPA03	5/16			BMX DDI 1602	2/16	BMX XCA USB045	1/9 and	TLA CD CBA 005	3/40
ABE 7CPA11	5/16			BMX DDI 1603	2/16		4/31	TLA CD CBA 015	3/40
ABE 7CPA12	5/16			BMX DDI 3202K	2/16	BMX XEM 010	1/15	TLA CD CBA 030	3/40
ABE 7CPA13	5/16			BMX DDI 6402K	2/16	BMX XSP 0400	1/15	TLA CD CBA 050	3/40
ABE 7CPA21	5/16			BMX DDM 16022	2/17	BMX XSP 0600	1/15	TSX CAN CA100	3/40
ABE 7CPA31	5/16			BMX DDM 16025	2/17	BMX XSP 0800	1/15	TSX CAN CA300	3/40
ABE 7CPA31E	5/16			BMX DDM 3202K	2/17	BMX XSP1200	1/15	TSX CAN CA50	3/40
ABE 7CPA410	2/31 and			BMX DDO 1602	2/16	BMX XTS CPS10	1/13	TSX CAN CADD03	3/40
	5/16			BMX DDO 1612	2/16	BMX XTS CPS20	1/13	TSX CAN CADD1	3/40
ABE 7CPA412	2/31 and			BMX DDO 3202K	2/16	BMX XTS HSC 20	2/41	TSX CAN CADD3	3/40
	5/16			BMX DDO 6402K	2/16			TSX CAN CADD5	3/40
ABE 7FU012	5/17			BMX DRA 0805	2/16	F		TSX CAN CB100	3/40
ABE 7FU050	5/17			BMX DRA 1605	2/16	FTX BLA10	3/41	TSX CAN CB300	3/40
ABE 7FU100	5/17			BMX EHC 0200	2/41	FTX C78B	3/41	TSX CAN CB500	3/40
ABE 7FU200	5/17			BMX EHC 0800	2/36 and	FTX C78F5	3/41	TSX CAN CBDD03	3/40
ABE 7FU400	5/17				2/41	FTX C78M5	3/41	TSX CAN CBDD1	3/40
ABE 7FU630	5/17			BMX FCA150	2/31	FTX C78M5	3/41	TSX CAN CBDD3	3/40
ABE 7H08R10	5/11			BMX FCA152	2/31	FTX CM08B	3/41	TSX CAN CBDD5	3/40
ABE 7H08R11	5/11					FTX CM12B	3/41		
ABE 7H08R21	5/11								
ABE 7H08S21	5/11								

Product reference index

(continued)

TSX CAN CD100	3/40	X	
TSX CAN CD300	3/40	XBT Z938	3/45
TSX CAN CD50	3/40	XGS Z24	3/44
TSX CAN KCDF 180T	3/40	XZ CC12FCM50B	3/41
TSX CAN KCDF 90T	3/40	XZ CC12FDM50B	3/41
TSX CAN KCDF 90TP	3/40	XZ CC12MCM50B	3/41
TSX CAN TDM4	3/40	XZ CC12MDM50B	3/41
TSX CRJMD 25	4/31		
TSX CSA 100	3/45		
TSX CSA 200	3/45		
TSX CSA 500	3/45		
TSX CUSB 485	4/31		
TSX PCX 1031	4/31		
TSX SCA 50	3/44		
TSX SCA 62	3/44		
TSX SCP CM 4530	3/45		
TWD XCA ISO	3/44		
TWD XCA RJ003	3/45		
TWD XCA RJ010	3/45		
TWD XCA RJ030	3/45		
TWD XCA T3RJ	3/44		

U

UNY SDU MFF CD20	4/37
UNY SDU MFT CD20	4/37
UNY SDU MFU CD20	4/37
UNY SMU ZUCD30	4/39
UNY SPU EFF CD 30	4/30
UNY SPU EFG CD 30	4/30
UNY SPU EFT CD 30	4/30
UNY SPU EFU CD 30	4/30
UNY SPU EZF CD 30	4/30
UNY SPU EZG CD 30	4/30
UNY SPU EZT CD 30	4/30
UNY SPU EZU CD 30	4/30
UNY SPU LFF CD 30	4/30
UNY SPU LFG CD 30	4/30
UNY SPU LFT CD 30	4/30
UNY SPU LFU CD 30	4/30
UNY SPU LZF CD 30	4/30
UNY SPU LZG CD 30	4/30
UNY SPU LZT CD 30	4/30
UNY SPU LZU CD 30	4/30
UNY SPU MFG CD 30	4/30
UNY SPU MFT CD 30	4/30
UNY SPU MFU CD 30	4/30
UNY SPU MZG CD 30	4/30
UNY SPU MZT CD 30	4/30
UNY SPU MZU CD 30	4/30
UNY SPU SFG CD 30	4/30
UNY SPU SFT CD 30	4/30
UNY SPU SFU CD 30	4/30
UNY SPU SZG CD 30	4/30
UNY SPU SZT CD 30	4/30
UNY SPU SZU CD 30	4/30
UNY SPU ZFU CD 30E	4/33
UNY UDE VFU CD21E	4/30
UNY USE 909 CD M	4/31
UNY XCA USB 033	4/31

V

VW3 A8114	3/44
VW3 A8 306	3/45
VW3 A8 306 D30	3/45
VW3 A8 306 R03	3/45
VW3 A8 306 R10	3/45
VW3 A8 306 R30	3/45
VW3 A8 306 RC	3/45
VW3 A8 306 TF03	3/44
VW3 A8 306 TF10	3/44
VW3 CAN A71	3/41
VW3 CAN CARR03	3/41
VW3 CAN CARR1	3/41
VW3 CAN KCDF 180T	3/41
VW3 CAN TAP2	3/40



Platform for machine manufacturers
Modicon M340
 Unity software



Platform for machines and manufacturing processes
Modicon Premium
 Unity and PL7 software



Platform for continuous and semi-continuous industrial processes and infrastructure sites
Modicon Quantum
 Unity, Concept and ProWORX 32 software

The efficiency of Telemecanique branded *solutions*

Used in combination, Telemecanique products provide quality solutions, meeting all your **Automation** and **Control** applications requirements.



A worldwide presence

Constantly available

- More than 5 000 points of sale in 130 countries.
- You can be sure to find the range of products that are right for you and which complies fully with the standards in the country where they are used.

Technical assistance wherever you are

- Our technicians are at your disposal to assist you in finding the optimum solution for your particular needs.
- Schneider Electric provides you with all necessary technical assistance, throughout the world.

www.telemecanique.com

Schneider Electric Industries SAS

Head Office
 89, bd Franklin Roosevelt
 92506 Rueil-Malmaison Cedex
 France

www.schneider-electric.com
www.telemecanique.com

Due to evolution of standards and equipment, the characteristics indicated in texts and images of this document do not constitute a commitment on our part without confirmation.
 Design: Schneider Electric
 Photos: Schneider Electric
 Printed by:

Simply Smart !